

EFFECTIVE MIXING METHOD FOR STABILITY OF AIR CONTENT IN FRESH MORTAR OF SELF-COMPACTING CONCRETE IN TERMS OF AIR DIAMETER

Sovannsathya RATH*, Masahiro OUCHI**

*Kochi University of Technology

**Kochi University of Technology

ABSTRACT: To reduce the unit cost of self-compacting concrete (SCC), the powder content is considered to be reduced in this study. A new type of SCC, named as air-enhanced self-compacting concrete (air-SCC), with higher water to cement ratio and higher fine aggregate to mortar ratio than the conventional SCC is produced. With the target air content of about 10%, the quality control of air entrainment is indispensable. The purpose of this study is to introduce a mixing method which is efficient and effective in producing a stable air entrainment. Experiments were conducted with self-compacting mortar. Three types of mixing method were tested. These mixing methods were different by the order of pouring the mixing water, superplasticizer (SP), and air entraining agent (AE). Two mixing methods, in which SP and AE are separated, resulted in considerably improving the stability of entrained air. Moreover, both mixing methods produced higher percentage of air volume with small size air bubbles, compared to that of a conventional mixing method. Among these mixing methods, a mixing method in which SP and all the mixing water were poured at first then followed by adding AE, was effective in assuring the stability of entrained air.

KEYWORDS: self-compacting concrete, fresh mortar, mixing method, stability, air distribution, air diameter

1. INTRODUCTION

Self-compacting concrete (SCC) was first developed in the late 1980's with the name of self-compacting high performance concrete. SCC is a flowable concrete which is able to be compacted into the formwork purely by its own weight without the requirement of any vibrators. SCC is indispensable in case of the congested reinforcement and complicated shape of the formworks. Despite of these advantages, the high unit cost has limited the demand for SCC in construction. For instance, SCC is only about 5% of the total concrete demand in Japan. This is mainly related to the use of higher powder content in SCC than in the conventional vibrated concrete. To reduce the unit cost of SCC,

the author aims to reduce the powder content by increasing the water to powder ratio (W/P). By keeping the volume of coarse aggregate constant in the mix-proportion of SCC, increasing W/P means to increase the fine aggregate content. This will increase the interaction between the coarse aggregate and mortar. When this interaction is increased, the self-compactability of SCC is lowered. In order to improve the self-compactability of SCC, the author aims to introduce higher entrained air into SCC.

1.1 Air-Enhanced Self-Compacting Concrete

A new type of SCC with air content of about 10% is aimed to be produced to reduce the unit cost of SCC while maintaining the self-compactability. It is named as air-enhanced self-compacting concrete

(air-SCC). Fig. 1 shows the volume portion of the concrete composition of the conventional vibrated concrete (VC), SCC, and air-SCC. It can be seen that the cement content in the case of air-SCC, is similar to that of VC, which is about two times lower than that of SCC.

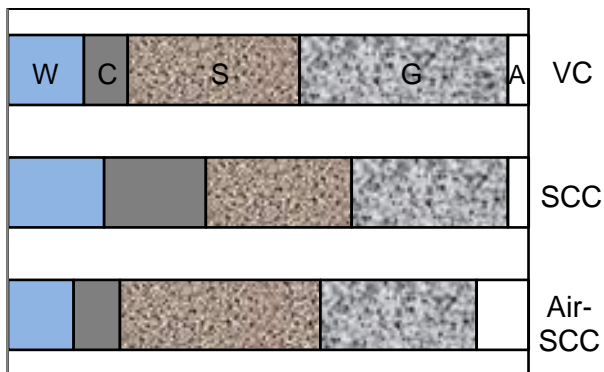

Fig. 1: Volume portion of water (W), cement (C), fine aggregate (S), coarse aggregate (G), and air (A) in conventional vibrated concrete (VC), self-compacting concrete (SCC), and air-enhanced self-compacting concrete (air-SCC)

Table 1 gives the mix-proportion for 1m^3 of concrete volume for SCC and air-SCC. In air-SCC, a stable air entrainment which may work as a ball bearing may play an important role in achieving the same target level of self-compactability as SCC.

Table 1: Mix-proportion of SCC and air-SCC

	(Kg/ 1m^3 of concrete volume)			
	Water *	Cement	Fine aggregate	Coarse aggregate
SCC ¹	192	641	708	804
Air-SCC ²	158	352	884	804

*including superplasticizer and air-entraining agent

¹ W/C=30%, s/m=40%, air content of 4%

² W/C=45%, s/m=55%, air content of 10%

1.2 Objective of Research

With the target air content of about 10% in concrete, the quantity and quality control of air entrainment is indispensable. Previous studies have reported the

difficulty in controlling the stability of air entrainment especially with SCC. Some have explained that, in highly flowable concrete, the air voids are able to move freely resulted in high risk of coalescence and rupturing of air bubbles.

Fig. 2 shows the relationship between initial air content and variation in air content in 2 hours in fresh mortar. The experiment was conducted with various types of air-entraining agent (AE). It can be seen that higher initial air content, which usually accompanied with higher dosage of AE, resulted in higher loss of air. Since the target air content in concrete is about 10% and the coarse aggregate is fixed as 30% of concrete volume, the target air content in mortar is about 15%. As it can be seen in the Fig. 2, with this target initial air content, the loss of air content in 2 hours was varied from around 4% to 8%. This dramatic loss of air showed that the alternative choice of AE types did not considerably improve the quality of air entrainment.

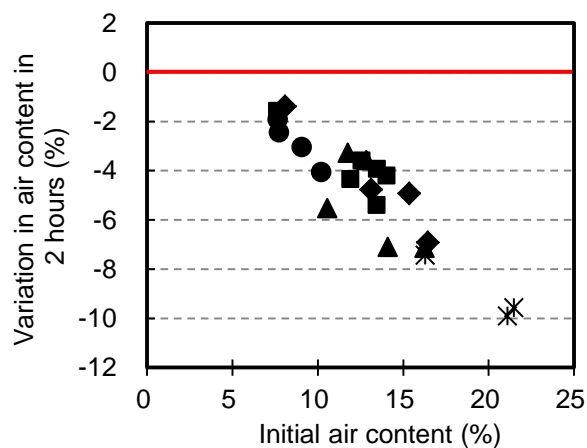

Fig. 2: The loss of air content in 2 hours in fresh mortar with various types of AE (Different shape means different types of AE)

The objective of this study is to introduce an effective mixing method, which is able to control the stability of air, and to clarify the effect of air diameter on the effectiveness of mixing method.

2. EFFECTIVE MIXING METHOD FOR STABILITY OF AIR CONTENT

2.1 Hypothesis

The difficulty in assuring the stability of air entrainment in SCC may contribute to the use of both the superplasticizer (SP) and the air-entraining agent (AE) at the same time. Some studies have reported that with the present of SP, higher dosage of AE was required to get the same air content as the mix without SP. The present of these two admixtures may interrupt the influence of one another resulting in lowering the quality of air entrainment and the workability of the mixture itself. Therefore, the author aims to introduce an effective mixing method in which each composition of the mix (especially SP and AE) is put at the right time to be able to reach the optimum effectiveness.

To be able to propose the best fit mixing method, it is indispensable to fully understand the mechanism of SP and AE. First chemical admixture, SP, is a kind of water-reducing agent which works as cement dispersants through electro-steric repulsive force. Electro-steric dispersion is a combination of electrostatic dispersion and steric dispersion. This dispersion is created by the adsorption of the ions on the cement particle, gives a slight negative charge as well as creates a layer on the surface of the particles. Second chemical admixture, AE, is a group of surfactants which reduce the surface tension at air-water interface. AEs help stabilizing the micro air bubbles formed during the mixing process. The hydrophobic end of AE (tail) is attracted to the air and the hydrophilic end (head, usually negatively charged) orients itself towards the water. This action form a water-repelling film on air bubbles and the negative charged disperse air bubbles from each other. Without including other chemical admixture action, AE normally adheres itself to the charged

surface of cement and aggregate particles. So, what will happen when a mixture containing both SP and AE?

Fig. 3 shows the mechanism of SP and AE working in the same mix. With the present of SP, the air content tends to be reduced. The negative charged on cement particles, given by the adsorption of SP molecules, prevent or lower the adsorption of AE molecules. As a result, there is less space for air bubbles to be entrained. Also, the negative charge keeps cement particles and air bubbles dispersing from each other and then reduces the friction of the mix. Besides the chemical property of SP and AE, the mixing procedure may also influence on its mechanism. In fact, when SP and AE are poured and mixed at the same, the mechanism of these two admixtures may become more complicated. To some level, the admixtures may disturb the effectiveness of each other resulting in both poor workability of the fresh mixture and poor stability of air entrainment.

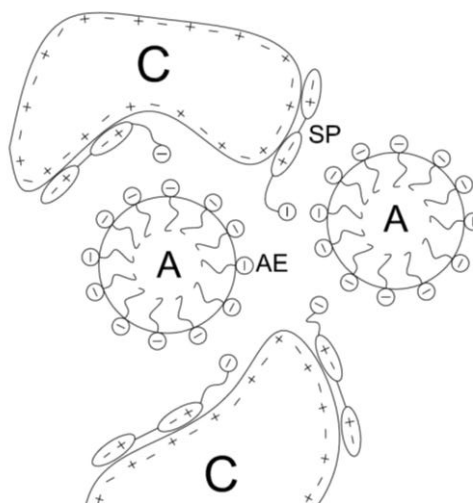

Fig. 3: The mechanism of SP and AE

By considering these phenomena, the author had proposed a hypothesis that by firstly introducing SP and mixed before introducing AE, is beneficial to allow SP to disperse the particles to its optimum level. Also, after pouring and mixing AE, the lower

initial air content may be obtained but by holding a better stability of air entrainment.

2.2 Water-dividing mixing method

2.2.1 Experiments

Two mixing methods as shown in Fig.4 were conducted in this section. In simple mixing method (Simple), the fine aggregate and the cement were firstly mixed for 30 seconds. Then, all the mixing water, superplasticizer (SP), and air-entraining agent (AE) were added and mixed for another 2 minutes. In water-dividing mixing method (W.D), the mixing water was divided into two parts so that the first part can incorporate with SP and the rest part with AE. In this mixing method, after the fine aggregate and the cement were mixed for 30 seconds, the first part of mixing water and SP were added and mixed for 1 minute. And finally, the rest part of mixing water and AE were poured and mixed for another 1 minute. The first part of mixing water was fixed at 20% of cement content by weight.

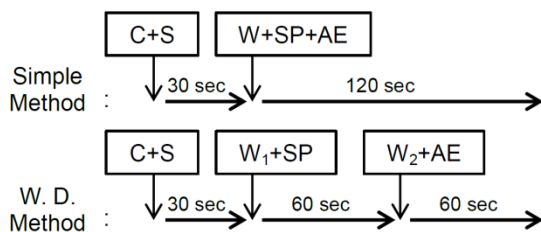

Fig. 4: Mixing procedure of the simple mixing method and the water-dividing mixing method;

S: fine aggregate, C: cement, W: water,

SP: superplasticizer, AE: air entraining agent,

$W = W_1 + W_2$, $W_1 = 20\%$ of cement weight

Experiments were conducted with mortar. The materials used and the mix-proportion in this chapter are shown in Table 2 and 3 respectively. The main composition of mortar includes: ordinary Portland cement, crushed limestone sand, polycarboxylic based superplasticizer, and two types of air-entraining agent (alkyl ether-based and Vinsol

resin). The water to cement ratio (W/C) and the fine aggregate to mortar ratio (s/m) were fixed at 45% by weight and 55% by volume respectively. The dosage of SP was constant and the dosage of AE was varied.

Table 2 Materials used for mortar

Cement (C)	Ordinary Portland cement (3.15g/cm ³)	
Fine aggregate (S)	Crushed limestone sand (2.68g/cm ³ , F. M. 2.73)	
Superplasticizer (SP)	SP1	Polycarboxylic based with viscosity agent and retarding type
Air entraining agent (AE)	AE1	Alkyl ether-based anionic surfactants
	AE2	Vinsol resin

Table 3 Mix-proportion of mortar

W/C	45% by weight
s/m	55% by volume
SP1/C	1.4% by weight
AE1/C	0.005%, 0.06% by weight
AE2/C	0.016%, 0.24% by weight

2.2.2 Results and analysis

Fig. 5 shows the relationship between dosage of AE and initial air content produced by the simple mixing method (simple) and the water-dividing mixing method (W. D.).

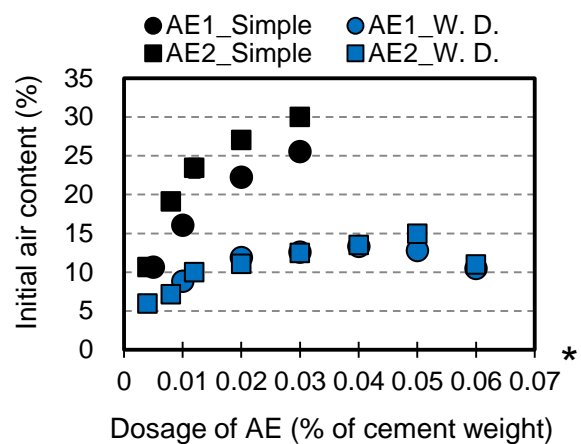

Fig. 5: Effect of water-dividing mixing method (W. D.) on initial air content (*dosage of AE \times 4 in case of AE2)

It can be seen that the W.D method produced considerably lower air content than that of the simple method with both types of AE. This result showed that by introducing SP as in case of the W. D. method, air entrainment condition seemed to be closely related to the above mechanism shown in Fig. 3. This process caused the reduction in the friction between particles, and as the result when AE was poured and mixed, lower content of air were able to be produced. Also, the lower content of air may also contributed to the shorter mixing time AE itself, which was only 1 minute in case of W. D. method while it was 2 minutes in case of the simple method.

Fig. 6 shows the relationship between dosage of AE and the variation in air content in 2 hours. The negative value means the air loss.

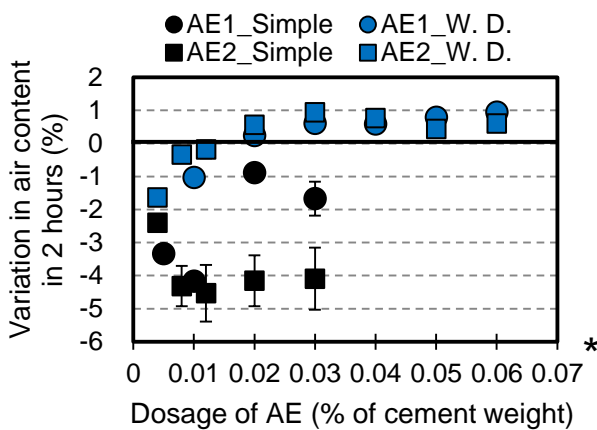

Fig. 6: Effect of water-dividing mixing method (W. D.) on stability of entrained air (*dosage of AE \times 4 in case of AE2)

It can be seen that the loss of air content was dramatic in case of the simple method and it was not properly improved with the increase dosage of AE. In contrast, with the W. D. method, the stability of air was considerably improved. The variation in air content from the initial state to 2 hours was very small. In case of the W. D. method, the improvement of stability can also be observed with the increase in dosage of AE. This result proved that with the same

dosage of AE agent, the lower the initial air content, the better the stability of air can obtained. This may be contributed by the higher percentage of small size air voids when using the W.D. method. Moreover, the shorter mixing time with AE of only 1 minute in case of the W. D. method may also keep the efficiency of AE in stabilizing the air entrainment.

Finally, it can be concluded that the mixing method had a significant influence on the stability of entrained air and also the air content itself.

2.3 Effective mixing method

2.3.1 Experiments

Even though the W. D. method is already efficient in producing a better stability of entrained air, but the dividing of mixing water was not favorable for the ready-mixed concrete plant or in the real construction site. Therefore, the mixing procedure was further modified to find an effective mixing method which is able to control the stability of air and more practical. In this chapter, three mixing methods as shown in Fig. 7 were conducted.

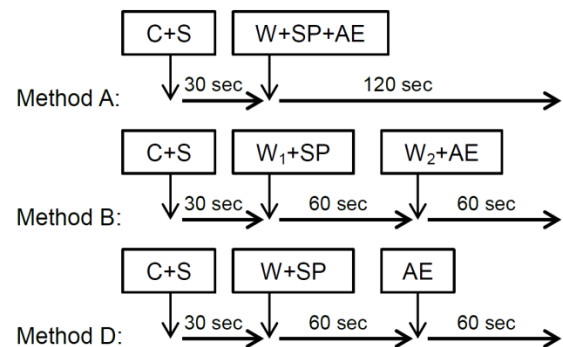

Fig. 7: Three types of mixing method for mortar;

S: fine aggregate, C: cement, W: water, SP: superplasticizer, AE: air entraining agent, $W = W_1 + W_2$, $W_1 = 20\%$ of cement weight

The simple method and the W. D. method were named here as method A and B respectively. The third mixing method was method D in which SP and AE were separated but the mixing water was not

divided. In this mixing method, after the cement and the fine aggregate were mixed for 30 seconds, all the mixing water and SP were added and mixed for 1 minute. Finally, AE was poured and mixed for the last 1 minute.

The materials used and the mix-proportion in this chapter are shown in Table 4 and 5 respectively. The main composition of mortar includes: ordinary Portland cement, crushed limestone sand, polycarboxylic based superplasticizer, and alkyl ether-based air-entraining agent. The water to cement ratio (W/C) and the fine aggregate to mortar ratio (s/m) were fixed at 45% by weight and 55% by volume respectively. The dosage of SP was constant and the dosage of AE was varied.

Table 4 Materials used for mortar

Cement (C)	Ordinary Portland cement (3.15g/cm ³)	
Fine aggregate (S)	Crushed limestone sand (2.68g/cm ³ , F. M. 2.73)	
Superplasticizer (SP)	SP2	Polycarboxylic based with viscosity agent
Air entraining agent (AE)	AE1	Alkyl ether-based anionic surfactants

Table 5 Mix-proportion of mortar

W/C	45% by weight
s/m	55% by volume
SP2/C	1.2% by weight
AE1/C	0.005%, 0.05% by weight

2.3.2 Results and Analysis

Fig. 8 shows the relationship between the dosage of AE and the initial air content produced by mixing method A, B, and D. Method A produced the highest initial air content then the rest mixing methods at any dosage of AE. Among these mixing methods, the initial air content produced by method B and D reached a saturated zone at the value of only 8.1% and 12.8% respectively. These initial air contents were not able to be further increased with higher

dosage of AE. The difficulty in entraining high air content was occurred with the method B and D both in which SP and AE were separated. The introduction of SP before AE, allowed the cement particles to disperse from each other by holding a slight negative charged which prevented the adsorption of AE molecules on the particles. As the result, there was less space for entrained air to be created.

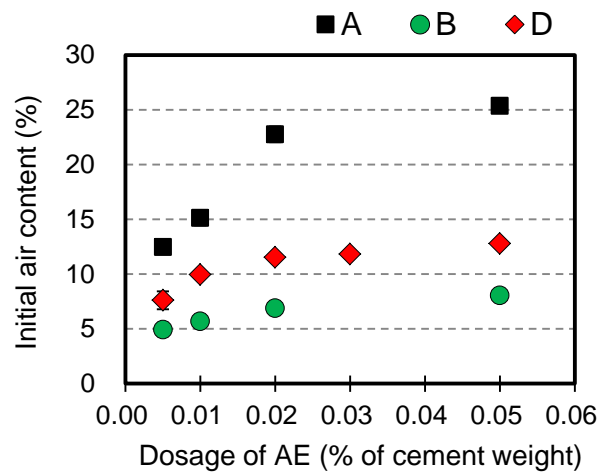

Fig. 8: Effect of different mixing methods on initial air content

Fig. 9 shows the relationship between the AE dosage and the variation in air content in 2 hours.

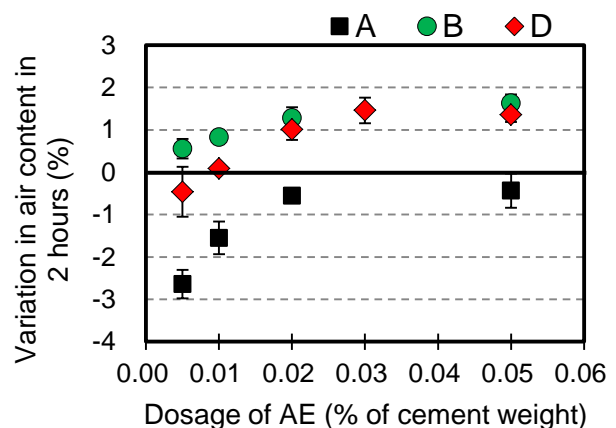

Fig. 9: Effect of different mixing methods on stability of entrained air

Among these mixing methods, mixing method B and D produced a better stability of air with an

improvement when the dosage of AE was increased. This improvement was due to the reduction in the friction of the mixture as SP was introduced. At the time AE was introduced, the well dispersed mixture allowed a better air entrainment to be created.

This result proved that the mixing methods in which SP was poured at first and then followed by AE were efficient in entraining a more stable air entrainment. Furthermore, the mixing method in which all the mixing water and SP were poured and mixed at first 1 minute, then followed by pouring AE and mixed for the last 1 minute was the effective method.

3. SUITABLE AIR DIAMETER FOR STABILITY OF AIR

3.1 Hypothesis

It was concluded in the previous chapter that the mixing method had a significant influence on the stability of entrained air. Since the measurement was based on quantitative judgment, further clarification is needed. Therefore, the measurement of air distribution in hardened stated was conducted following the ASTM C 457-98, standard test method for microscopical determination of parameters of the air-void system in hardened concrete, procedure A. The author expected that a more stable air entrainment was a result of a larger percentage of small size air bubbles.

3.2 Experiments

The mixing methods chosen for this chapter were method A, B and D. The mixing procedures of these methods were shown in Fig. 7.

Materials used and mix-proportion in this chapter are shown in Table 6 and 7 respectively. The main composition of mortar includes: ordinary

Portland cement, crushed limestone sand, superplasticizer of polycarboxylic based, and air-entraining agent of Vinsol resin. The water to cement ratio (W/C) and the fine aggregate to mortar ratio (s/m) were fixed at 45% by weight and 55% by volume respectively. The dosage of SP was fixed constant and the dosage of AE was varied.

Table 6 Materials used for mortar

Cement (C)	Ordinary Portland cement (3.15g/cm ³)	
Fine aggregate (S)	Crushed limestone sand (2.68g/cm ³ , F. M. 2.73)	
Superplasticizer (SP)	SP2	Polycarboxylic based with viscosity agent
Air entraining agent (AE)	AE2	Vinsol resin

Table 7 Mix-proportion of mortar

W/C	45% by weight
s/m	55% by volume
SP2/C	1.4% by weight
AE2/C	0.04% and 0.20% by weight

3.3 Results and analysis

3.3.1 Fresh state

Fig. 10 shows the relationship between the dosage of AE and the initial air content of mixing method A, B, and D. At any dosage of AE (0.04% or 0.20%), initial air content produced by method A was largely higher than that produced by method B or D.

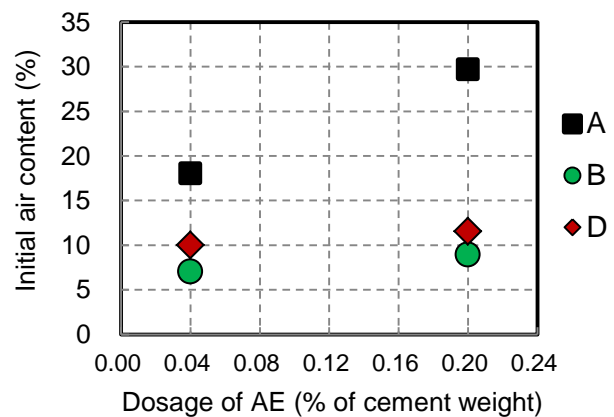

Fig. 10: Initial air content at the same dosage of AE produced by method A, B, and D

Fig. 11 shows the relationship between the dosage of AE and the variation in air content in 2 hours. At any dosage of AE, the stability of air with method A was very poor compared to that with method B or D.

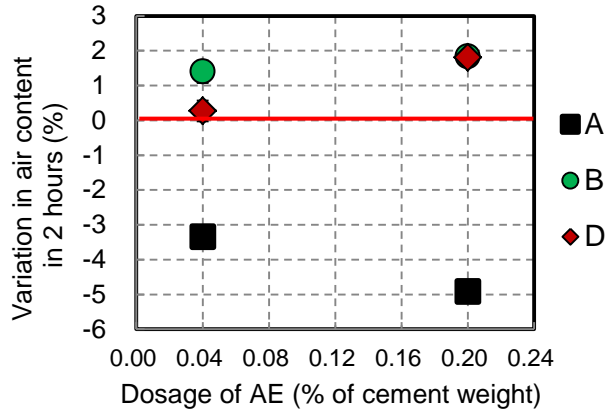

Fig. 11: Air stability at the same dosage of AE produced by method A, B, and D

3.2.2 Hardened state

To better understand air entrainment of method A, B and D, these six samples were casted in the cylinder mold with diameter of 100mm and height of 200mm. Three pieces were extracted from each sample at three positions (top, middle, and bottom). The thickness of each piece was 50mm. Both base side of each piece were polished and gently cleaned before the microscopical air distribution test. The results obtained from linear transverse method of each sample are shown in Table 8.

Table 8: Air distribution properties of each sample

Name of sample	Air content (%)	Specific surface (mm ² /mm ³)	Spacing factor (mm)
AE0.04%-A	12.8	14.79	0.243
AE0.04%-B	7.1	17.35	0.299
AE0.04%-D	10.6	14.65	0.295
AE0.20%-A	22.0	15.69	0.079
AE0.20%-B	8.8	22.38	0.140
AE0.20%-D	12.0	18.02	0.131

Each value was the mean value from the top, middle, and bottom part of the sample. Three important parameters of air distribution are the total air content, specific surface, and spacing factor.

The correlation between the air content tested at fresh state in 2 hours and the air content tested at hardened state by linear transverse method is shown in Fig. 12. The correlation coefficient was 0.99 and the slope value of the linear line was 0.89. This result showed that there was a negligible variation in air content from 2 hours until hardened state.

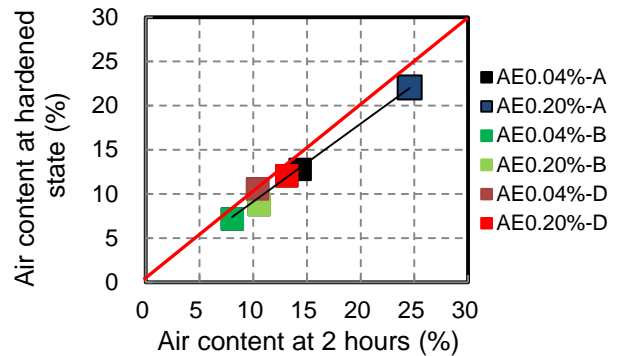

Fig. 12: Correlation between air content at 2 hours and air content at hardened state

Fig. 13 shows the air distribution of three samples using method A, B, and D at AE dosage of 0.04% of cement weight.

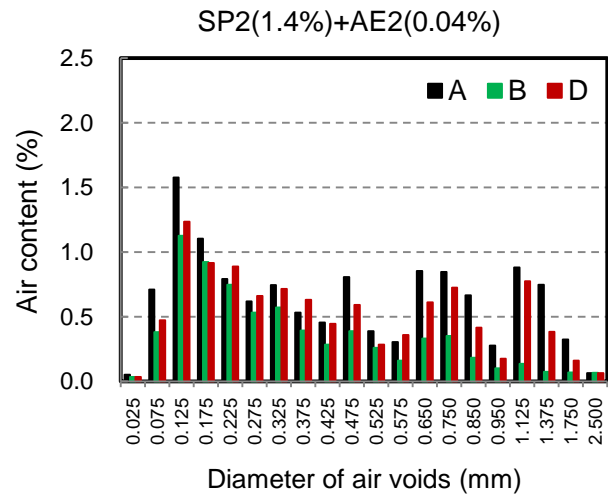

Fig. 13: Air distribution of mortar samples with the same mix-proportion at AE dosage of 0.04% (of cement weight) of mixing method A, B and D

The total content of air was 12.8%, 7.1%, and 10.6% in case of method A, B, and D respectively. The major content of air was of bubbles diameter between 100 μ m to 150 μ m. Among these three mixing methods, method B produced better air entrainment since the content of air with diameter larger than 800 μ m were observed to be smaller than the other two methods.

Fig. 14 shows the air distribution of three samples using method A, B, and D at AE dosage of 0.20% of cement weight. The total content of air was 22.0%, 8.8%, and 12.0% in case of method A, B, and D respectively. It can be seen that the major content of air is of bubbles diameter between 100 μ m to 150 μ m. Among these three mixing methods, method A which produced the highest air content possesses a large content of air at larger air bubble diameter. It proved that with simple method, when dosage of AE increase, there has no improvement in air distribution beside the dramatic increase in the total air content at especially the large size of bubbles. On the other hand, the air entrainment using method B or D were improved when the dosage of AE increased from 0.04% to 0.20% of cement weight.

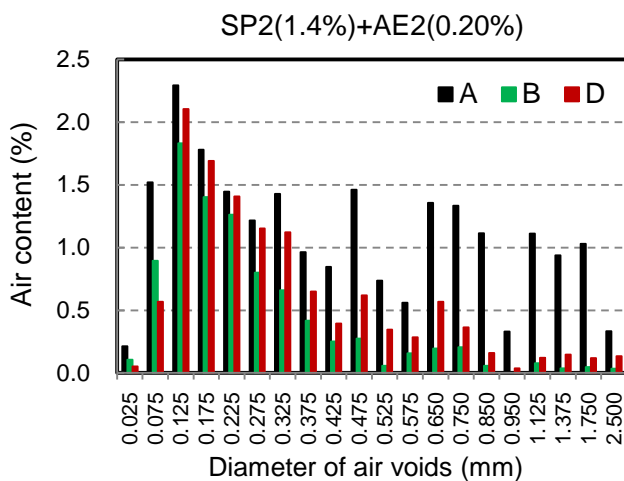

Fig. 14: Air distribution of mortar samples with the same mix-proportion at AE dosage of 0.20% (of cement weight) of mixing method A, B and D

Fig. 15 and 16 show respectively the share of the air volume and the share of the percentage of the air volume at five diameter ranges of air bubbles. In Fig. 15, when the dosage of AE was increased, air volume of each size bubbles was also increased in method A. In contrast, in method B or D, when the dosage of AE was increased, air volume of small size bubbles was increased whereas that of large size was reduced.

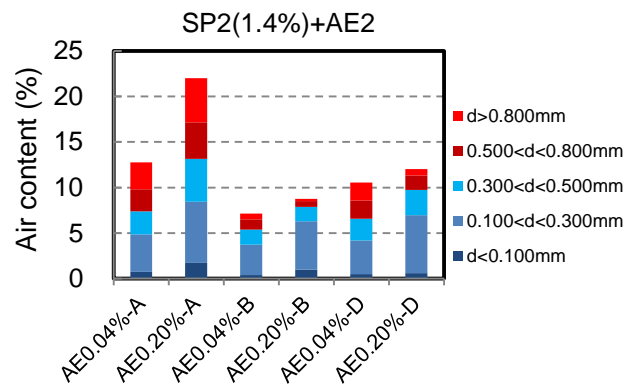

Fig. 15: Share distribution of the volume of air

Moreover, it was clear in Fig. 16 that, by method A, the share of percentage of air volume of each size air bubbles was not improved with the increase dosage of AE. In contrast, by method B or D, the share percentage of air volume of bubble size smaller than 300 μ m was increased whereas that of bubble size larger than 800 μ m was reduced.

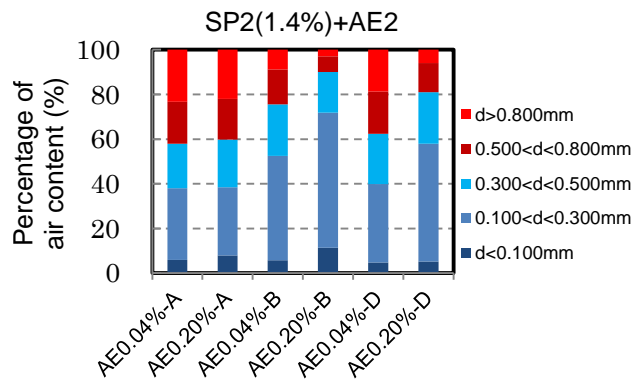

Fig. 16: Share distribution of the percentage of the air volume

Fig. 17 shows the relationship between air volume of bubbles diameter larger than $800\mu\text{m}$ and the stability of air. With a high correlation coefficient of 0.92, it was clear that the present of higher content of large size bubbles was harmful to the air stability.

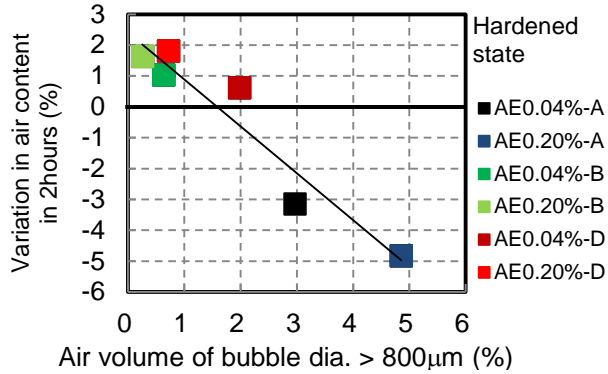

Fig. 17: Relation between stability of air and air volume (at hardened state) of bubble diameter larger than $800\mu\text{m}$

Since the air distribution was measured at hardened state, the content of air lost in the fresh state was not considered in Fig. 17 above. Therefore, in Fig. 18 by considering 50% of the lost air was with diameter larger than $800\mu\text{m}$, the correlation coefficient was increased to 0.97.

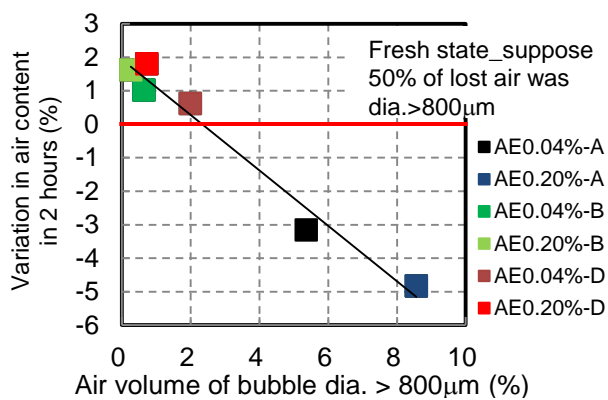

Fig. 18: Relation between stability of air and air volume at fresh state by considering 50% of the lost air was with bubbles diameter larger than $800\mu\text{m}$

In Fig. 19, by considering 100% of lost air was with diameter larger than $800\mu\text{m}$, the correlation coefficient was increased to 0.98. Even though the results in Fig. 18 and Fig. 19 were obtained by the

assumption, it was more likely that the larger size bubbles were less resistant than the smaller ones.

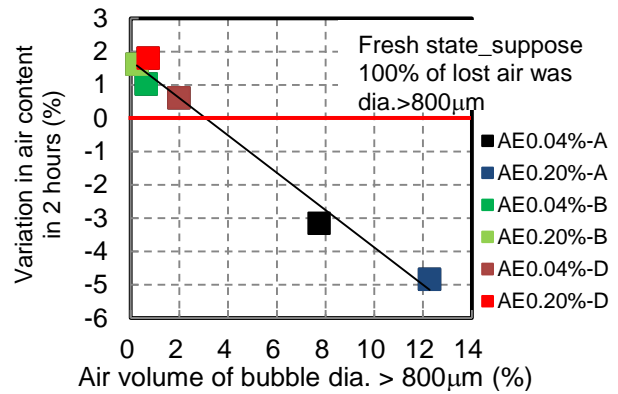

Fig. 19: Relation between stability of air and air volume at fresh state by considering 100% of the lost air was with bubbles diameter larger than $800\mu\text{m}$

These results proved that an efficient mixing method, which was able to improve the stability of entrained air, was in accompanied with the larger share percentage of air volume with small size air bubbles. The mixing method, which is able to eliminate the larger size bubbles, is more favorable in controlling the stability of air. The small size air void is more resistant than the larger one.

4. CONCLUSION

From the overall results and analysis above, conclusion can be written as the following:

1. Mixing method had a significant influence on the stability of entrained air.
2. A mixing method, in which superplasticizer and all the mixing water were poured and mixed at fist then followed by pouring AE, was an effective mixing method to control the stability of entrained air.
3. Mixing method was a significant parameter improving the air entrainment. A stable air entrainment was considerably related to high percentage of air volume with small size air bubbles.

REFERENCES

Du L. and Folliard J. K., 2005. Mechanism of air entrainment in concrete, *cement and concrete research, ELSEVIER*, 35: 1463-1471.

H. Okamura and M. Ouchi, 2003. Self-compacting concrete, *Journal of advanced concrete technology*, 1(1): 5-15.

Steven H. K. and Michelle L. W., 2011. *Design and control of concrete mixtures*, 15th edition, PCA.

ASTM C457-98, Standard test method for microscopical determination of parameters of the air-void system in hardened concrete.