

**Determination of FeS and FeS<sub>2</sub> Contents in the Suspension  
with Pt-Ag Twin-electrode by Electrochemical Method**

**Xiaojun Diao**

**A dissertation submitted to  
Kochi University of Technology  
in partial fulfillment of the requirements  
for the degree of**

**Doctor of Philosophy**

**Graduate School of Engineering  
Kochi University of Technology  
Kochi, Japan**

**September 2009**

**Determination of FeS and FeS<sub>2</sub> Contents in the Suspension with Pt-Ag Twin-electrode by Electrochemical Method**

**Xiaojun Diao**

Determination of FeS and FeS<sub>2</sub> Contents in the Suspension with  
Pt-Ag Twin-electrode by Electrochemical Method

Xiaojun Diao

A dissertation submitted to  
Kochi University of Technology  
in partial fulfillment of the requirements  
for the degree of

Doctor of Philosophy

Department of Engineering  
Graduate School of Engineering  
Kochi University of Technology  
Kochi, Japan

September 2009

## ABSTRACT

Due to sulfur pollution in marine, lacustrine and riverine sediments, sulfur compounds have been extensively studied for many years, but there have been few studies of insoluble sulfides in sediments. Recent studies have elucidated the importance of sulfide minerals as metal-binding components in anoxic sediments. Thus, the determination of sulfides is very important for the water quality survey.

Iron sulfides are important reductive pollutants in the sediment of water-body, such as a bay and a lake. The existence of iron sulfides has harmful influence upon the aquatic ecosystems, so that it is essentially necessary to monitor the iron sulfides content in the sediment. Acidification at high temperature is applied to the sediment for the determination of acid volatile sulfide (AVS), followed by a trap of hydrogen sulfide with metal solutions. Final measurements are normally carried out by colorimetry, gravimetry, potentiometry using ion-selective electrode, or photoionization detection (PID). These methods are accurate and sensitive for the determination of AVS, but they are time-consuming and tedious.

This thesis describes a new electrochemical method for the determination of FeS and FeS<sub>2</sub> respectively in the suspension samples with a platinum-silver (Pt-Ag) twin-electrode. The method needs fewer reagents and less manipulation of the sample, compared with previous methods, and can be performed readily by electrochemical processes. Though this work is still not effective in natural samples in the present stage, it will be contributed to the more improved methods for the determination of AVS and FeS<sub>(solid)</sub> in sediments.

The new electrochemical method has several procedures as described below. Because FeS and FeS<sub>2</sub> are insoluble in the water, it is difficult to directly detect the species by the electrochemical measurements. However, iron sulfide can be decomposed into soluble ferric ion and elementary sulfur by electrochemical oxidation with Pt electrode. After the electrolytic oxidation and several potential procedures, ferrous ion and sulfide ion were measured by voltammetry. The oxidation

potential and oxidation time with Pt electrode were decided from the dependencies of amounts of ferrous ion and sulfide ion on the potential condition. Furthermore, from relations of the peak charge of ferrous ion to the content of FeS or FeS<sub>2</sub>, linear calibration curves *a* and *b* were respectively prepared. According to the linear relations, the content of FeS or FeS<sub>2</sub> can be individually evaluated from the measurements of ferrous ion.

After the measurement of ferrous ion, ferrous ion and elementary sulfur were reduced with Pt electrode to remove ferrous ion and produce sulfide ion. With Ag electrode, silver sulfide was electrochemically deposited on electrode surface. A linear calibration curve *c* was prepared from a relation between the peak charge of silver sulfide and the FeS content. However, in the suspension of FeS<sub>2</sub>, silver sulfide was not able to be detected at all. According to the curve *c*, the content of FeS can be evaluated from the measurement of sulfide ion.

When this method was applied to the mixture suspension of FeS and FeS<sub>2</sub>, we checked whether the calibration curves *a*, *b* and *c* were suitable to estimate the contents of FeS and FeS<sub>2</sub>. The content of FeS can be determined by the curve *c* and the measurement of silver sulfide, because the addition of FeS<sub>2</sub> does not give an influence to the amount of silver sulfide. However the curves *a* and *b* were not effective in the mixture suspension because the slope of the curve *a* decreases gradually with the addition of FeS<sub>2</sub>. The content of FeS<sub>2</sub> will be determined if the total contents were estimated from the measurement of ferrous ion, because the content of FeS can be determined from the measurement of silver sulfide. Therefore, it will become important in future to combine the electrochemical determination method of the accurate total content of FeS and FeS<sub>2</sub> to this proposed method.

# TABLE OF CONTENTS

	Page
<b>ABSTRACT</b>	I
<b>TABLE OF CONTENTS</b>	III
<b>CHAPTER 1 INTRODUCTION</b>	1
<b>1.1 Research Background</b>	1
1.1.1 Sulfur Cycle in the Aquatic Sediments	2
1.1.2 Acid Volatile Sulfide (AVS)	5
1.1.3 Solid Phase Iron Sulfide of AVS in Sediments	7
<b>1.2 Determination of AVS in Sediments</b>	7
<b>1.3 Overview of this Thesis</b>	9
<b>CHAPTER 2 THE ELECTROOXIDATION OF IRON SULFIDE COMPOUNDS AT PLATINUM-SILVER TWIN ELECTRODE</b>	13
<b>2.1 Introduction</b>	13
<b>2.2 Experimental Section</b>	15
2.2.1 Twin Electrode	15
2.2.2 Reagents and Sample Preparation	16
2.2.3 Equipments	16
2.2.4 Electrooxidation Methodology	16
2.2.5 Result Evaluations	17
<b>2.3 Results and Discussion</b>	17
2.3.1 Mechanism for Generations of Ferric Ion and Elemental Sulfur from the Electrolytic Oxidation of Iron Sulfide	18
2.3.2 Dependencies of Generations of Ferrous Ion and Silver Sulfide on the Oxidation Potential	22

2.3.3 Dependencies of Generations of Ferrous Ion and Silver Sulfide on the Oxidation Time	26
2.3.4 Effect of Teflon Spacer Thickness on the Determination of Silver Sulfide in the Suspension	28
2.3.5 Effect of Surface Area of Twin Electrode on the Determination of Ferrous Ion and Silver Sulfide in the Suspension	30
<b>2.4 Conclusions</b>	<b>32</b>
<b>CHAPTER 3 DETERMINATION OF CONTENTS OF IRON MONOSULFIDE AND IRON DISULFIDE BY ANALYSIS OF FERROUS ION WITH TWIN ELECTRODE IN SUSPENSIONS</b>	<b>33</b>
<b>3.1 Introduction</b>	<b>33</b>
<b>3.2 Experimental Section</b>	<b>36</b>
3.2.1 Reagents and Sample Preparation	36
3.2.2 Apparatus	36
3.2.3 Electroanalysis Procedures	37
<b>3.3 Results and Discussion</b>	<b>38</b>
3.3.1 Identification of Ferrous Ion Peak Generated from Iron Sulfide in the Suspension	38
3.3.2 The Mechanism of Ferrous Ion Analysis in the Suspension by Linear Sweep Voltammetry with Twin Electrode	42
3.3.3 Optimization of the Linear Sweep Voltammograms for Ferrous Ion Analysis	42
3.3.4 Determination of Ferrous Ion from the Electrolytic Oxidation of Iron Sulfide in the Suspension	46
<b>3.4 Conclusions</b>	<b>51</b>
<b>CHAPTER 4 DETERMINATION OF IRON MONOSULFIDE BY ANALYSIS OF SULFIDE ION WITH TWIN ELECTRODE</b>	<b>52</b>

<b>IN SUSPENSIONS</b>	
<b>4.1 Introduction</b>	52
<b>4.2 Experimental Section</b>	53
4.2.1 Sample Preparation and Apparatus	53
4.2.2 Electroanalysis Procedures	54
<b>4.3 Results and Discussion</b>	55
4.3.1 Identification of Sulfide Ion Peak Generated from Iron Sulfide in the Suspension	55
4.3.2 The Mechanism of Sulfide Ion Analysis in the Suspension by Linear Sweep Voltammetry with Twin Electrode	58
4.3.3 Optimization of the Linear Sweep Voltammogram for Silver Sulfide Analysis	60
4.3.4 Effect of Iron Deposition at Pt Electrode Surface on the Determination of Silver Sulfide	65
4.3.5 Determination of Silver Sulfide from the Electrolytic Oxidation of Iron Monosulfide in the Suspension	69
<b>4.4 Conclusions</b>	73
<b>CHAPTER 5 DETERMINATION OF IRON MONOSULFIDE AND IRON DISULFIDE CONTENTS BY FERROUS AND SULFIDE ANALYSIS IN MIXTURE SUSPENSIONS</b>	75
<b>5.1 Introduction</b>	75
<b>5.2 Experimental Section</b>	76
5.2.1 Sample Preparation	76
5.2.2 Apparatus	76
<b>5.3 Results and Discussion</b>	77
5.3.1 Determination of the Contents of Iron Monosulfide and Iron Disulfide by Ferrous Ion Analysis in the Mixture Suspension	77
5.3.2 Determination of the Content of Iron Monosulfide by Sulfide	79



Ion Analysis in the Mixture Suspension	
<b>5.4 Conclusions</b>	<b>82</b>
<b>CHAPTER 6 CONCLUSIONS</b>	<b>83</b>
<b>6.1 Summary and Conclusions</b>	<b>83</b>
<b>6.2 Suggestions for the Future Research</b>	<b>87</b>
<b>REFERENCE AND NOTES</b>	<b>89</b>
<b>LIST OF PUBLICATION AND PRESENTATION</b>	<b>97</b>
<b>ACKNOWLEDGEMENT</b>	<b>98</b>

# CHAPTER 1

## INTRODUCTION

### 1.1 Research Background

With the rapid development of industry and agriculture, environmental pollution is rapidly increasing and attracted more and more attention from governments and researchers. Among these environmental problems, water pollution is one of the primary concerns due to its direct effect on the aquatic ecosystem and human health [1-3]. Sediments of lake and riverbed are the main part of aquatic ecosystem, which not only play an important role in influencing water pollution but can also provide a record of the water pollution history, because they act as both carriers and potential sources of contaminants in an aquatic environment. Contaminated sediments have been recognized as a very important deposit for persistent toxic substances (heavy metals and xenobiotic organic compounds) released into the aquatic environment from various sources [4-7].

Sulfur is one of the major components in seawater, which exhibits several oxidation states between +6 and -2 under natural aquatic conditions. Sulfur geochemical behavior is varied and complex, and is apt to be affected by aquatic conditions. Sulfur cycle in marine sediments has aroused growing interest by researchers in sediments, due to its effects on water O<sub>2</sub> content, pollutant toxicity and other elements cycles [8-10]. For example, iron and metals are released when their sulfides move into oxidizing sediment where they are unstable [11,12]. Heavy metals are the main pollutants in many water and sediment, which have caused many environmental events due to their toxic and carcinogenic effect. Sulfur plays an important role in deposition, dissolution and chelation of heavy metals, and affects environmental behavior of the heavy metals [13]. Therefore, it is necessary to study the change of

sulfur species in sediment in order to study pollutants behavior in aquatic system.

Various sulfur compounds are produced in sediments and iron sulfide is the most important reductive component among these sulfur compounds in aquatic sediment [14-17], including acid volatile sulfide (AVS) and pyrite ( $\text{FeS}_2$ ), which greatly affect the cycles of sulfur, carbon and bioavailability and potential mobility of trace elements [18-21]. Pyrite is the final product of the reaction of reduced sulfur with reactive iron, and is commonly found in ancient sedimentary rocks. AVS, which is commonly found in recent sediments, is considered to include amorphous iron monosulfide ( $\text{FeS}$ ), mackinawite ( $\text{FeS}_{1-x}$ ) and greigite ( $\text{Fe}_3\text{S}_4$ ). Many studies have concerned iron sulfide in sediment of bay and lake [14-17]. However, the determination of sulfur species in iron sulfide still has much difficulty, and this has negatively affected the progress in studying sulfur cycle in sediment and aquatic ecosystem. Therefore, the efficient and comprehensive methodology for the determination of iron sulfide needs to be developed.

### ***1.1.1 Sulfur Cycle in the Aquatic Sediments***

Elemental sulfur (S) is an intermediate produced through complex biogeochemical processes occurring in aquatic systems, which has various species, such as inorganic forms sulfates ( $\text{SO}_4^{2-}$ ), elementary sulfur ( $\text{S}^0$ ), metal sulfides (mainly  $\text{FeS}$ ) and pyrite ( $\text{FeS}_2$ ), and organic forms ester sulfate group and carbon-bonded sulfur compounds [22]. Change of sulfur species in aquatic sediments is affected by the combination of reductive and oxidative chemical and bacterial processes (see Figure 1.1) [23,24].

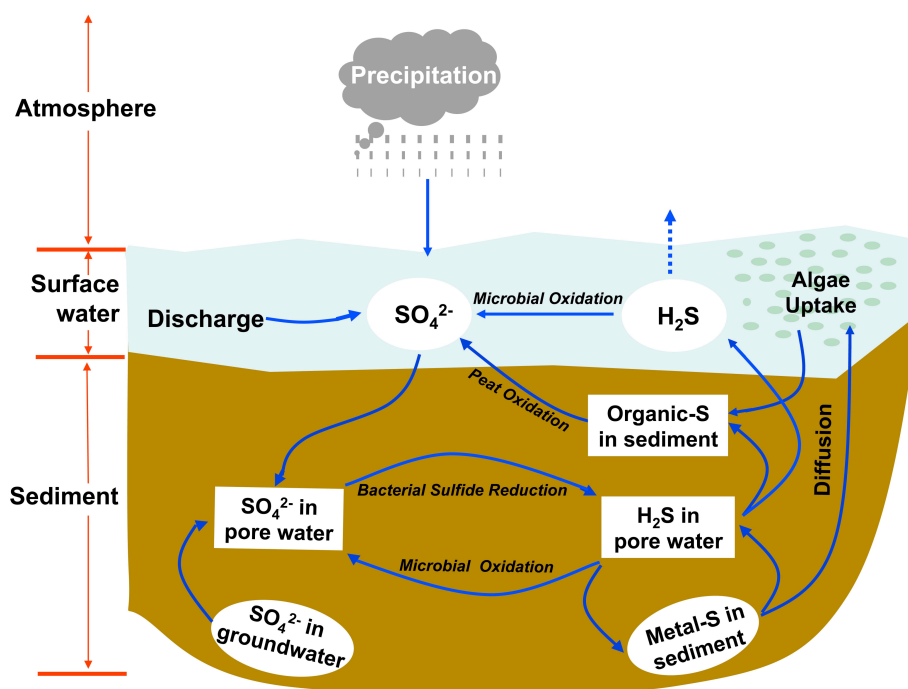


Figure 1.1 Sulfur cycle in the aquatic sediments

Sulfate reduction is the major mineralization pathway which accounted for 10–90% of the total organic matter degradation in sediments of productive coastal marine systems [23-28]. Reduced conditions are maintained in most aquatic sediments below a thin, oxidized surface layer because of the activity of heterotrophic organisms, which provides the basis for the transformation of inorganic sulfur compounds through a cyclic series of redox processes. Sulfate can be reduced to sulfide by the respiratory metabolism of sulfate-reducing bacteria [23]. In this process, dissolved hydrogen sulfide may quickly react with sedimentary reactive iron compounds to form iron monosulfide ( $\text{FeS}_x$ ) [29], which can react further with dissolved sulfide, elemental sulfur or polysulfides to form pyrite ( $\text{FeS}_2$ ) [30-32]. Immobilization of free sulfide in sediment has important effect on the cycling of iron and sulfur. Transport processes and turnover rates are significantly reduced by the formation of solid phase iron sulfides. Moreover, the formation of iron sulfides and the subsequent burial in the sediment has been recognized as the dominant pathway for the permanent removal of sulfur and iron [33,34]. Since hydrogen sulfide dissolved in the pore waters is toxic for

many macrofaunal species <sup>[35]</sup>, the fixation of H<sub>2</sub>S through the formation of metal sulfides is also an important detoxifying mechanism for the macrofauna community.

Although much sulfide is trapped by precipitation with metal ions in the sediment, any sulfide may dissolve in the pore water and reach the oxic and photic surface layers of the sediment. It is oxidized partly by a spontaneous chemical reaction and partly by catalysis by chemoautotrophic or photoautotrophic sulfur bacteria <sup>[36]</sup>. When reactive iron is not sufficient in sediment, H<sub>2</sub>S can diffuse into underlying sediments or the water column <sup>[37]</sup>, and is reoxidized to sulfur intermediates (elemental sulfur, thiosulfate, sulfite) or sulfate <sup>[38,39]</sup> or reacts with organic matter <sup>[40]</sup> through chemical and microbial oxidation <sup>[40]</sup>. In addition, iron sulfide minerals can be transported by bioturbating organisms from reduced sediment to oxidized sediments, where they are reoxidized subsequently <sup>[41-43]</sup>. Thus, the recycling of sulfur and iron in the sediments might be enhanced by bioturbating and bioirrigating activities of benthic organisms. Oxygen can directly affect sulfur and iron cycling through re-oxidation, and indirectly affect it through its influence on the biomixing and bioirrigating activity of the macrofauna that, in turn, depend on oxygen to respire.

These processes have a strong influence on the chemical environment in the sediment. They mediate a significant part of the energy flow in detritus food chains connected to anaerobic decomposition, and balance between oxygen and sulfide is an important factor for the distribution of benthic organisms <sup>[44]</sup>. In the early diagenesis of anoxic sediments, the transformations of inorganic sulfur also play a dominating role <sup>[45]</sup>.

Although it is well known to the microbial and biochemical process of sulfur, their quantitative importance is not paid much attention. The pool sizes of the various sulfur compounds have been determined frequently, their transformation rates are less estimated by direct methods. In general, the rate of sulfate reduction is calculated from the accumulation of metal sulfides, assuming complete precipitation of the H<sub>2</sub>S produced <sup>[46,47]</sup>. However, above method is not accurate, since many results showed that reduction rates are greatly underestimated <sup>[23]</sup>. Measurement of stable sulfur isotopes is an important aid in determining the origin of the various pools <sup>[46,47]</sup>.

However, it is difficult to obtain a dynamic picture of the sulfur cycle. Based on the gradient and diffusion of sulfate and on the sedimentation rate<sup>[48,49]</sup>, established a mathematical model, which is a good indirect method for determining the rate of sulfate reduction. However, the model implies steady state conditions which are only partly fulfilled in coastal environments. The chemical methods measuring sulfate or sulfides are not sufficiently when determining the small changes in concentration in isolated sediment samples during short term incubations. Therefore, a sensitive, accurate and reliable electrochemical technique is developed in this thesis for the determination of iron sulfides.

### ***1.1.2 Acid Volatile Sulfide (AVS)***

Acid volatile sulfide (AVS) usually means the sulfide produced through sediment acidification, and is operationally defined as reduced inorganic S that reacts with HCl to form H<sub>2</sub>S<sup>[50-52]</sup>. AVS includes amorphous iron monosulfide, mackinawite and amorphous monosulfides of other metals (nickel, zinc, cadmium, lead, copper, and perhaps mercury and silver)<sup>[53,54]</sup>, and is regarded as a major sorbent for several trace elements in anoxic sediments<sup>[55]</sup>. Several studies show that a relative abundance of reactive sulfides effectively sequesters reactive trace elements<sup>[56-58]</sup>, and that certain sulfide minerals are important as metal-binding components in anoxic sediments<sup>[59-62]</sup>.

Iron sulfide is primary one of the AVS and AVS can be equated to FeS<sup>[63]</sup>. The formation of iron sulfides begins with the oxidation of sulfate and organic matter by sulfate-reducing bacteria, which produces hydrogen sulfide (H<sub>2</sub>S) (see Figure 1.2). The abundant iron in natural sediments reacts with H<sub>2</sub>S to form iron sulfide minerals<sup>[64]</sup>.

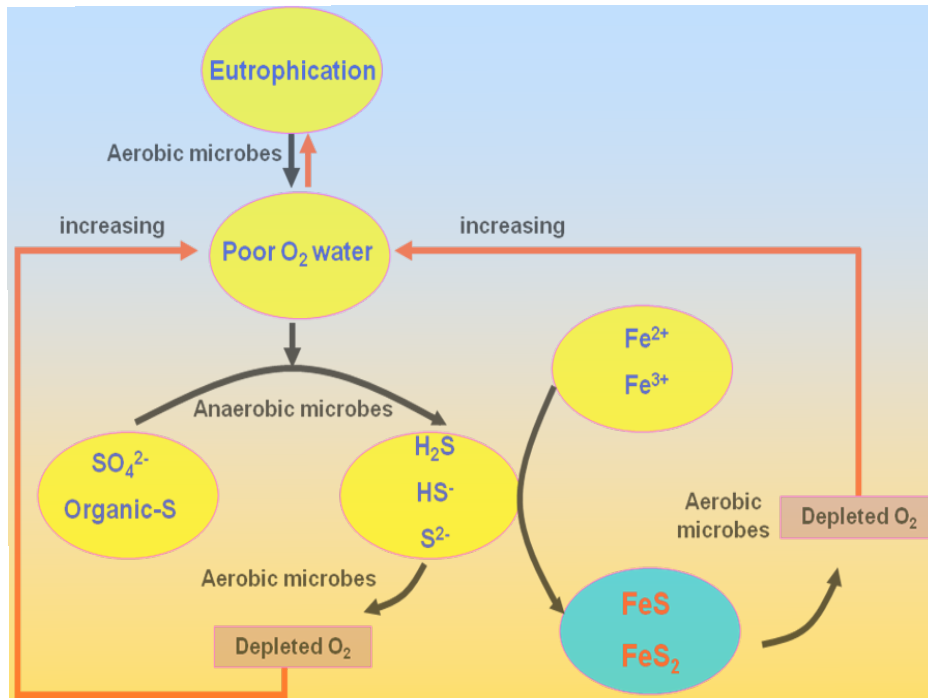


Figure 1.2 Formation of iron sulfides in sediments and its effect on aquatic ecosystem

Due to the fact that AVS is metastable and pyrite is the thermodynamically stable, over time, sedimentary FeS tends to be replaced by thermodynamically favoured pyrite<sup>[50]</sup>, but the replacement does not involve a literal “conversion” of FeS to pyrite<sup>[54]</sup>. Rather, over time, FeS dissolves and pyrite forms, resulting in increasing pyrite-S to AVS ratios<sup>[31]</sup>. Due to slow transformation rate, AVS may persist for long time in sediment<sup>[45,65]</sup>.

Determination of AVS attracts much attention since the quantity of AVS may be an indicator of potential metal toxicity in sediments. Di Toro et al.<sup>[60]</sup> proposed that potential metals toxicity may be determined by comparing the ratio of AVS with simultaneously extracted metals (SEM), which are the metals released during oxidation of anoxic sediment. However, up to now, the determination of AVS still suffers uncertainty when applied to different samples and using different reagents, resulting in either overestimation or underestimation of sulfur pools. This is due to the fact that, upon exposure to air, AVS is oxidized and rendered inert in the analytical

process. According to the previous reports, sampling from deep sediment, handling, storage and analysis are regarded as the main impact factors for the AVS determination. Therefore, these operations should adhere to stringent protocols.

### ***1.1.3 Solid Phase Iron Sulfide of AVS in Sediments***

The classical opinion is that AVS can be equated to FeS, which penetrates much recent literature and even is a keystone of the mass balances used in sedimentary isotope systematics. However, few references report the solid phase FeS in general marine systems <sup>[63]</sup>.

Rickard and Morse <sup>[63]</sup> review chemistry of sedimentary iron sulfide and conclude that acid volatile sulfide (AVS) as a model for FeS estimation should be abandoned. The possible reasons are that, firstly, it is not equivalent to FeS, since other metals are also incorporated in FeS via substitution and co-precipitation; secondly, extraction techniques are not always quantitative for known FeS minerals and may also extract various amounts of pyrite; thirdly, solid FeS phases have been rarely identified in sediments by instrumental methods. Fourth, organic S phases may also release H<sub>2</sub>S during acidification. For example, the solubility of FeS is poorly constrained and the use of solubility measurements to infer the presence of FeS is unreliable. So it would be better if the present AVS approach is dropped and the individual components of AVS, including solid phase FeS, are measured instead, and then this would be a preferred approach.

## **1.2 Determination of AVS in Sediments**

Determination of different forms of sulfide in AVS in sediment has previously been attempted using different techniques, such as colorimetry, gravimetry, ion-selective electrode and photoionization detection (PID). They show different advantages and shortcomings in determining AVS in sediments. For the choice of method, the



following factors should be considered, such as time consuming (efficiency), waste generation, cost, reproducibility and determination limit. All four methods are based on the conversion of the sulfide to  $H_2S$  by reaction with 1mol/L hydrochloric acid, the purge of  $H_2S$  in the system with a purified inert gas, and the trap of the evolved  $H_2S$ . The difference among them is the difference in trapping and quantifying  $H_2S$ . Sodium hydroxide (0.5M), silver nitrate (1M), sulfide antioxidant buffer (0.2M) and a column immersed in liquid nitrogen are used in colorimetry, gravimetry, ion-selective electrode and PID methods respectively. The trapping solutions or column are then analyzed for evolved  $H_2S$ , though shortcomings exist somewhat in these methods.

In order to compare these four methods, the cost, waste generation and convenience of each method should be considered. Cost refers to purchase permanent equipment and reagents. Waste generation refers to the amount of waste reagent that requires disposal. Convenience focuses on the analysis time per sample, the frequency of instrument repair and routine maintenance, and the complexity in operation.

The colorimetric method is relatively simple, less time-consuming and inexpensive. It has broad measurement extent, though dilution of the trapping solution is required for high AVS concentrations. Instrument repair and maintenance is seldom. The shortcoming is large acid waste (approximately 280ml per sample). The mixed diamine reagent used is the most hazardous in this method.

The gravimetric method is time-consuming, complicated and expensive (due to the expense of the silver nitrate). But the instrument expense used in this method is lower than that of the PID and colorimetric method, for only glassware and an accurate balance (precision 0.001g) are required. The measurement extent is less than that of the colorimetric method. Waste production is significantly larger than that of the colorimetric method (approximately 500ml per sample) because of the extra HCl-removal trap and the larger volume of trapping reagent.

The ion selective electrode method is the simplest and inexpensive in four methods. This method can determine a wide range of AVS concentrations without dilution of the trapping solution. It produces equal amount of waste as the colorimetric method (approximately 280ml per sample).

The photoionization detection (PID) method is relatively simple and highly accurate while is high cost. This method works well when the NaOH-trapping step is eliminated, but this step must be used for samples with concentrations greater than 10pmol/g, since the PID is linear only about 1pmol of H<sub>2</sub>S. NaOH occasionally experiences breakthrough, while seldom occur in other methods. Lower flow rates coupled with longer purge time, could eliminate this problem. PID method produces the smallest amount of waste (92ml per sample) among four methods, while was the most expensive in terms of instrument cost. In addition, measurement extent of PID is less and it is difficult to determine extremely high AVS.

### **1.3 Overview of this Thesis**

In this thesis, we propose a new technique to determine the contents of iron monosulfide and iron disulfide in suspensions respectively with platinum-silver twin-electrode by electrochemical techniques such as electrolytic oxidation and linear sweep voltammetry. The Pt-Ag twin-electrode is a newly developed electrode and has many superior physical and electronic properties, such as hardness, chemical inertness, reproducibility, high sensitivity and electrical conductivity. Compared to the previous analytic methods, this method has several advantages, such as easiness of sampling and process, simple and rapid operation, high sensitivity and precision, long-term reliability and reproducibility. After optimization of the experimental conditions, this method can effectively determine FeS in the mixture suspension. Moreover, we discuss the validity of proposed method in determining FeS and FeS<sub>2</sub> contents in the mixture suspension samples.

In Chapter 2, we use a Pt-Ag twin electrode to carry out the electrooxidation and voltammetry in the iron sulfide suspension to produce the electrochemically active species and determine the concentrations of generated ferrous ion and sulfide ion. Since solid phase iron sulfide is insoluble in water, it is difficult to electrolyze and determine it on the electrode surface directly. However, the electrochemically active

species can be generated from the electrolytic oxidation of iron sulfide sample in the suspension, and the linear sweep voltammetric determination of these species is readily performed using the newly developed platinum-silver twin-electrode. We report on the mechanism of generations of ferric ion and elemental sulfur from the electrolytic oxidation and the correlations between the generations of ferrous ion/sulfide ion and oxidation conditions such as oxidation potential and time. In addition, the optimal instrumental parameters of the twin electrode were discussed and finally decided to perform our electroanalysis procedure. This study provides the theoretical base for the detection of ferrous ion and sulfide ion generated from the electrolysis production of iron sulfide in the suspension by electrochemical method with Pt-Ag twin electrode.

In Chapter 3, the electrochemical method with Pt-Ag twin electrode was proposed to determine the contents of FeS and FeS<sub>2</sub> by ferrous ion analysis in the suspension. The ferric ion was generated from the electrolytic oxidation of iron sulfide and reduced to ferrous ion with the accumulation potential. In the various voltammetric processes, we investigated the mechanism of the ferrous ion analysis, and found that the ferrous ion is oxidized to ferric ion by the transfer of one electron, generating a measurable current which forms a well-defined oxidation peak in the negative scan of the voltammogram. After optimization of the conditions of linear sweep voltammograms such as the accumulation time and the scan rate, the correlations between the ferrous ion concentration and iron monosulfide wt% or iron disulfide wt% were studied for the quantificational analysis in the suspension. We found two linear relations between them. Two calibration curves were obtained for the analytical curves of the ferrous ion in the standard suspensions of FeS and FeS<sub>2</sub>, and according to this, the iron sulfide content can be evaluated from the measured concentration of ferrous ion.

In Chapter 4, we applied the Pt-Ag twin electrode to determine the FeS by sulfide ion analysis because the elemental sulfur was only generated from the electrolytic oxidation of FeS in the suspension. The oxidation production of FeS<sub>2</sub> from the electrolysis is polysulfur which is the thermodynamically stable form and can not be

reduced to the electrochemically active species in the proposed electroanalytic process. The generated elemental sulfur can be reduced to sulfide ion at the high negative potential so that we can determine the concentration of sulfide ion in the voltammetry. The mechanism of the sulfide ion analysis was studied and we found that the silver reacts with sulfide ion to form silver sulfide on the silver electrode surface in the deposition process. The silver sulfide is reduced to silver and sulfide ion in the subsequent voltammetric process by the transfer of two electrons, which generates a measurable current and forms a well-defined reduction peak in the positive scan of the voltammogram. Additionally, optimization of the linear sweep voltammograms for silver sulfide analysis was also investigated such as the deposition potential, the deposition time and the scan rate before the measurement of sulfide ion. The correlation between the iron monosulfide wt% and the concentration of sulfide ion generated from the elemental sulfur in the suspension was studied. We found a linear relation between them, and obtained a calibration curve. Therefore, the FeS content can be evaluated from the measured concentration of sulfide ion.

In Chapter 5, based on the results described in Chapter 3 and Chapter 4, the proposed methods were used to quantitatively analyze the FeS and FeS<sub>2</sub> in the mixture suspensions. According to voltammograms, we found that the traces of ferrous ion peak and sulfide ion peak can be detected by linear sweep voltammetry with our Pt-Ag twin electrode in mixture suspension samples. After electrooxidation of mixture sample on Pt electrode, solid iron sulfide was transformed into soluble ferric ion which generated from both FeS and FeS<sub>2</sub>, and elemental sulfur which generated only from FeS. We applied this electroanalytic procedure in three mixture suspension systems and obtained a good agreement between the measured FeS content and the reference value. According to the calibration curve *c*, we can determine the content of FeS from the measured concentration of sulfide ion. However, a deviation between the measured ferrous ion concentration and the reference value of the calibration curve *a* was observed in three systems of mixture suspension samples. Therefore, we can determine the FeS content by the measured

concentration of sulfide ion in the mixture suspension samples by our proposed electrochemical method with Pt-Ag twin-electrode.

Chapter 6 presents the conclusions of this thesis. Furthermore, some advices about future work were put forward for further research.

## CHAPTER 2

### THE ELECTROOXIDATION OF IRON SULFIDE COMPOUNDS AT PLATINUM-SILVER TWIN ELECTRODE

#### 2.1 Introduction

Analysis of iron sulfide compounds is very important because they are widespread in nature, such as sediments in a bay or lake. The detection of these sulfide compounds by previous methods is not effective because which can not detect the solid phase iron sulfide simultaneously with the acid volatile sulfide. Electrochemical methods of the analysis are a more attractive option because they are inexpensive, highly sensitive and reliable to long-time use and reproducibility. The electrochemical detection of acid volatile sulfide has been reported widely, using carbon, platinum, mercury and gold as working electrodes <sup>[66,67]</sup>. Nevertheless, the severe detection conditions can damage the electrode and cause fluctuating background currents <sup>[68]</sup>. Some research groups have reduced these problems by modifying the electrode, or using special electrochemical detection techniques such as pulsed electrochemical detection. Platinum-silver twin electrode can be used to eliminate this problem without any pretreatment of the electrode because of the stable surface morphologies. Thus, the twin electrode surface is relatively easy to be purged and reproduced.

In this study, we carry out the electrooxidation and voltammetry with a platinum-silver twin electrode in suspension to produce the electrochemically active species and estimate the potential of ferrous ion peak and sulfide ion peak. The characteristic with the twin electrode is that the domain of electrode reaction is limited in the space between two electrodes. Therefore, we can measure the concentration of the species which is produced by electrode reaction in the limited domain even if it is heterogeneous system such as suspension. For the suspension

samples, we can analyze the species produced from the electrolysis of iron sulfide after the electrode reaction with the twin electrode by the linear sweep voltammetry. In Chapter 3 and Chapter 4, we will report about the electrochemical technique by which we can directly determine iron monosulfide and iron disulfide quantitatively in the suspension samples by the detection of ferrous ion and sulfide ion with the twin electrode.

This research presents a re-optimised methodology for the determination of solid phase iron sulfide, where the electrochemically active species is generated from the electrolytic oxidation of iron sulfide in the suspension, and the linear sweep voltammetric determination of these species is readily performed using a newly developed platinum-silver twin-electrode. This kind of electrode has experimental advantages such as more stable and repeatable than film electrode, resulting in a continuous measurement of objective components on the electrode surface, which reduces the cost. Additionally, the twin electrode has a limited domain, which makes the sample electrolysis and the simultaneous determination possible on two electrode surface in the same electroanalysis procedure. This feature increases their applicability. When this methodology was applied to the determination of iron sulfide in mixture suspension samples, the concentrations of ferrous ion and sulfide ion generated from mixture suspension samples were determined and calculated to quantify the contents of iron monosulfide and iron disulfide.

In this chapter, we report on the electrolytic oxidation performance and the advantages of the Pt-Ag twin electrode for the quantificational analysis of FeS and FeS<sub>2</sub> in the suspension. In addition, the optimal instrumental parameters of the twin electrode were discussed and finally decided to perform our electroanalysis procedure. This procedure includes three features described as follows:

1. We perform electrolytic oxidation of FeS and FeS<sub>2</sub> in the suspension on Pt electrode with the twin electrode at 1.3V (vs. SCE) for a given time, converting insoluble iron sulfide into soluble ferric ion and elemental sulfur.
2. The dependencies of the measured concentrations of ferrous ion and silver sulfide on the electrolytic oxidation conditions, such as oxidation potential and time,

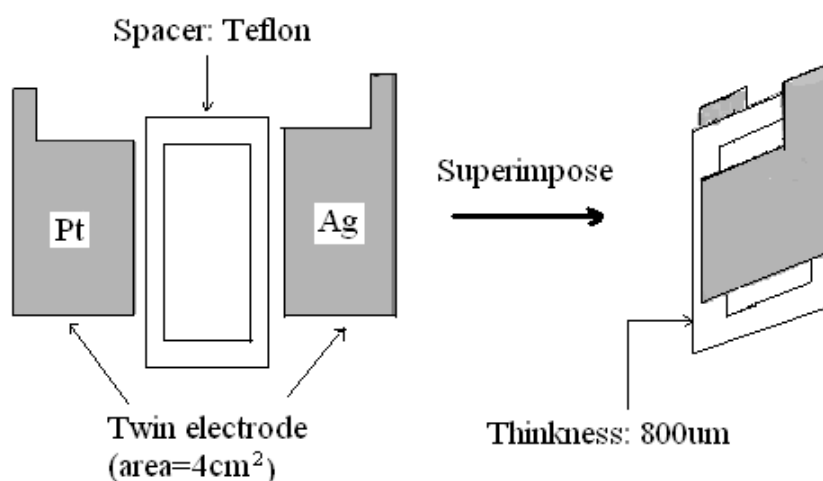
were studied by the subsequent electroanalysis procedure, and the optimal electrooxidation conditions were decided.

3. Based on the preset condition, the optimal instrumental parameters of the twin electrode were discussed, such as electrode area and Teflon thickness, and finally decided to perform our electroanalysis procedure.

## 2.2 Experimental Section

### 2.2.1 Twin Electrode

The platinum and silver plates were purchased from Nilaco Co., cut as shown in Figure 2.1 and separated by a Teflon spacer with thickness of 800 $\mu\text{m}$  to compose a twin electrode. The twin electrode has an effective area of 4 $\text{cm}^2$  and a clearance of 800 $\mu\text{m}$ . The twin electrode was assembled in a holder. We immersed the whole electrode with the holder into the solution and suspension samples to perform the experiments of electrolysis and voltammetry.



**Figure 2.1** Schematic of Pt-Ag twin electrode. The twin electrode is assembled by superposition of a Pt plate, a Teflon spacer and a Ag plate in a cell holder.



### ***2.2.2 Reagents and Sample Preparation***

All the reagents, including NaCl, poly-vinylpyrrolidone (PVP) and iron monosulfide (FeS), except for iron disulfide (FeS<sub>2</sub>), were purchased from Nacalai Tesque, Inc. and used without further purification. Reagent FeS<sub>2</sub> was purchased from Kishida Chem. Inc.. Solutions and suspensions were prepared using deionized water by Milli-Q system (Millipore Corp.).

Suspension samples were made by uniformly dispersing FeS and FeS<sub>2</sub> powder into a disperse medium. The reagent of FeS has been crushed for 3 minutes before use; the disperse medium was made by dissolving 0.4M poly-vinylpyrrolidone (PVP) into 0.5M NaCl solution. Herein, PVP was used to achieve a viscosity sufficient of the disperse medium to prevent sedimentation of the dispersoids during the process of measurement.

### ***2.2.3 Equipments***

The twin electrode was used as working electrode for cyclic voltammetry and other electrochemical experiments, such as electrolysis and linear sweep voltammetry, which was composed of a Pt plate and a Ag plate purchased from Nilaco Co., with an effective area of 4cm<sup>2</sup> and a clearance of 800mm. A saturated calomel electrode (SCE) and a platinum wire were used as the reference and auxiliary electrodes, respectively. The electrolysis and voltammetric measurements were carried out in an ALS CH Instruments Electrochemical Analyzer Model 701C.

All potentials are quoted against to this SCE reference electrode. All experiments were conducted at room temperature (ca. 25°C).

### ***2.2.4 Electrooxidation Methodology***

In the iron sulfide suspensions, the electrooxidation experiment was performed with Pt electrode of the twin electrode at 1.3V (vs. SCE) for one minute to produce the dissolved ferric ion and elemental sulfur. The ferrous ion and sulfide ion were generated by reducing the ferric ion and elemental sulfur, and accumulated at potential of 0.3V for ferrous ion and -0.4V for silver sulfide. In carrying out the voltammetry for determination of ferrous ion and silver sulfide, the potentials of sweep step were scanned from 0.3V to 0.7V for ferrous ion and from -0.4V to -1.2V for silver sulfide. The dependencies of the concentrations of ferrous ion and silver sulfide on the oxidation potential and oxidation time were obtained using the 0.1 wt% of iron sulfide suspension samples.

Before each experiment, the samples were deoxygenated with bubbling argon for 15 min. The working electrode has been polished with 0.05 $\mu$ m alumina powder (BAS Co.) on a wet pad wetted with Milli-Q water, and purged by oxidation potential of 1.0V on Pt electrode and reduction potential of -1.2V on Ag electrode respectively in the 0.5 mol L<sup>-1</sup> NaCl aqueous solution before each electroanalysis process.

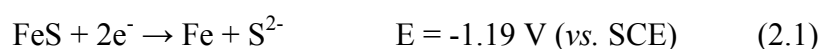
### ***2.2.5 Result Evaluations***

From the voltammograms of ferrous ion and sulfide ion, we can obtain the charge values of the peaks, by which we can evaluate the concentrations of ferrous ion and sulfide ion. For ferrous ion measurement, a diffusion process occurred on Pt electrode in the negative scan of LSV; whereas for sulfide ion measurement, a stripping process occurred on Ag electrode in the positive scan of LSV. Therefore, the Diffusion model for the charge calculation of half peak of ferrous ion and the Gauss model for the charge calculation of whole peak of sulfide ion were adopted to evaluate the concentrations of ferrous ion and sulfide ion in the iron sulfide suspension.

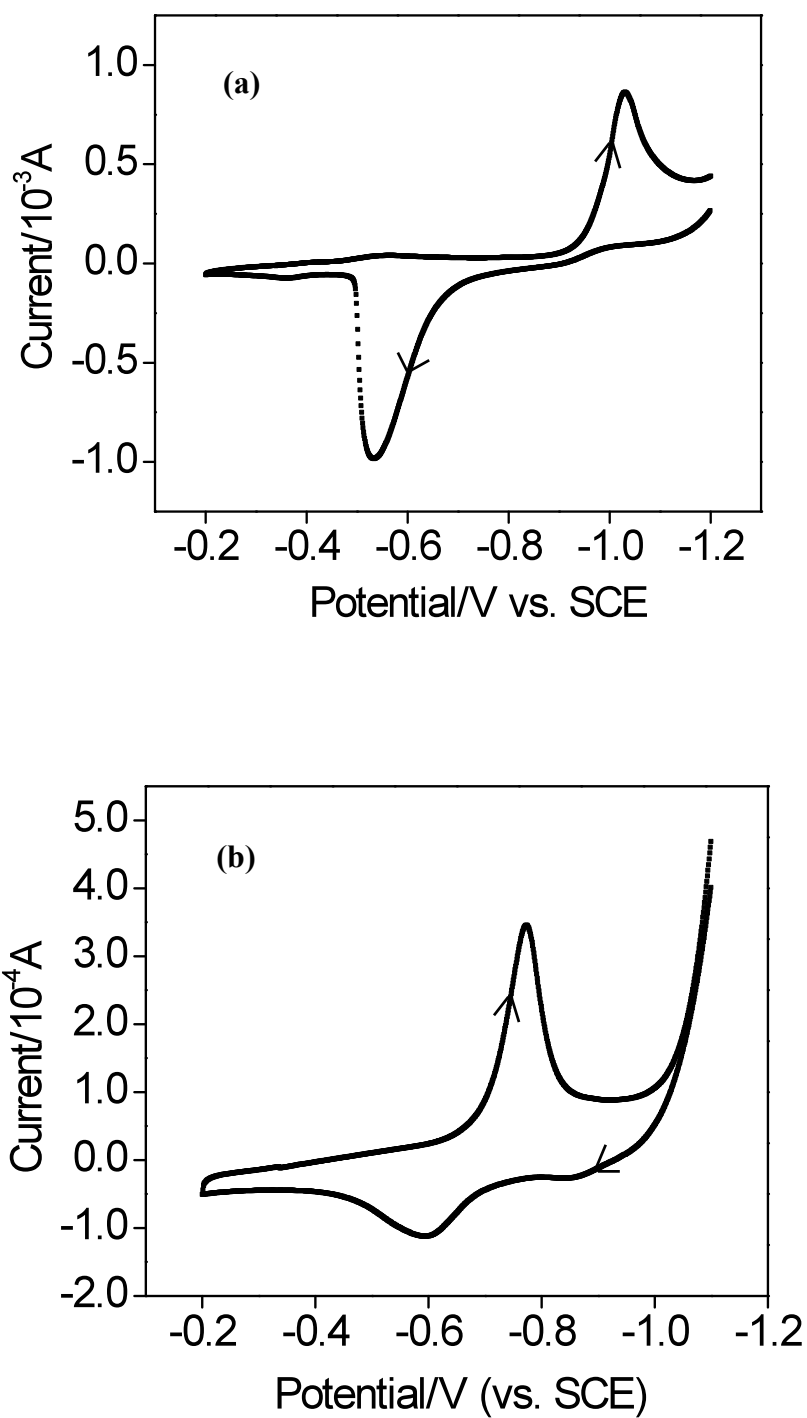
## **2.3 Results and Discussion**

### ***2.3.1 Mechanism for Generations of Ferric Ion and Elemental Sulfur from the Electrolytic Oxidation of Iron Sulfide in Suspension***

Since solid phase iron sulfide is little dissolved in water, it is difficult to electrolyze and determine it on the electrode surface directly. Huheey (1988) reported that solid phase FeS reacts at -0.95V versus the standard hydrogen electrode (SHE) via eqs 2.1:

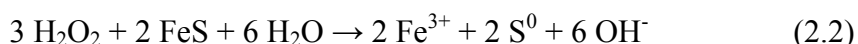


Correcting for the SCE, we calculate a potential of -1.19V for this reaction which is in a good agreement with the CV results of FeSO<sub>4</sub> and Na<sub>2</sub>S solutions. The Fe<sup>2+</sup> in FeS is reduced to Fe at Pt electrode, and sulfide ion is released to solution. A reduction peak for Fe is observed at ca. -1.0V (vs. SCE) during the positive scanning in a CV procedure (see Figure 2.2a). The S<sup>2-</sup> ion generated from FeS reacts with Ag electrode to form Ag<sub>2</sub>S on the electrode surface. During the positive scanning, Ag<sub>2</sub>S is reduced to Ag and sulfide ion is released to solution, showing a reduction peak at -0.8V (vs. SCE) in another subsequent CV procedure (see Figure 2.2b). The detected limitation is the 0.05wt% of iron sulfide. Although the determination of iron sulfide by reduction electrolysis failed in the low concentration suspension samples, it revealed some details of iron sulfide reaction principle at the twin electrode.



**Figure 2.2** Cyclic voltammograms of 0.1wt% FeS in the suspension at 25°C after electrolytic reduction at -1.2V (vs. SCE) for one minute on Pt electrode. (a) iron; (b) silver sulfide.

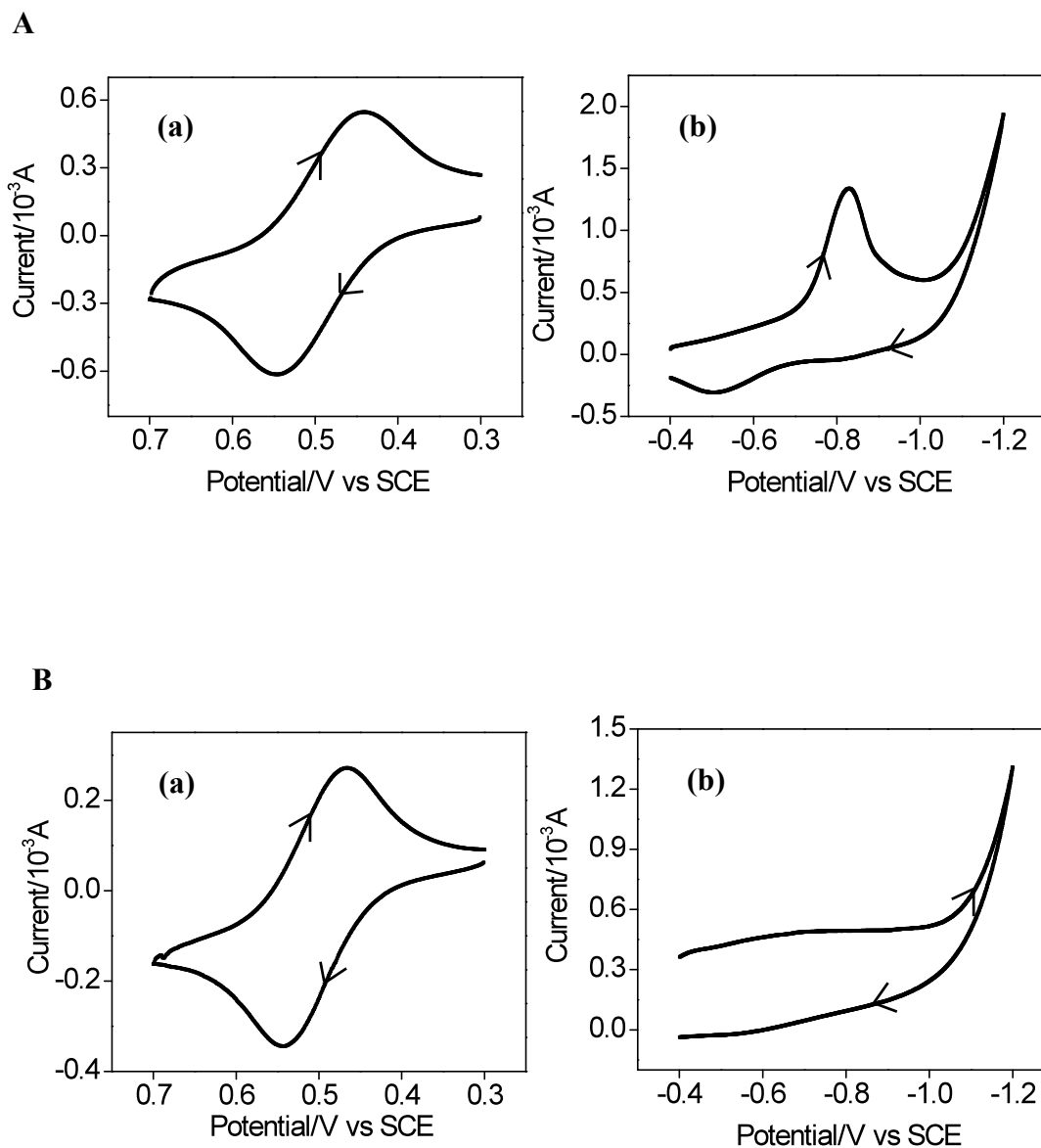
The oxidation electrolysis can also be used to produce the electrochemically active species from the solid phase iron sulfide in suspension because iron sulfide can be easily oxidized by the hydrogen peroxide which is generated from the oxidation of water on the Pt electrode. This process can be described as eqs 2.2 and 2.3.



Redox potential is 1.49V (vs. SCE) for the generation of hydrogen peroxide from oxidation of water:



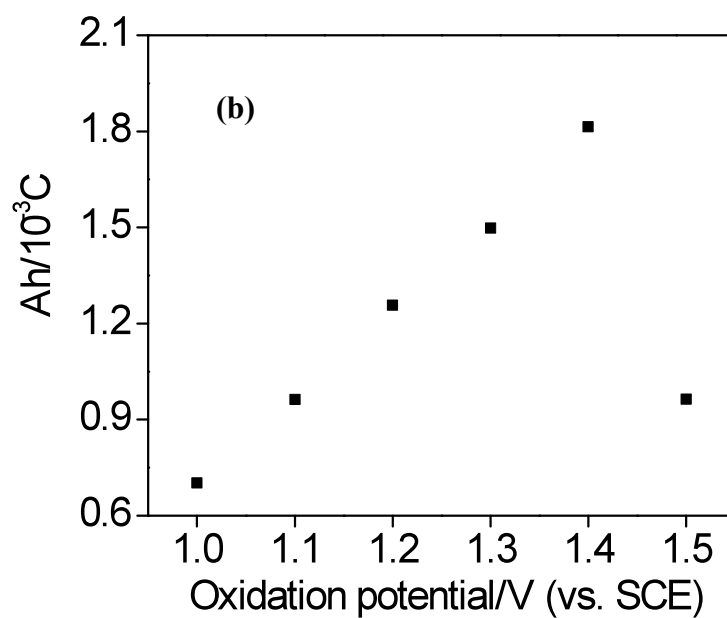
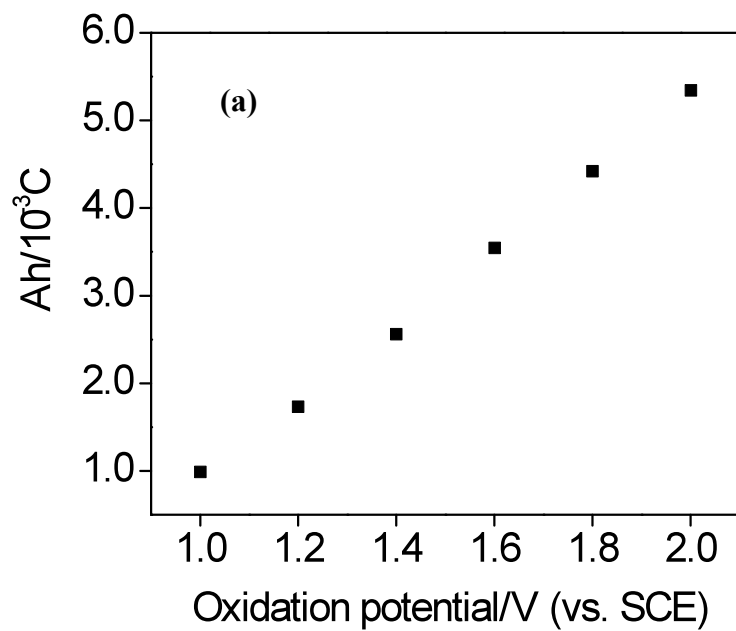
At pH= 7, the redox potential in eqs 2.3 becomes 1.08V. Therefore when we apply the electrolytic oxidation to suspension samples containing 0.1wt% iron sulfide with twin electrode for one minute, the soluble ferric ion and elemental sulfur are generated and dissolved into the suspension, so that we can measure the concentrations of ferrous ion and sulfide ion which are produced by reducing the ferric ion and elemental sulfur (see Figure 2.3). Moreover, the influence of oxidation conditions, such as oxidation potential and oxidation time on the determination of ferrous ion and silver sulfide was studied before the calibration of this method.



**Figure 2.3** Cyclic voltammograms of 0.1wt% iron sulfide samples in suspension at 25°C after electrolytic oxidation at 1.3V for one minute. (A) FeS: (a) ferrous ion, (b) silver sulfide; (B) FeS<sub>2</sub>: (a) ferrous ion, (b) silver sulfide.

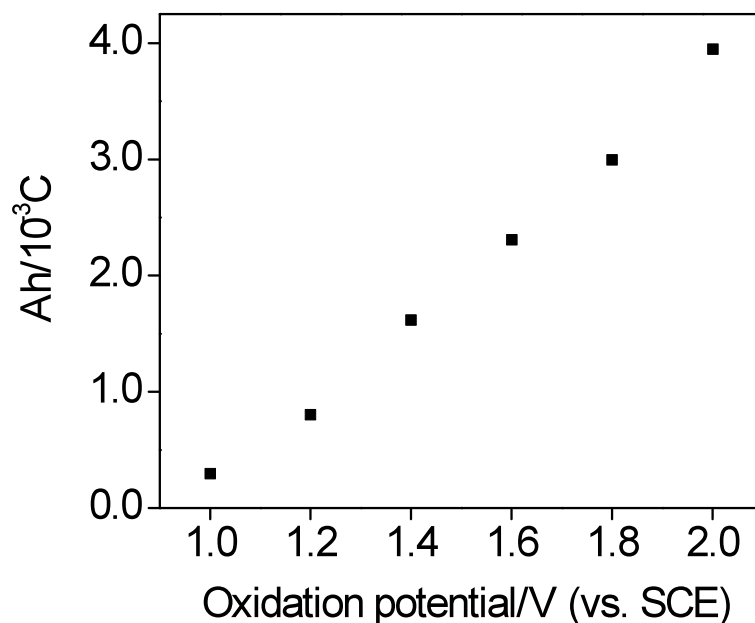
### ***2.3.2 Dependencies of Generations of Ferrous Ion and Silver Sulfide on the Oxidation Potential***

Although the ferrous ion and silver sulfide are not the direct product from the electrolytic oxidation of iron sulfide, the measured concentrations of ferrous ion and silver sulfide may depend on the oxidation conditions because the species are generated from the ferric ion and elemental sulfur. The dependencies of generations of ferrous ion and silver sulfide on the oxidation potential are shown in Figure 2.4 and Figure 2.5. We found that the charge of ferrous ion peak increased with the oxidation potential from 1.0V to 2.0V, and that the charge of silver sulfide peak increased with the oxidation potential from 1.0V to 1.4V. This is due to the fact that at the potential of the vicinity of 1V, hydrogen peroxide begins to form on the Pt electrode, so that iron sulfide is oxidized and the generated ferric ion and elemental sulfur dissolve into the suspension. With the increasing of oxidation potential, hydrogen peroxide increases, so that concentrations of ferric ion and elemental sulfur increase. The ferrous ion and sulfide ion are generated from the reduction of ferric ion and elemental sulfur by the subsequent accumulation process. Stable measured values can not be provided at potential higher than 2V for ferrous ion owing to the generation of oxygen gas between the twin electrode, and at potential higher than 1.4V for silver sulfide due to the deposition of silver chloride on Ag electrode surface.



**Figure 2.4** Dependencies of generations of ferrous ion and silver sulfide on the oxidation potential in FeS suspensions. (a) ferrous ion; (b) silver sulfide.

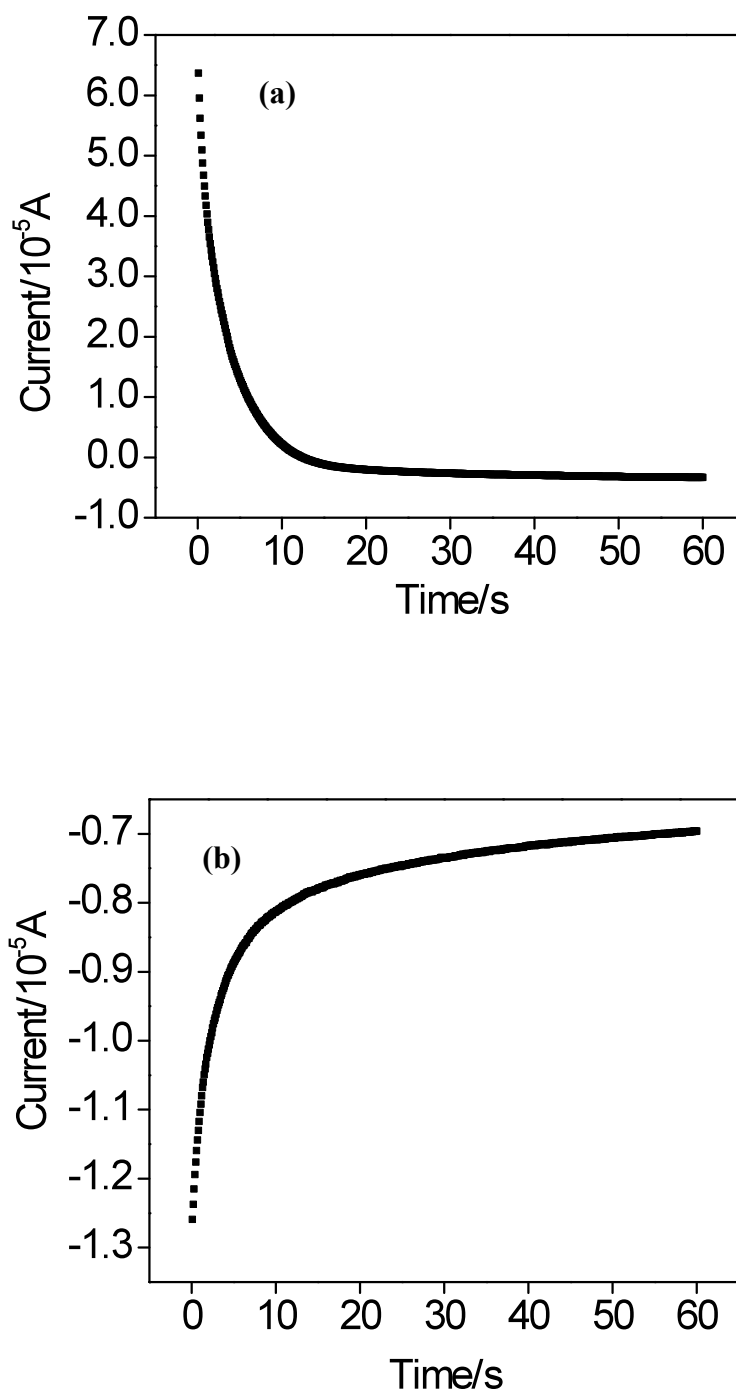




**Figure 2.5** Dependency of generation of ferrous ion on the oxidation potential in FeS<sub>2</sub> suspensions.

We can observe the evidence of silver chloride deposition on Ag electrode surface from the amperomogram of the silver sulfide deposition process, as shown in Figure 2.6. The chloride ion existing in the electrolyte solution can be oxidized by the hydrogen peroxide to form chlorine gas at oxidation potential higher than 1.3V. The chlorine gas is dissolved into water and produced hydrochloric acid (HCl) and hypochlorous acid (HClO). The Ag electrode is easy to be oxidized by hypochlorous acid, and the generated silver chloride is deposited on the Ag electrode surface. During the deposition process of silver sulfide on Ag electrode at -0.4V, a reduction current is observed by reducing silver chloride to silver and chloride ion, instead of oxidation current by oxidation of silver. However, in the case of the oxidation potential lower than 1.3V, the deposition process at -0.4V presents an oxidation current because the silver is oxidized to silver sulfide with the existence of sulfide ion, without the influence of silver chloride. Therefore, the potential is decided at 1.3V (vs.

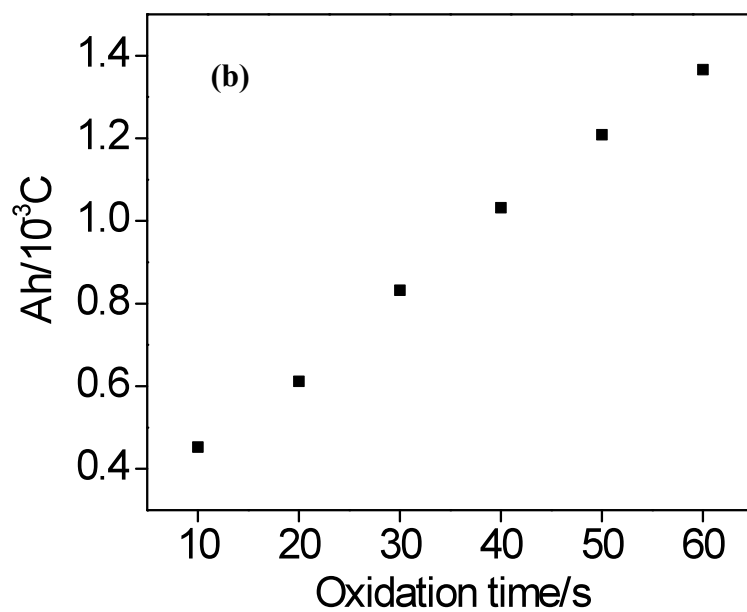
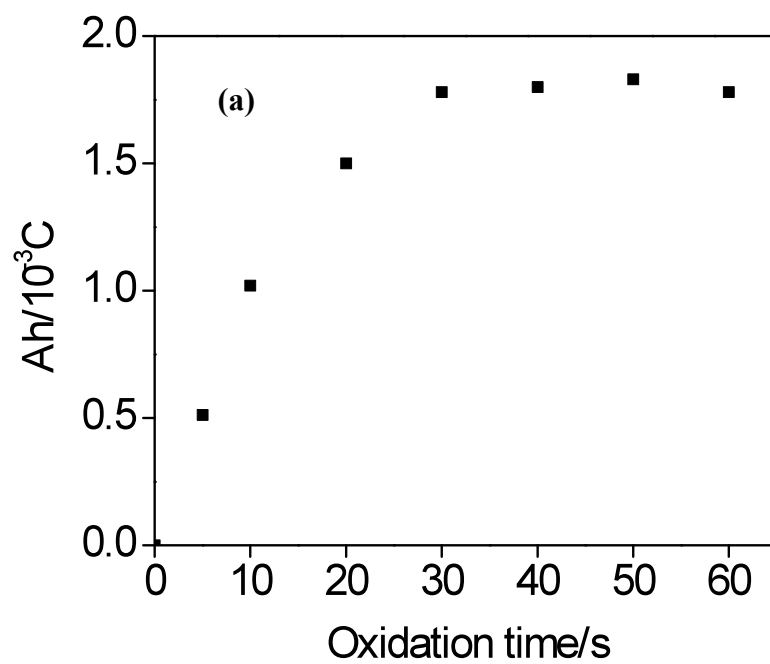
SCE) to perform the electrolytic oxidation of iron sulfide in the suspension.



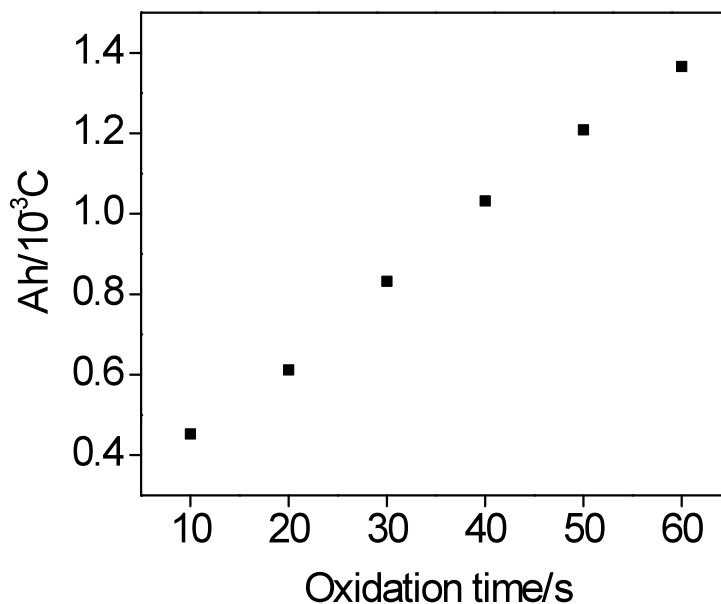
**Figure 2.6** Amperommmograms of silver sulfide deposition in the 0.1wt% FeS suspensions after electrolytic oxidation for one minute. Oxidation potential: (a) >1.3V (vs. SCE); (b) <1.3V (vs. SCE).

### ***2.3.3 Dependencies of Generations of Ferrous Ion and Silver Sulfide on the Oxidation Time***

The hydrogen peroxide is produced by the electrolytic oxidation of water at potential of 1.3V (vs. SCE) so that its amount is positively correlative to the electrolytic oxidation time. Since the amounts of ferric ion and elemental sulfur produced are proportional to the amount of hydrogen peroxide, the measured concentrations of ferrous ion and silver sulfide which originate from the reduction of ferric ion and elemental sulfur are in positive correlation to the electrolytic oxidation time. The charges of ferrous ion peak and silver sulfide peak increase with electrolytic oxidation time and reach saturation within 60 s at oxidation potential of 1.3V as shown in Figure 2.7 and Figure 2.8. The oxidation rate associates with the parameter of electrode area  $A$ , distance between the twin electrode  $L$ , as well as the potential of the electrolytic oxidation. For a given condition where the three parameters have been preset, the amount of hydrogen peroxide produced should be constant. In this case, the oxidation rate is only dependent on the amount of iron sulfide in the suspension during a given time of electrolytic oxidation.



**Figure 2.7** Dependencies of generations of ferrous ion and silver sulfide on oxidation time with oxidation potential at 1.3V (vs. SCE) in FeS suspensions. (a) ferrous ion; (b) silver sulfide.



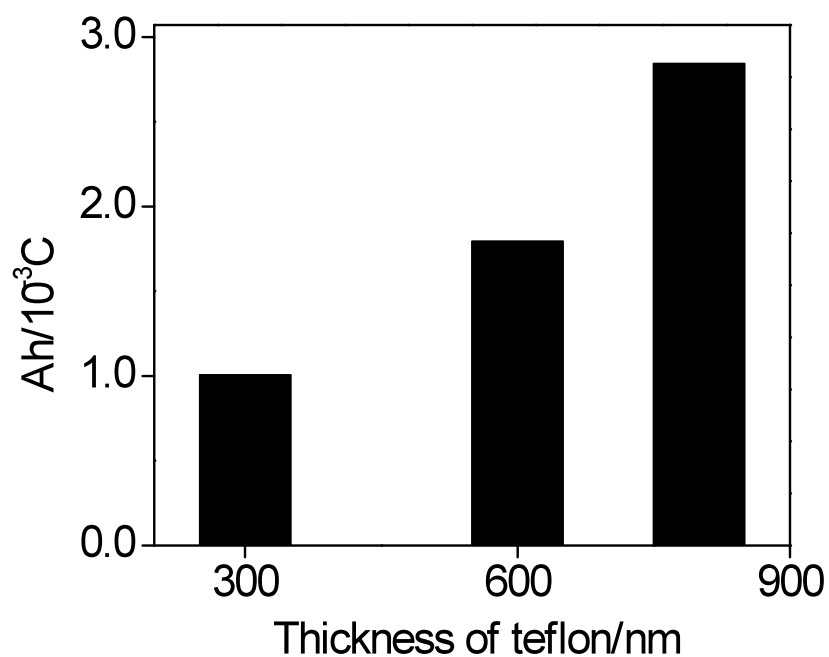
**Figure 2.8** Dependency of generation of ferrous ion on oxidation time with oxidation potential at 1.3V (vs. SCE) in FeS<sub>2</sub> suspensions.

### ***2.3.4 Effect of Teflon Spacer Thickness on the Determination of Silver Sulfide in the Suspension***

We performed electrolytic oxidation with twin electrode, so that the dissolved ferric ion and elemental sulfur were confined to an interval space between the two working electrodes of twin electrode without diffusion to the outside. In this case, the concentrations of ferric ion and elemental sulfur do not vary with time during the process of measurement, and we can measure the concentrations of ferrous ion and sulfide ion by linear sweep voltammetry with the twin electrode.

Between the two electrodes, Teflon spacer was used to make a reaction space to carry out electrolysis and voltammetry. When hydrogen peroxide was generated from the electrolysis of water on Pt electrode surface, the chloride ion existing in the suspension will be oxidized to chlorine gas by hydrogen peroxide. The chlorine gas is very easy to oxidize silver and the generated silver chloride covers the Ag electrode

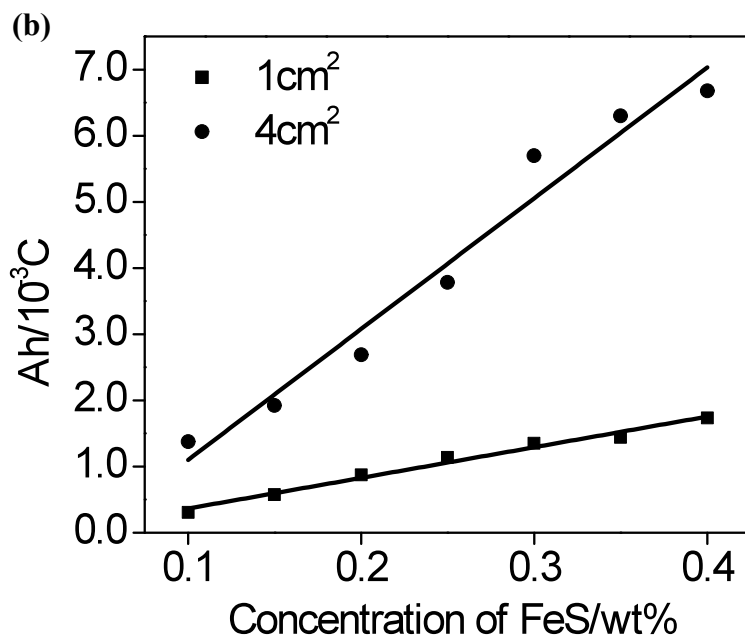
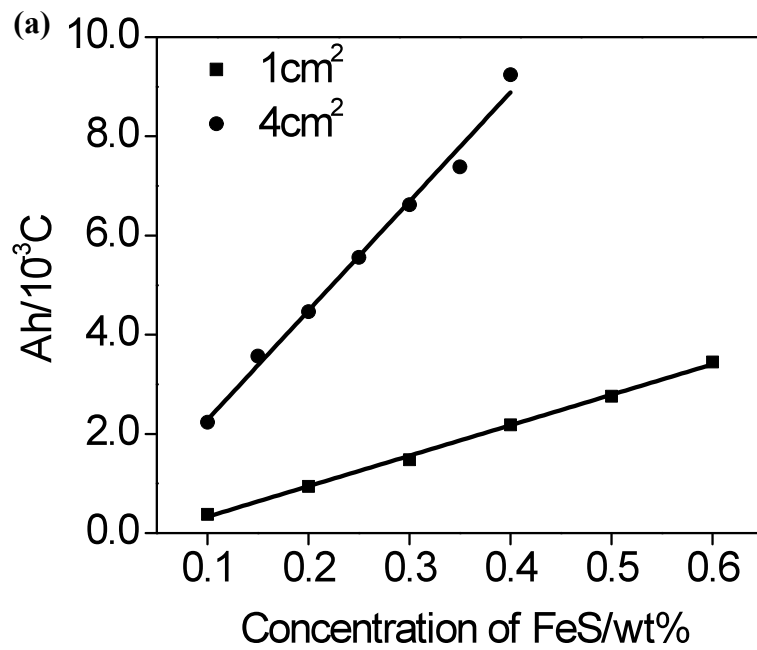
surface, so that the electrode becomes partially inactive. The Teflon spacer with appropriate thickness will eliminate the generation of silver chloride by increasing the distance between the twin electrodes. Therefore, according to the result as showed in Figure 2.9, the thickness of Teflon spacer is decided at 800 $\mu$ m to perform the electrolytic oxidation of iron sulfide.



**Figure 2.9** Effect of the thickness of Teflon spacer on the determination of silver sulfide in the iron monosulfide suspensions.

### ***2.3.5 Effect of Surface Area of Twin Electrode on the Determination of Ferrous Ion and Silver Sulfide in Suspension***

The oxidation rate associates with the parameter of electrode area  $A$ , distance between the twin electrode  $L$ , as well as the condition of the electrolytic oxidation. At a given condition where the parameters of distance and oxidation have been preset, the amount of hydrogen peroxide produced during the electrolytic oxidation process is dependent on the electrode area during the electrolytic oxidation process. Therefore, the ferric ion and elemental sulfur, generated from the oxidation of iron sulfide by hydrogen peroxide, are also related to the electrode area. We used two kinds of electrode with surface area of  $1\text{cm}^2$  and  $4\text{cm}^2$  to investigate the influence of electrode area on the determination of ferrous ion and sulfide ion by the same electroanalysis procedure, and found that the larger electrode area will increase the measured charge value of the peaks and decrease the detection limitation of the method. Based on this result, we apply the twin electrode with surface area of  $4\text{cm}^2$  to perform our electroanalysis procedure.



**Figure 2.10** Effect of the surface area of twin electrode on the determination of ferrous ion and sulfide ion in the FeS suspensions. (a) ferrous ion; (b) silver sulfide.



## 2.4 Conclusions

Because iron sulfide is slightly soluble in water, it is difficult to analyze and determine it directly by electrochemical method. However, after being electrolytically oxidized in twin electrode, slightly soluble iron sulfide can be transformed into soluble ferric ion and elemental sulfur. This makes it possible to determine the iron sulfide using voltammetry method. We investigated the mechanism of the generations of ferric ion and elemental sulfur from the electrooxidation in the iron sulfide suspension with the twin electrode. According to cyclic voltammetry, we found that the ferrous ion and sulfide ion, which is generated by reducing the ferric ion and elemental sulfur, can be determined after electrolytic oxidation with our Pt-Ag twin electrode in the iron sulfide suspensions.

Moreover, the influence of the electrolytic oxidation conditions such as oxidation potential and oxidation time upon the determination of ferrous ion and silver sulfide in the iron sulfide suspensions was studied, and found that the electrooxidation at the potential of 1.3V (vs. SCE) for 1 min was suitable for the experiment. The effect of the thickness of Teflon spacer on the measurement of silver sulfide was also investigated using three kinds of spacer with different thickness and we decided it at 800 $\mu$ m to perform electrolysis and voltammetry. Furthermore, two kinds of twin electrode with the surface area of 1cm<sup>2</sup> and 4cm<sup>2</sup> were applied in the determination of iron sulfide suspension samples, and we found that the bigger electrode area increase the measured charge value and the detection limitation decrease accordingly.

In conclusion, we can determine the concentrations of ferrous ion and sulfide ion produced from iron sulfide after electrolytic oxidation in the suspension samples by our proposed electrochemical method with Pt-Ag twin-electrode, and will report the optimization of the determination conditions and the calibrations of the method in the next two chapters.

## CHAPTER 3

### DETERMINATION OF CONTENTS OF IRON MONOSULFIDE AND IRON DISULFIDE BY ANALYSIS OF FERROUS ION WITH TWIN ELECTRODE IN SUSPENSIONS

#### 3.1 Introduction

For the regular observation of AVS analysis, on-site measurements play an important role by dispensing with sample handling and storage. An electrochemical analytical method is a simple, accurate and effective technique in the on-site measurements and has been used as a substituted methodology of the on-site environmental analysis in sediments.

Using the voltammetry, we can analyze the behavior of the electrochemically active species and achieve the qualitative and quantitative analysis of the measured components. For example, cyclic voltammetry is applied to study the characters and mechanism of electrode reaction, and the dynamic parameters of electrode process. Square wave voltammetry and stripping voltammetry have high sensitivity for the determination of concentration of the species <sup>[69-71]</sup>. Especially, the stripping voltammetry has a unique technique which can concentrate the species on the electrode by electrode reaction and then analyze them. Therefore, in the voltammetry, we can analyze the species after electrode reaction even if we cannot directly analyze them in potentiometry.

In this study, we carried out the voltammetry in the aqueous solution and suspension with electrochemically active species such as  $\text{Fe}^{2+}$  and  $\text{S}^{2-}$  to estimate the potential of ferrous ion peak and sulfide ion peak using a platinum-silver twin-electrode. Electrochemistry with the twin electrode belongs to the field of thin-layer electrochemistry. The thin-layer electrochemistry was first studied in the

early 1960's, and potential step methods and potential sweep methods were studied extensively [72-74]. Therefore, theoretically the voltammetry with the twin electrode can estimate the concentrations of ferrous ion and sulfide ion in the aqueous solution. On the basis of this principle, we assume that the concentrations of ferrous ion and sulfide ion in the suspension can be also determined using the linear sweep voltammetry with the same Pt-Ag twin electrode.

The common methods for the determination of AVS are colorimetry [75,76], gravimetry, ion-selective electrode or photoionization detection [77], in which the first step of each method involves converting the sulfide in the sample to H<sub>2</sub>S by reaction with 1 or 3 mol L<sup>-1</sup> hydrochloric acid (HCl), purging the system with purified inert gas and trapping the evolved H<sub>2</sub>S in a suitable solution (purge-and-trap procedure). The first two methods are time consuming and complicated. The ion-selective electrode method is somewhat unreliable due to the problems in the electrode performance although simple to use, and the photoionization detection is expensive and inadequate for the samples with concentrations higher than 10 μmol g<sup>-1</sup> [77]. However, inorganic sulfur species can easily be determined by voltammetric methods using a mercury drop electrode, namely by linear sweep voltammetry (LSV) [78,79], cathodic stripping voltammetry (CSV) [80,81] or polarography [80]. Using cathodic stripping voltammetric methods nanomolar concentrations of sulfide species may be easily assessed. The reported procedures for the voltammetric determination of AVS involve the determination of sulfide, pre-collected in the sodium hydroxide trap solution, using polarography [80] or linear voltammetry at low scan rates, e.g. 50 mVs<sup>-1</sup> [78]. 10 An important drawback to these electroanalytical techniques is often attributed to the frequent necessity of using a hanging mercury drop electrode (HMDE), but its use has been limited to analytical procedures due to the hazardous effects of mercury. Having the main objective of avoiding the use of mercury in such analysis, several modifications of electrodes have been proposed [82]. Therefore, an alternative analytical approach for the sensitive and rapid determination of AVS is envisaged.

This work presents a re-optimised methodology for the determination of iron sulfide, where the electrochemically active species is generated from the electrolytic

oxidation of iron sulfide in suspension, and the linear sweep voltammetric determination of these species is readily performed using a new developed Pt-Ag twin electrode. This kind of electrode has experimental advantages such as more stability and repeatability than other thin-film electrodes, resulting in a continuous measurement of objective components on the electrode surface, which reduces the cost. Additionally, the twin electrode has a limited domain, which makes the sample electrolysis and the simultaneous determination possible on two electrode surface in the same electrochemical analysis procedure. This feature increases their applicability. When this methodology was applied to the determination of iron sulfide in mixture suspension samples, the charge amounts from ferrous ion and sulfide ion generated from mixture suspension samples were determined and the iron monosulfide content and iron disulfide content were calculated.

In this chapter, we will report about the electrochemical technique by which we can directly determine the contents of FeS and FeS<sub>2</sub> by the measured concentration of ferrous ion in the suspension samples with the twin electrode. This method includes three features described as follows:

1. With a Pt-Ag twin electrode, the ferrous ion in the iron sulfate solution can be detected by linear sweep voltammetry measurement.
2. We perform electrolytic oxidation of iron sulfide in the suspension with the Pt electrode at 1.3V (vs. SCE) for a given time, converting insoluble iron sulfide into soluble ferric ion and elemental sulfur.
3. On Pt electrode, the ferric ion is reduced to the ferrous ion with a reductive potential, which can be detected by linear sweep voltammetry. Based on the peak charge of voltammogram, the concentration of ferrous ion in the suspension can be calculated.

Finally, the contents of FeS and FeS<sub>2</sub> can be evaluated from the measured concentration of ferrous ion. We will also explore the feasibility of the proposed technique in the mixture suspension in Chapter 5.

## 3.2 Experimental Section

### 3.2.1 Reagents and Sample Preparation

All the reagents, including  $\text{FeSO}_4$ ,  $\text{Na}_2\text{S}$ ,  $\text{NaCl}$ , poly-vinylpyrrolidone (PVP) and iron monosulfide ( $\text{FeS}$ ), except for iron disulfide ( $\text{FeS}_2$ ), were purchased from Nacalai Tesque, Inc. and used without further purification. Reagent  $\text{FeS}_2$  was purchased from Kishida Chem. Inc.. Solutions were prepared using deionized water by Milli-Q system (Millipore Corp.).

For the preparation of  $\text{FeSO}_4$  solution, 0.5M  $\text{NaCl}$  aqueous solution was used as a supporting electrolyte solution. Suspension samples were made by uniformly dispersing  $\text{FeS}$  and  $\text{FeS}_2$  powder into a disperse medium. The reagent of  $\text{FeS}$  has been crushed for 3 minutes before use; the disperse medium consisted of 0.5 mol  $\text{L}^{-1}$  sodium chloride ( $\text{NaCl}$ ) and 0.4 mol  $\text{L}^{-1}$  poly-vinylpyrrolidone (PVP) in aqueous solution. Standard suspension samples of ferrous ion used for quality assurance and calibration were prepared by adding  $\text{FeS}$  or  $\text{FeS}_2$  in the concentration interval of 0.01wt% to 0.4wt% to the disperse medium respectively, using the analytical-grade reagents for all chemicals.

### 3.2.2 Apparatus

A conventional electrochemical cell was used containing a platinum-silver (Pt-Ag) twin-electrode as the working electrode, a reference electrode of saturated calomel electrode (SCE) and a platinum wire ring as an auxiliary electrode. The Pt-Ag twin-electrode was polished with alumina (0.3  $\mu\text{m}$ ), washed with water, and purged by oxidation potential of 1.0V on Pt electrode and reduction potential of -1.2V on Ag electrode respectively in the 0.5 mol  $\text{L}^{-1}$   $\text{NaCl}$  aqueous solution before each

electroanalysis process. The electrolysis and voltammetric measurements were carried out in an ALS CH Instruments Electrochemical Analyzer Model 701C.

All potentials are quoted against this SCE reference electrode. All experiments were conducted at room temperature (ca. 25°C).

### ***3.2.3 Electroanalysis Procedures***

The analytical methodology for releasing ferric ion and elemental sulfur from the electrolysis of FeS and FeS<sub>2</sub> was the following: The electrolytic oxidation was applied at 1.3V for 1 min on the Pt electrode in the FeS and FeS<sub>2</sub> suspensions which was previously deaerated with argon gas for 15 min, to generate soluble ferric ion and elemental sulfur. We performed electrolytic oxidation with twin electrode, so that the dissolved ferric ion and elemental sulfur were confined to an interval space between two working electrodes without diffusion to outside and variety with time during the process of measurement.

In this case, the ferrous ion were formed by subsequent electrolytic reduction of ferric ion, and measured by linear sweep voltammetry on Pt electrode. The accumulation step lasted 120 s at potential of 0.3V for ferrous ion accumulation. After a 2 s quiescent time, the sweeping step was performed from 0.3 to 0.7V for ferrous ion analysis. The scan rate was 10mV s<sup>-1</sup>. A current-potential curve can be obtained in linear sweep voltammogram. We can evaluate the ferrous ion concentration which is calculated from the charge amount of the curve and proportional to the measured charge amount. Calibrations were carried out with FeS and FeS<sub>2</sub> standardized suspensions. Finally, the contents of FeS and FeS<sub>2</sub> can be evaluated from the measured concentrations of ferrous ion by the calibration curves.

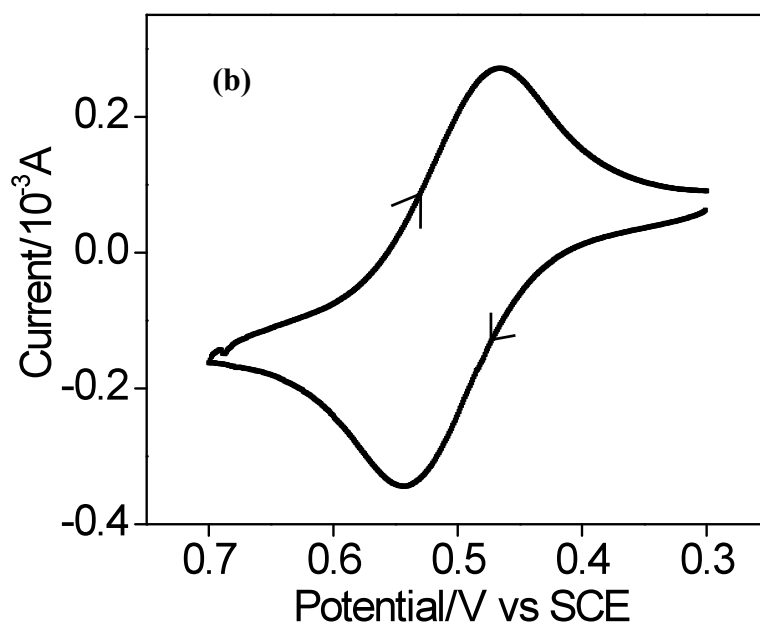
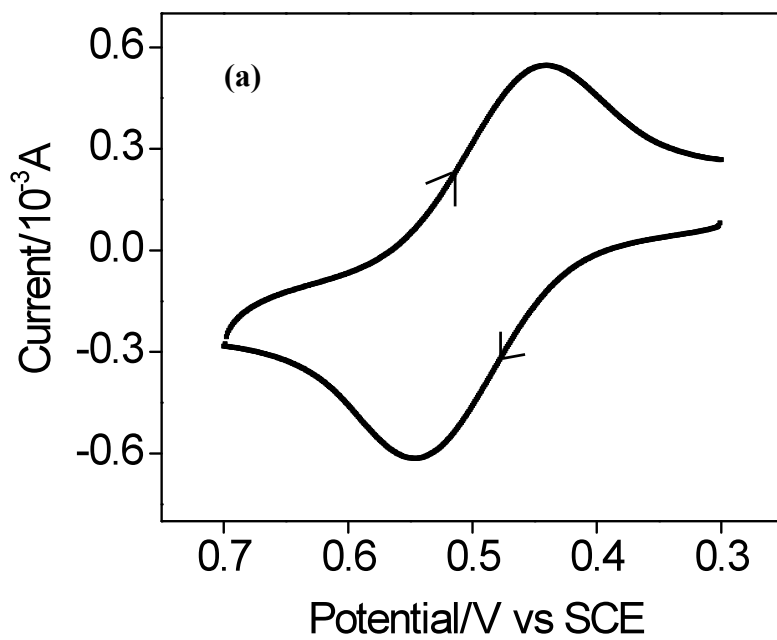
In the linear sweep voltammetric experiments using FeS and FeS<sub>2</sub> standardized suspensions (concentration of 0.1wt%), linear sweep scanning was also used with an accumulation time varying from 0 to 120 s at potential of 0.3V for ferrous ion accumulation and scan rates from 10 to 500mV s<sup>-1</sup>.

When 70.0 mL of the suspension sample was transferred to the voltammetric cell and analyzed using the linear sweep voltammetric techniques, the voltammograms were obtained.

### **3.3 Results and Discussion**

#### ***3.3.1 Identification of Ferrous Ion Peak Generated from Iron Sulfide in Suspension***

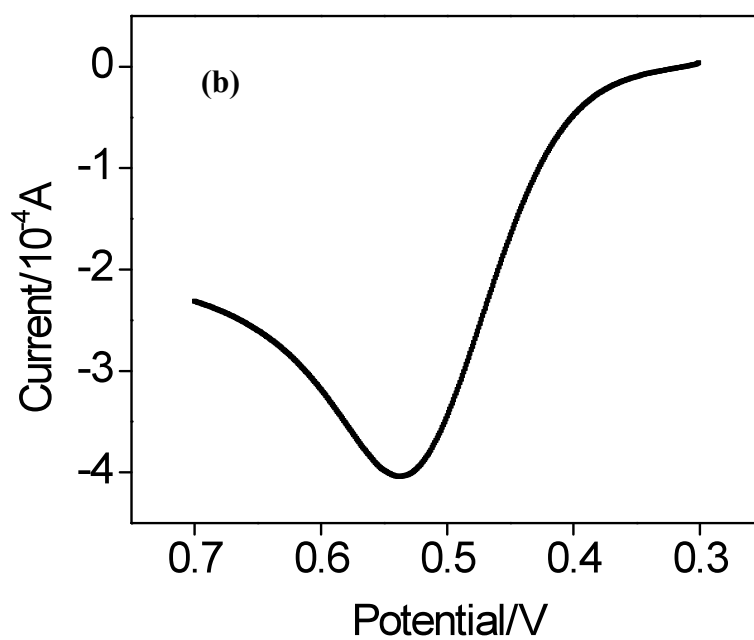
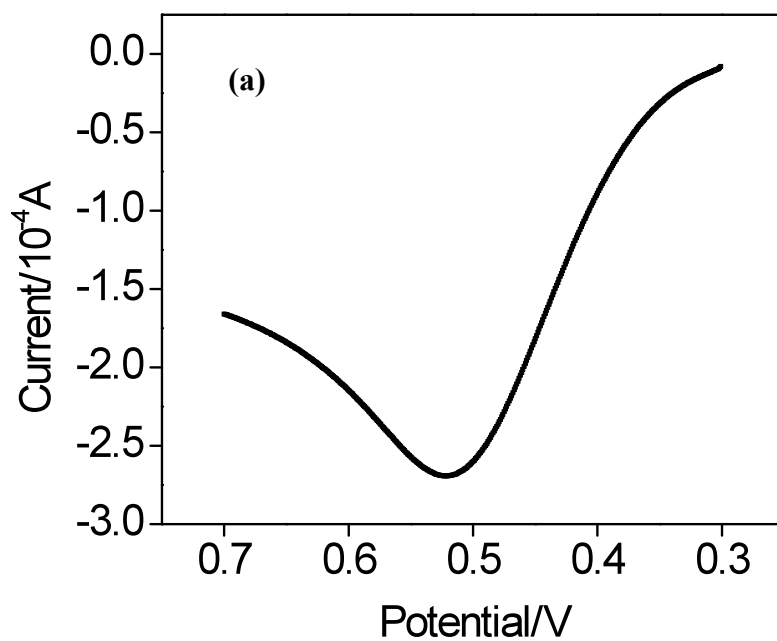
The importance of sulfide minerals as metal-binding components in anoxic sediments has been elucidated recently. Usually iron sulfide is the main component of sulfide minerals as reductive pollutant due to the existence of ferrous ion. It will be useful to investigate the extent of sulfide pollution if the iron sulfide can be analyzed electrochemically. We applied our Pt-Ag twin electrode into iron sulfide suspension containing 0.5M NaCl aqueous solution and 0.4M PVP disperse medium to perform a cyclic voltammetry. The experimental results are shown in Figure 3.1. The concentration of electrochemically active species in the suspension is so low that the distinct trace can not be observed by the cyclic voltammetry without pretreatment. However, we observed a well-defined oxidation wave from the cyclic voltammetry after applying the oxidation potential of 1.3V (vs. SCE) to the Pt working electrode for one minute.



**Figure 3.1** Cyclic voltammograms of ferrous ion peak in 0.1wt% iron sulfide suspension samples after electrolytic oxidation at 1.3V for one minute at 25°C. (a) FeS; (b) FeS<sub>2</sub>.



To confirm the wave of this species, the following experiments were carried out. We performed a similar cyclic voltammetry in the iron sulfate of 0.5M NaCl aqueous solution as in the suspension sample with the same twin electrode. We observed the potential response of ferrous ion from the iron sulfate solution (see Figure 3.2a) same as that in the iron monosulfide suspension (see Figure 3.2b). The peak consists with that in the voltammogram of ferrous ion, suggesting that the ferrous ion may originate from ferric ion, which is generated from the electrolytic oxidation of iron sulfide in the suspension, and can be determined in the subsequent electroanalysis procedure. This result indicates that the proposed electrochemical method can be applied to determine the iron sulfide in the suspension by the measurement of ferrous ion concentration.



**Figure 3.2** Linear sweep voltammograms of ferrous ion peak in different samples at 25°C.  
(a) iron sulfate solution; (b) iron monosulfide suspension.

### ***3.3.2 The Mechanism of Ferrous Ion Analysis in Suspension by Linear Sweep Voltammetry with Twin Electrode***

Iron sulfide can be transformed into the dissolved ferric ion and elemental sulfur after electrolytic oxidation in the suspension. We performed electrolytic oxidation with twin electrode, so that the dissolved ferric ion and elemental sulfur were confined to an interval space between the two working electrodes without diffusion to outside. In this case, the concentrations of ferric ion and elemental sulfur do not vary with time during the process of measurement, and we can measure the concentrations of ferrous ion and sulfide ion by linear sweep voltammetry with the twin electrode. The following shows an example of ferrous ion measurement.

We disperse the crushed FeS in a 0.5M NaCl aqueous solution containing 0.4M polyvinylpyrrolidone (PVP) to prepare the suspension sample of 0.1wt% FeS. The twin electrode is placed into the suspension at 25°C, and is applied the oxidation potential of 1.3V (*vs.* SCE) for one minute. After electrolytic oxidation, the ferric ion is generated and dissolved into the suspension. We apply a relative reduction potential of 0.3V to reduce the generated ferric ion to ferrous ion which is measured by the linear sweep voltammetry with the twin electrode. On the Pt electrode, during the negative sweep, a well-defined oxidation wave of ferrous ion was observed at ca. 0.5V *vs.* SCE (see Figure 3.2b). The analysis of this figure shows that the ferrous ion is oxidized to ferric ion in the voltammetric process by the transfer of one electron, which generates a measurable current.

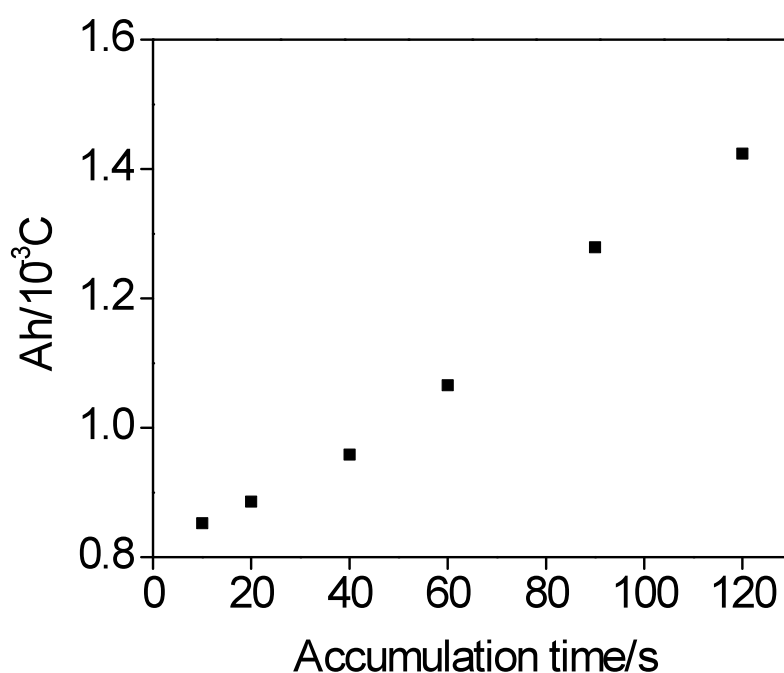
The trace of ferrous ion peak is detected by linear sweep voltammetry with the twin electrode. A current-potential curve can be obtained in linear sweep voltammogram. Based on the charge of the curve, we can determine the ferrous ion concentration by calculating from the charge value.

### ***3.3.3 Optimization of the linear sweep voltammograms for ferrous ion***

## *analysis*

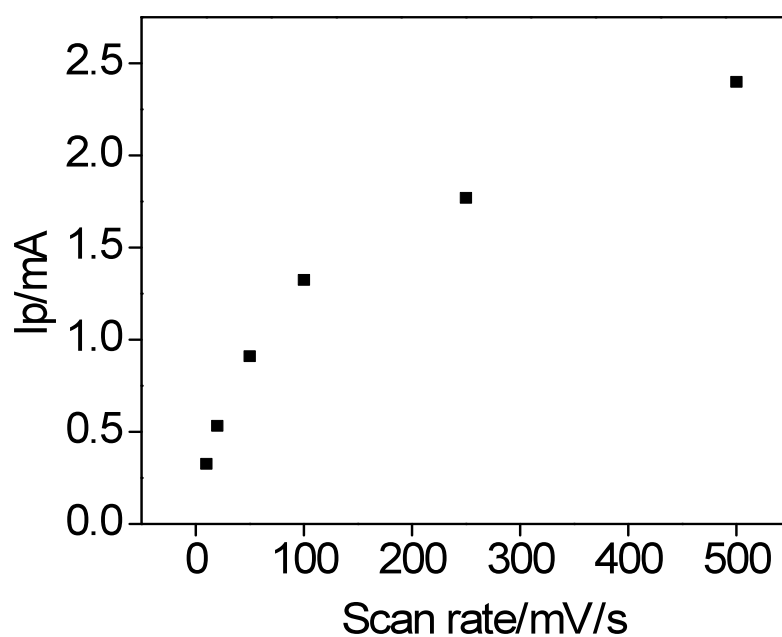
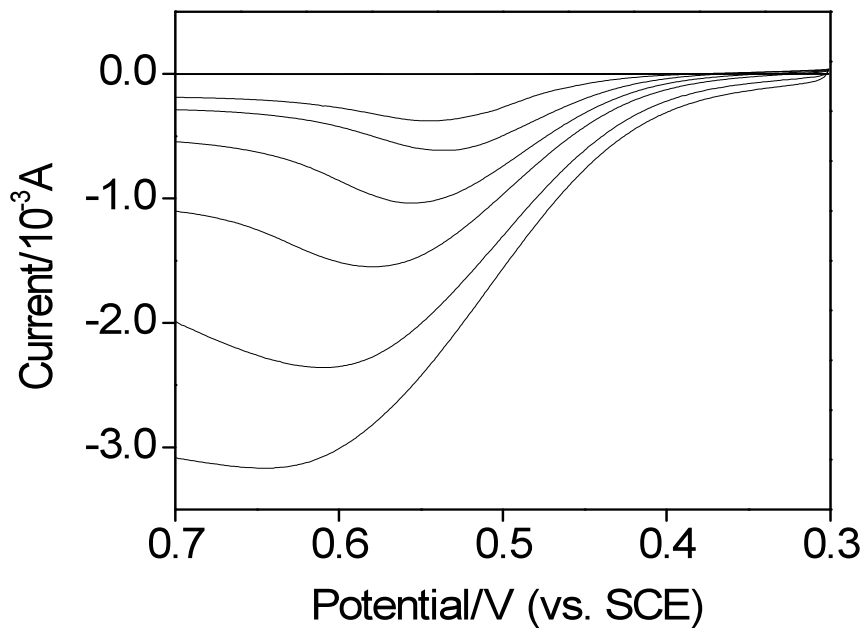
Before application of the voltammetric measurement in ferrous ion analysis, we evaluated the effect of the accumulation time and the scan rate in the linear sweep voltammograms of ferrous ion in the FeS suspensions.

The charge of ferrous ion peak depended linearly on the accumulation time, within the interval 0–120 s (slope =  $0.0054 \text{ mC s}^{-1}$ ;  $r=0.9887$ ;  $N=6$ ), as shown in Figure 3.3. The linear dependence indicates that the charge value is not saturated on electrode surface at accumulation time less than 120 sec. Therefore, within the concentration range 0.01–0.4wt% of iron sulfide, accumulation time of 120 sec for ferrous ion is suggested.



**Figure 3.3** Dependency of generation of ferrous ion on accumulation time with accumulation potential at 0.3V in 0.1wt% FeS suspension samples.

Another important instrumental parameter in linear sweep voltammetry is the scan rate. Figure 3.4 shows the linear sweep voltammograms of ferrous ion with different scan rate from 10 to 500mV s<sup>-1</sup> in 0.1wt% iron monosulfide suspensions, and the dependence of the peak charges on scan rates. Although  $I_p$  of ferrous ion peak increased with the scan rate as showed in Figure 3.4, the peak width at half height and the background current also largely enhanced. In this case, the scan rate was decided at 10 mV s<sup>-1</sup> for ferrous ion analysis.



**Figure 3.4** Linear sweep voltammograms of ferrous ion with different scan rates in 0.1wt% FeS suspension samples (from inner to outer curve: 10, 20, 50, 100, 250 and 500mV/s) and the effect of the scan rate on the current of ferrous ion peak.

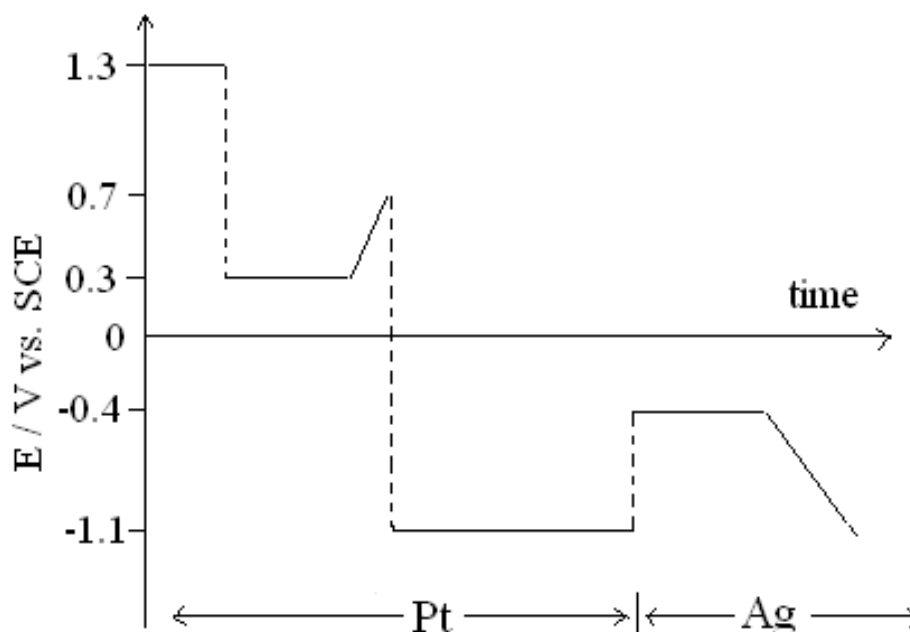
In conclusion, linear sweep voltammetry with the following conditions can be used for the determination of ferrous ion, providing good quality ferrous ion peak: accumulation potential is 0.3V; accumulation time is 120 s; scan rate is 10mV s<sup>-1</sup>.

Therefore, an effective methodology of the determination of FeS and FeS<sub>2</sub> in suspensions by ferrous ion analysis is obtained which is especially important to provide a prospective possibility in total content analysis whenever the FeS and FeS<sub>2</sub> are simultaneously being considered.

### ***3.3.4 Determination of Ferrous Ion from the Electrolytic Oxidation of Iron Sulfide in Suspension***

After optimizing the experimental conditions, the correlation between the concentration of ferrous ion and the weight percent of iron sulfide was obtained for the quantificational analysis in the suspension. We performed this experiment at the following the electroanalytic procedure (see Figure 3.5):

- (1) The electrolytic oxidation on Pt electrode at 1.3V (vs. SCE) for one minute;
- (2) The accumulation of ferrous ion on Pt electrode at 0.3V for 2 min;
- (3) The linear sweep voltammetry for the ferrous ion analysis on Pt electrode scanning from 0.3V to 0.7V.



**Figure 3.5** The potential profile of the proposed electroanalytic procedure for the ferrous ion analysis.

When the twin electrode parameters and the electrolytic oxidation conditions were preset, the produced ferric ion concentration was only dependent on the iron sulfide content. The ferrous ion originated from the reduction of ferric ion, therefore also depended on the iron sulfide content. With increasing of iron sulfide wt%, the ferrous ion concentration increases linearly, as shown in Figure 3.6 and Figure 3.7. There were two good linear correlations obtained for the analytical curve of the ferrous ion in the FeS and FeS<sub>2</sub> standard suspensions.

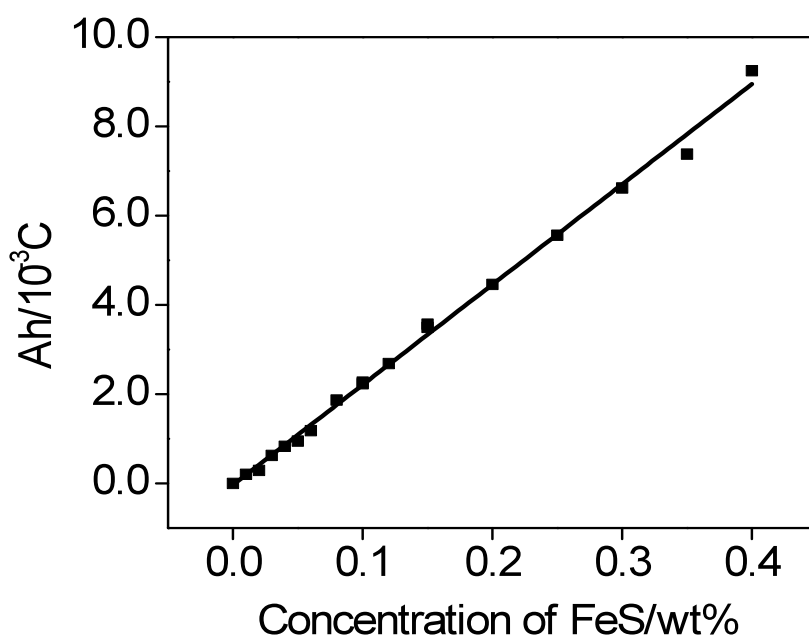
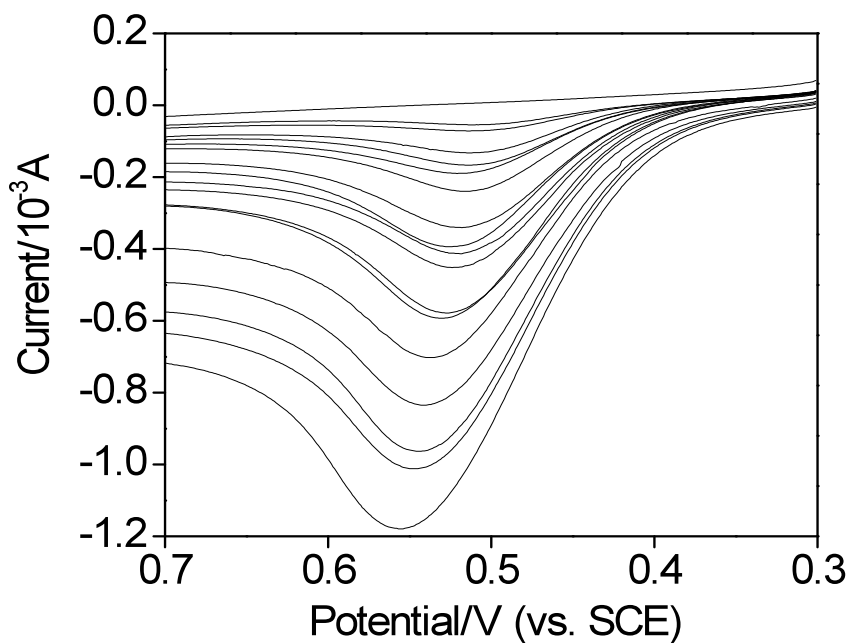
The parameters of the concentration vs. peak charge were calculated using the linear sweep voltammetry technique. The analytic curves were linear with correlation coefficient ( $R^2$ ) of 0.9965 and 0.9822 for ferrous ion of FeS and of FeS<sub>2</sub> respectively. The regression analysis data were calculated for ferrous ion as shown in the following equations:



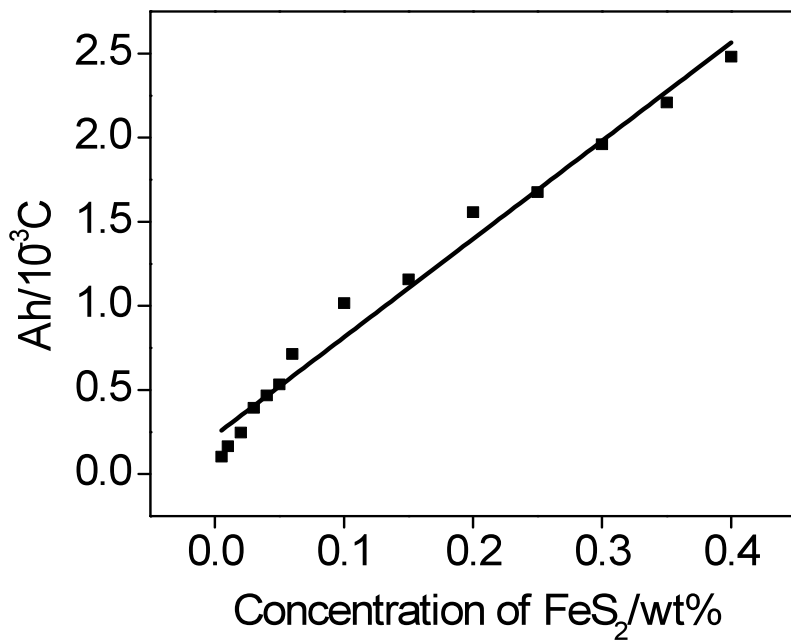
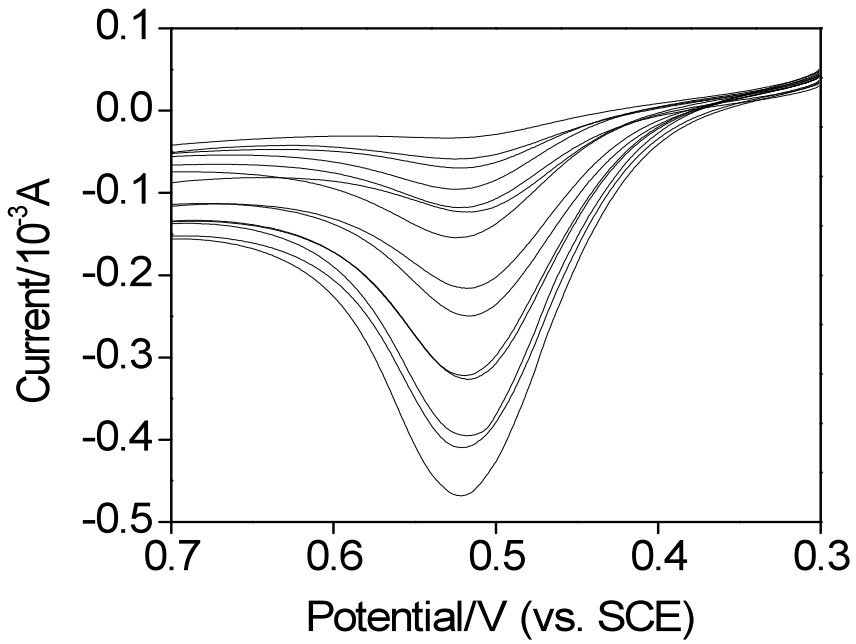
$$A_h (1e-3C) = -0.035 + 22.454 C \text{ (wt\%)} \text{ (Figure 3.6)}$$

$$A_h (1e-3C) = 0.2294 + 5.8386 C \text{ (wt\%)} \text{ (Figure 3.7)}$$

Although the concentration of hydrogen peroxide which is produced from the electrolysis of water is extremely high, the actual amounts of ferric ion are lower enough than those should be produced by hydrogen peroxide and iron sulfide according to eqs 2.2, indicating that the generated hydrogen peroxide can not oxidize all of the iron sulfide in the suspension within the given electrolytic oxidation time. That is, not all of iron sulfide in the suspension is oxidized. However, if we prolong the electrolytic oxidation time more than certain extent, the more hydrogen peroxide, the more oxygen gas is produced between the twin electrode. Thus, the amount of ferric ion depends on the rate of reaction between hydrogen peroxide and iron sulfide, and the reaction rate is in proportion to the concentration of hydrogen peroxide and the amount of iron sulfide in the suspension. For an unknown suspension sample, we can estimate the content of FeS or FeS<sub>2</sub> from the measured concentration of ferrous ion after electrolytic oxidation at 1.3V for one minute when we regard these two curves in Figure 3.6 and Figure 3.7 as the calibration curve *a* and the calibration curve *b*. For an unknown mixture suspension sample, the contents of FeS and FeS<sub>2</sub> may also be evaluated from the total measured concentration of ferrous ion.



**Figure 3.6** Voltammograms and dependency of generation of ferrous ion on the FeS wt% in the suspensions using linear sweep voltammetry.



**Figure 3.7** Voltammograms and dependency of generation of ferrous ion on the FeS<sub>2</sub> wt% in the suspensions using linear sweep voltammetry.

### 3.4 Conclusions

Voltammetry methods can be used to analyze electrochemically active species in the solutions and suspensions and have high sensitivity for the determination of concentration of the species. In this chapter, according to cyclic voltammetry, we found that the ferrous ion can be detected with our Pt-Ag twin electrode in the iron sulfate solution. Because iron sulfide is slightly soluble in water, it is difficult to analyze it directly by electrochemical method. However, after being electrolytically oxidized in twin electrode, insoluble iron sulfide can be transformed into soluble ferric ion and elemental sulfur. This makes it possible to determine the iron sulfide using voltammetry method. We investigated the mechanism of the ferrous ion analysis in the suspension by linear sweep voltammetry with the twin electrode. Moreover, the optimization of the linear sweep voltammograms was explored and found that accumulation time of 120 s at 0.3V for ferrous ion accumulation and scan rate of  $10\text{mV s}^{-1}$  are the optimal voltammetric conditions for ferrous ion analysis. We applied this electroanalytic procedure in the FeS and FeS<sub>2</sub> standard suspension samples and obtained two calibration curves with good correlation coefficient. When the proposed method was applied in an unknown suspension sample, the content of FeS and FeS<sub>2</sub> can be evaluated from the measured concentration of ferrous ion by these two calibration curves.

Therefore, we can determine the FeS and FeS<sub>2</sub> contents by the measured amount of ferrous ion in the independent suspension samples by our proposed electrochemical method with Pt-Ag twin-electrode, and will report the determination of FeS from the measured amount of silver sulfide and the calibration of the method in the next chapter.

## CHAPTER 4

### DETERMINATION OF IRON MONOSULFIDE BY ANALYSIS OF SULFIDE ION WITH TWIN ELECTRODE IN SUSPENSIONS

#### 4.1 Introduction

The sulfur cycle in the environment is complex due to the wide variety of naturally-occurring forms and oxidation states <sup>[83]</sup>. Sulfur-containing minerals are precipitated and accumulate under different physicochemical conditions and through several pathways, in marine, lacustrine and riverine sediments. During early diagenesis of sediments, bacterial sulfate reduction occurs under anoxic conditions and produces hydrogen sulfide as a byproduct <sup>[9]</sup>. On the other hand, ferrous iron is produced from reducible minerals such as iron oxides and silicates in buried sediments, and reacts with dissolved sulfides to give authigenic iron sulfides <sup>[30,84,85]</sup>, usually present in the form of pyrite ( $\text{FeS}_2$ ), or mackinawite ( $\text{FeS}$ ), which is the most common metal sulfide in sediments. This may lead to the deposition of insoluble metal sulfides. The acid volatile sulfides (AVS) can be considered as a measure of mobilizable sulfides, mainly iron monosulfide <sup>[86]</sup>. The relationship of AVS:free metal ion has been used as an indicator of sediment quality <sup>[87]</sup> since metal ions are present as insoluble sulfides, as long as excess AVS is present <sup>[60]</sup>.

Industrial processes, domestic effluents and the lack of sufficient wastewater treatment plants can lead to high sulfide concentrations in aquatic sediments. Thus, the determination of sulfide, such as iron sulfide, is important, not only for knowledge of the sulfur cycle, but also for the identification of trace elements in the aquatic environment. The AVS fraction and insoluble iron sulfide should be routinely analyzed in sediments. Accordingly, reliable analytical methods for iron sulfide monitoring should be easily available, providing good sensitivity, reproducibility and

accuracy and automatic methods for continuous monitoring are necessary.

Methods described for the determination of AVS in sediments use acidification at high temperature, followed by trapping of the resulting hydrogen sulfide by precipitation with metal solutions<sup>[88]</sup>. Final measurements are normally carried out by colorimetry<sup>[89]</sup>, gravimetry, potentiometry using ion-selective electrode<sup>[90]</sup>, or a chromatographic system<sup>[91]</sup>. Although analysis methods for AVS determination are well established, nevertheless, there is no method available for AVS and insoluble iron sulfide simultaneous determination in sediments that permits the analysis of a large number of samples per day, with good precision and accuracy.

In this chapter, we present a new electroanalytic procedure that can determine the solid FeS content by the measured sulfide ion amount in the suspension by electrochemical method with a Pt-Ag twin electrode. This technique has three features described as follows:

1. On Pt electrode, we perform electrolytic oxidation of iron sulfide in the suspension at 1.3V (vs. SCE) for one minute, converting insoluble iron sulfide into soluble ferric ion and elemental sulfur.

2. Before the determination of FeS, we optimize the linear sweep voltammogram for silver sulfide analysis in the suspension and decide the suitable experimental conditions.

3. After the measurement of ferrous ion, the concentration of silver sulfide is determined on Ag electrode by linear sweep voltammetry measurement. According to this, FeS content in the suspension can be evaluated from the measured silver sulfide concentration.

## **4.2 Experimental Section**

### ***3.2.1 Sample Preparation and Apparatus***

All the reagents, except for iron disulfide (FeS<sub>2</sub>), were purchased from Nacalai

Tesque, Inc. and used without further purification. Reagent FeS<sub>2</sub> was purchased from Kishida Chem. Inc.. All solutions were prepared using deionized water by Milli-Q system (Millipore Corp.). Suspension samples were made by uniformly dispersing FeS and FeS<sub>2</sub> powder into a disperse medium. The reagent of iron monosulfide (FeS) has been crushed for 3 minutes before use; the disperse medium consisted of 0.5 mol L<sup>-1</sup> sodium chloride (NaCl) and 0.4 mol L<sup>-1</sup> poly-vinylpyrrolidone (PVP) in aqueous solution. Standard suspension samples of sulfide ion used for quality assurance and calibration were prepared by adding FeS and FeS<sub>2</sub> to the disperse medium respectively, using analytical-grade reagents for all chemicals. A conventional electrochemical cell was used containing a platinum-silver (Pt-Ag) twin-electrode as the working electrode, a reference electrode of saturated calomel electrode (SCE) and a platinum wire ring as an auxiliary electrode. The Pt-Ag twin-electrode was polished with alumine (0.3 μm) and washed with water, and purged by oxidation potential of 1.0V on Pt electrode and reduction potential of -1.2V on Ag electrode respectively in the 0.5 mol L<sup>-1</sup> NaCl aqueous solution before each electroanalysis process. The voltammetric measurements were carried out in an ALS CH Instruments Electrochemical Analyzer Model 701C.

All potentials are quoted to this SCE reference electrode. All experiments were conducted at room temperature (ca. 25°C).

### ***3.2.2 Electroanalysis Procedures***

The analytical methodology for releasing ferric ion and elemental sulfur from the electrolysis of FeS and FeS<sub>2</sub> was the following: The electrolytic oxidation was applied on the Pt electrode at 1.3V for 1 min to generate ferric ion and elemental sulfur in the FeS and FeS<sub>2</sub> suspensions, which were previously deaerated with argon gas for 15 min.

After the measurement of ferrous ion, the deposition potential of -1.2V was applied to deposit iron by the reduction of ferric ion on the Pt electrode. At the same time, the

elemental sulfur was also reduced to sulfide ion in the suspension. In this case, the silver sulfide was formed by the oxidation of silver and the subsequent reaction with sulfide ion on the Ag electrode, and measured by linear sweep voltammetry. The deposition step lasted 120 s at potential of -0.4V for silver sulfide deposition. After a 2 s quiescent time, the sweeping step was performed from -0.4 to -1.2V for silver sulfide analysis. The scan rate was  $50\text{mV s}^{-1}$ . A current-potential curve can be obtained in linear sweep voltammogram. We can evaluate the silver sulfide concentration which is calculated from the charge amount of the curve and proportional to the measured charge amount. Calibration was carried out with FeS standardized suspensions. Finally, the content of FeS can be evaluated from the measured concentration of silver sulfide with the calibration curve.

In the linear sweep voltammetric experiments using FeS standardized suspensions (concentration of 0.1wt%), linear sweep scanning was also used with an deposition potential varying from -0.2 to -0.7V for silver sulfide; an deposition time varying from 0 to 120 s at potential of -0.4V; scan rates from 10 to  $500\text{mV s}^{-1}$ .

When 70.0 mL of the suspension sample was transferred to the voltammetric cell and analyzed using the linear sweep voltammetric techniques, the voltammograms were obtained.

## **4.3 Results and Discussion**

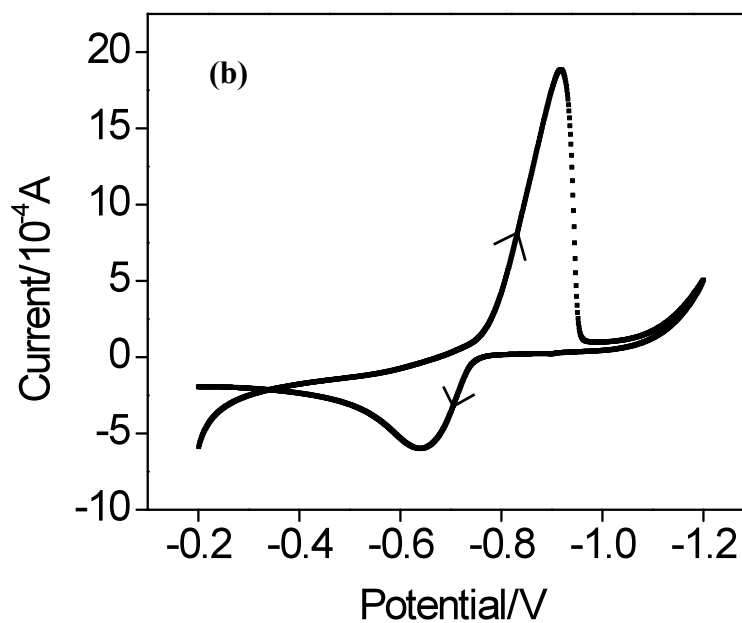
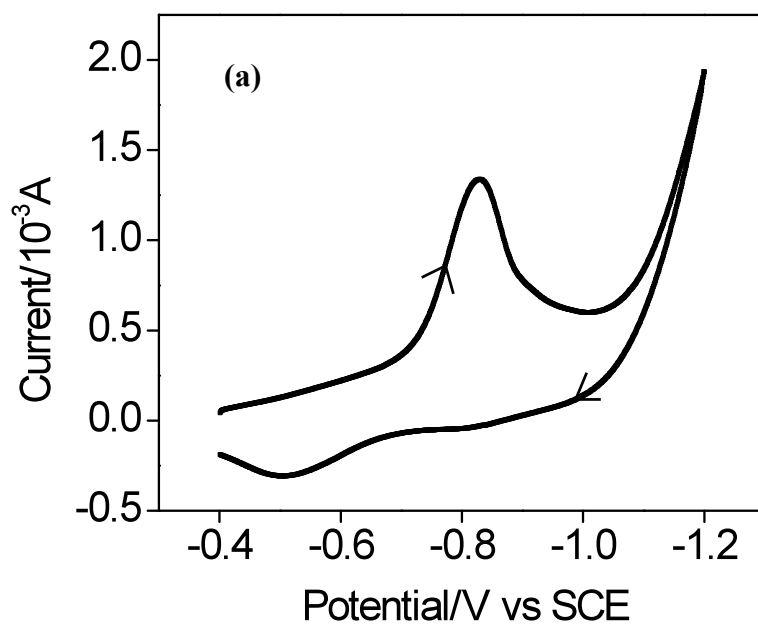
### ***4.3.1 Identification of Sulfide Ion Peak Generated from Iron Monosulfide in Suspension***

We performed a cyclic voltammetry to explore the electrochemical characteristics of the sulfur species in iron sulfide suspension with the Pt-Ag twin-electrode. Due to the low concentration of electrochemically active species in the solid iron sulfide suspension, the electrochemical response of sulfide can not be observed by normal cyclic voltammetry. However, we observed a well-defined reduction wave from the



cyclic voltammogram after applying the oxidation potential of 1.3V (vs. SCE) to the Pt working electrode for one minute. The peak consists with that in the cyclic voltammogram of silver sulfide (see Figure 2.3 Ab), suggesting that the sulfide ion may originate from the reduction of elemental sulfur which is generated from the electrolytic oxidation of FeS in the suspension samples, and can be determined in the linear sweep voltammetry on the Ag electrode. However the potential response from sulfur species can not be observed even after electrolytic oxidation in the FeS<sub>2</sub> suspension (see Figure 2.3 Bb). To confirm this prediction, the following experiments were carried out.

We performed a similar cyclic voltammetry in the sodium sulfide (Na<sub>2</sub>S) of 0.5M NaCl aqueous solutions the same as in the suspension sample with Ag electrode in the same twin electrode. We observed the potential response from sulfide ion (see Figure 4.1) same as that in the FeS suspension. That indicates that the proposed electrochemical method can be applied to determine the FeS in the suspension by the measurement of sulfide ion.

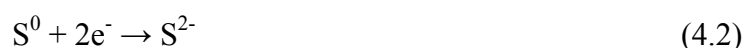


**Figure 4.1** Cyclic voltammograms of silver sulfide peak in different samples. (a) iron monosulfide, (b) sodium sulfide.

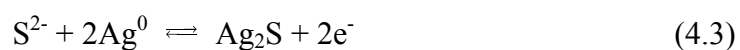
### ***4.3.2 The Mechanism of Sulfide Ion Analysis in Suspension by Linear Sweep Voltammetry with Twin Electrode***

Iron sulfide can be transformed into the dissolved ferric ion and elemental sulfur after electrolytic oxidation in the suspension. The following shows an example of sulfide ion measurement.

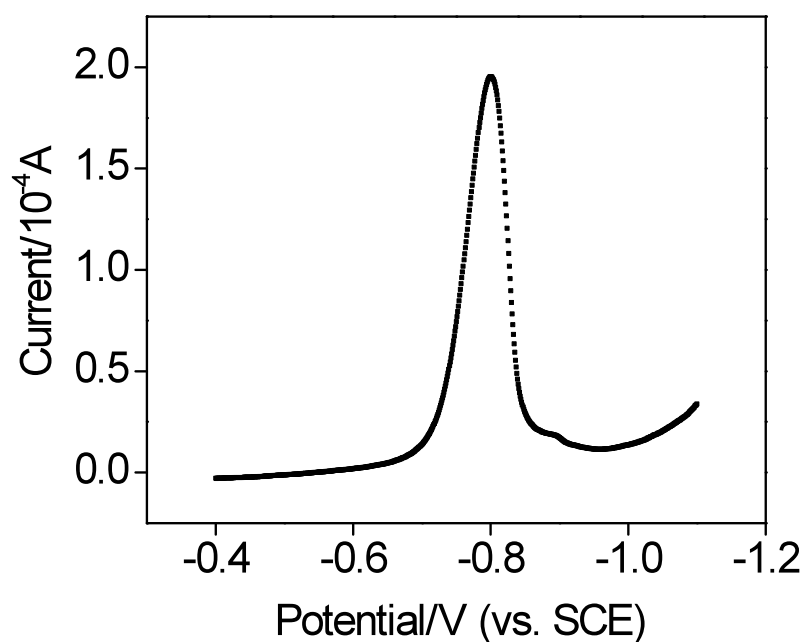
We disperse the crushed FeS in a 0.5M NaCl aqueous solution containing polyvinylpyrrolidone to prepare the suspension sample of 0.1wt% FeS. The twin electrode is placed into the suspension at 25°C, and is applied the oxidation potential of 1.3V (vs. SCE) for one minute. After electrolytic oxidation, the elemental sulfur is generated and dissolved into the suspension. However, elemental sulfur can not be determined directly by the linear sweep voltammetry with the twin electrode. To eliminate the reduction current of ferric ion in the suspension in the determination of silver sulfide, the deposition process of iron is performed by reducing ferric ion at -1.2V (vs. SCE) on Pt electrode surface after the measurement of ferrous ion. Elemental sulfur is also reduced to sulfide ion in the suspension at this potential. The processes can be described as eq. 4.1 and 4.2.



The generated sulfide ion has great affinity to the Ag electrode surface. Therefore in the depositing process at -0.4V, silver sulfide is formed on Ag electrode surface and tending to decompose to the elemental silver and sulfide ion by reducing in the cathodic scan. The silver sulfide presents a well-defined reduction peak at ca. -0.8V vs. SCE (see Figure 4.2). This figure shows that this peak is attributed to the reduction of silver sulfide to elemental silver by the transfer of two electrons, which generates a measurable current. The sulfide behavior mechanism on the silver electrode surface can be explained by eq. 4.3:



The trace of silver sulfide peak is detected by linear sweep voltammetry with the twin electrode. A current-potential curve can be obtained in linear sweep voltammogram. Based on the charge of the curve, we can determine the silver sulfide concentration which is calculated from the charge amount.

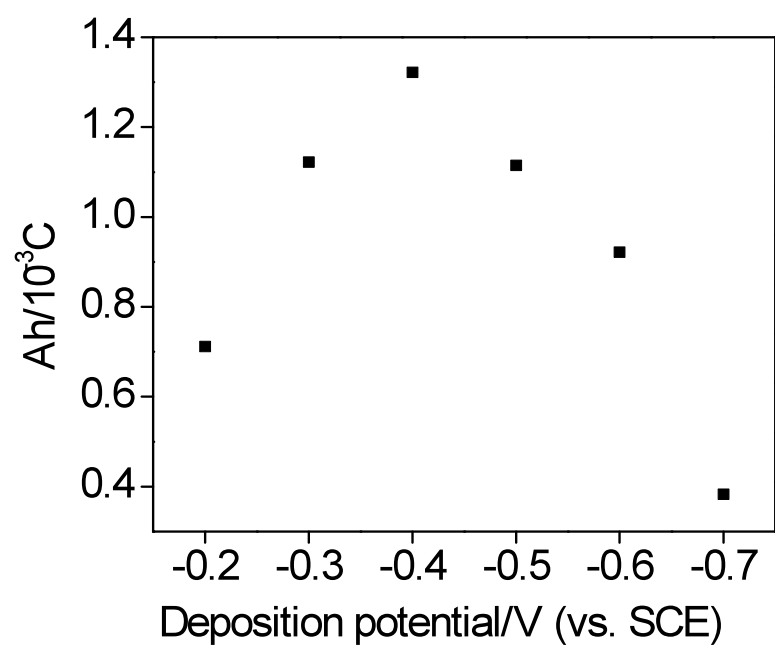
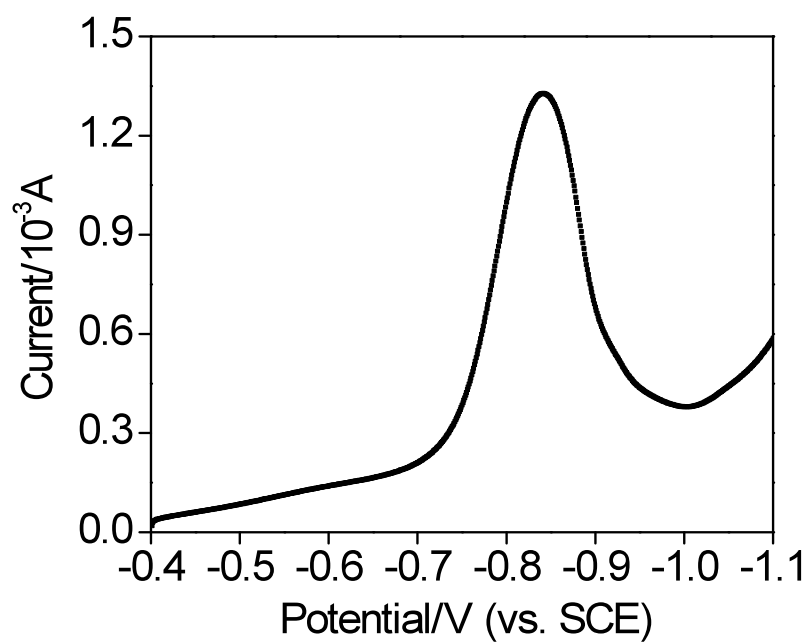


**Figure 4.2** Determination of concentration of sulfide ion in the suspension containing 0.1wt% iron monosulfide by linear sweep voltammetry after the electrolytic oxidation of sample at 1.3V for one minute.

### ***4.3.3 Optimization of the Linear Sweep Voltammogram for Silver Sulfide Analysis***

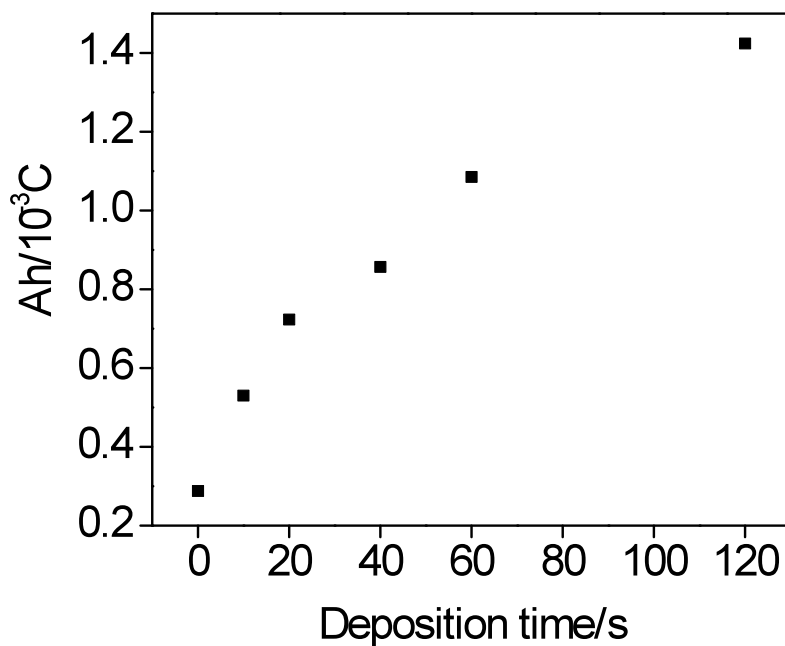
Before application of the voltammetric measurement in silver sulfide analysis, we evaluated the effect of the deposition potential, the deposition time and the scan rate in the linear sweep voltammogram of silver sulfide in the FeS suspensions.

Linear sweep voltammograms were obtained for 0.1wt% FeS in the suspensions, at  $50\text{mV s}^{-1}$  for different deposition potentials of silver sulfide ( $E_{\text{dep}}$ ), as shown in Figure 4.3, confirming that silver sulfide is produced on Ag electrode surface at the potential more than  $-0.7\text{V}$ : a stripping peak appeared at ca.  $-0.8\text{V}$  (vs. SCE). The largest charge of silver sulfide peak was observed with  $E_{\text{dep}} = -0.4\text{V}$ .



**Figure 4.3** Linear sweep voltammogram of 0.1 wt% FeS (Scan rate  $50 \text{ mV s}^{-1}$ ; deposition time 120 s at  $E_{\text{dep}} -0.4 \text{ V}$ ) and the effect of the deposition potential on the charge of silver sulfide stripping peak in the suspensions.

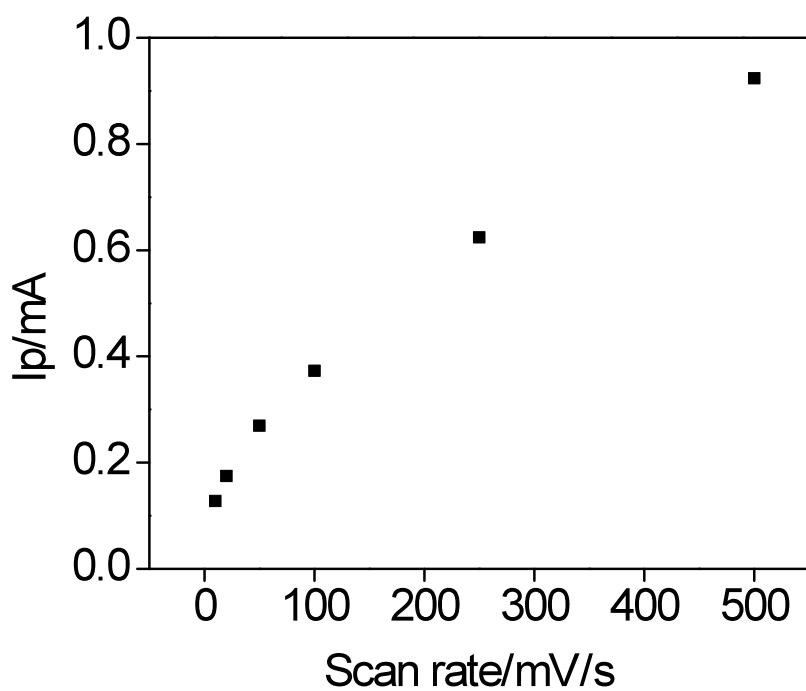
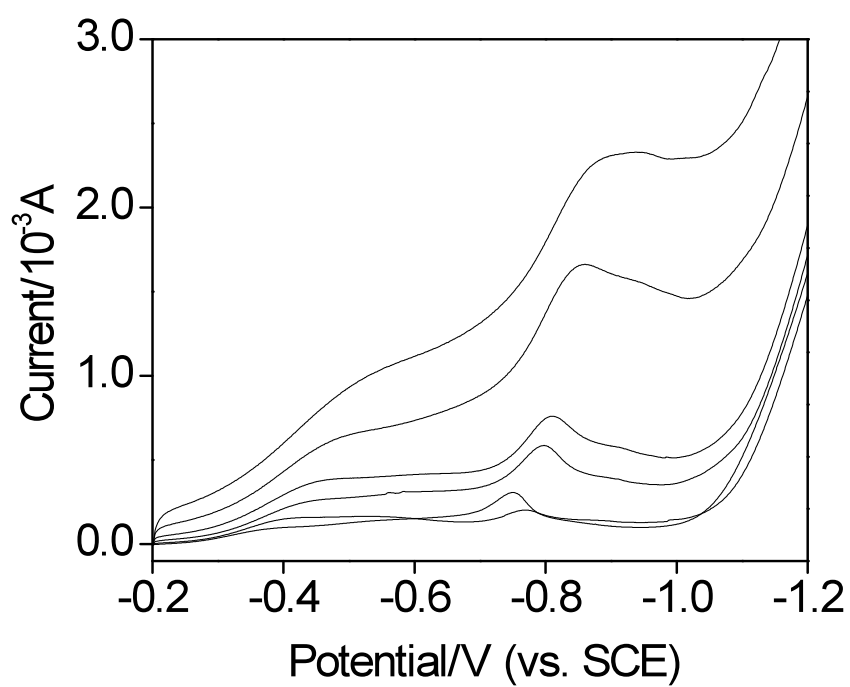
Further, the charge of silver sulfide peak depended linearly on the accumulation time, within the interval 0–120 s for silver sulfide (slope =  $0.008 \text{ mC s}^{-1}$ ;  $R^2 = 0.9887$ ;  $N = 6$ ) (see Figure 4.4). The linear dependence indicates that the charge amount is not saturated on electrode surface at accumulation time less than 120 sec. Therefore, within the concentration range 0.01–0.4wt% of FeS, accumulation time of 120 s for silver sulfide is suggested.



**Figure 4.4** Dependency of generation of silver sulfide on deposition time with deposition potential at -0.4V in the FeS suspensions.

Another important instrumental parameter in linear sweep voltammetry is the scan rate. Figure 4.5 shows the linear sweep voltammograms of silver sulfide with different scan rate from 10 to 500mV s<sup>-1</sup> in 0.1wt% iron monosulfide suspensions. Figure 4.5 indicates that the analytical signals of silver sulfide were improved with the increase of the scan rate, especially for scan rates lower than 100mV s<sup>-1</sup>. *I*<sub>p</sub> of silver sulfide peak depended linearly on the scan rate. In this case, the scan rate was decided at 50mV s<sup>-1</sup> for silver sulfide.





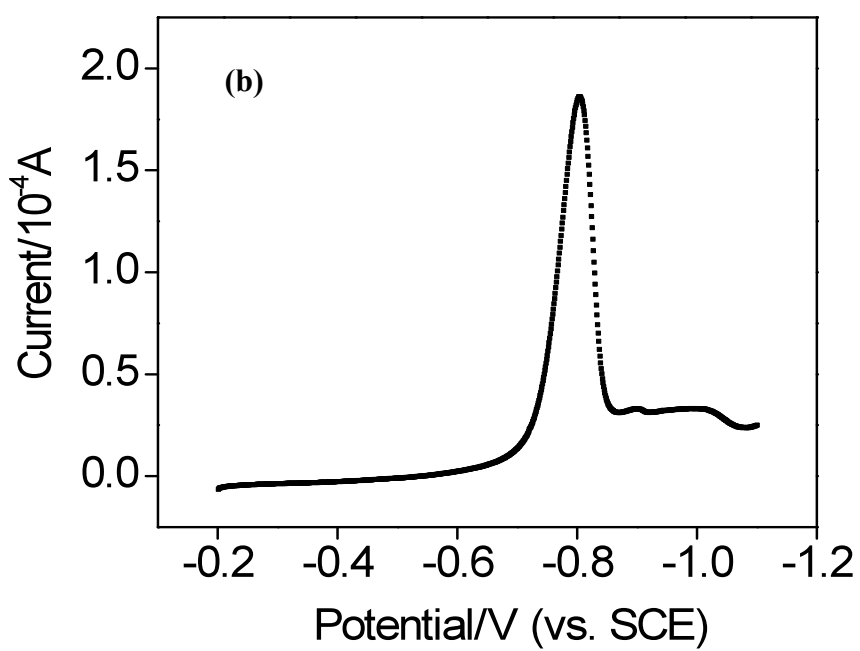
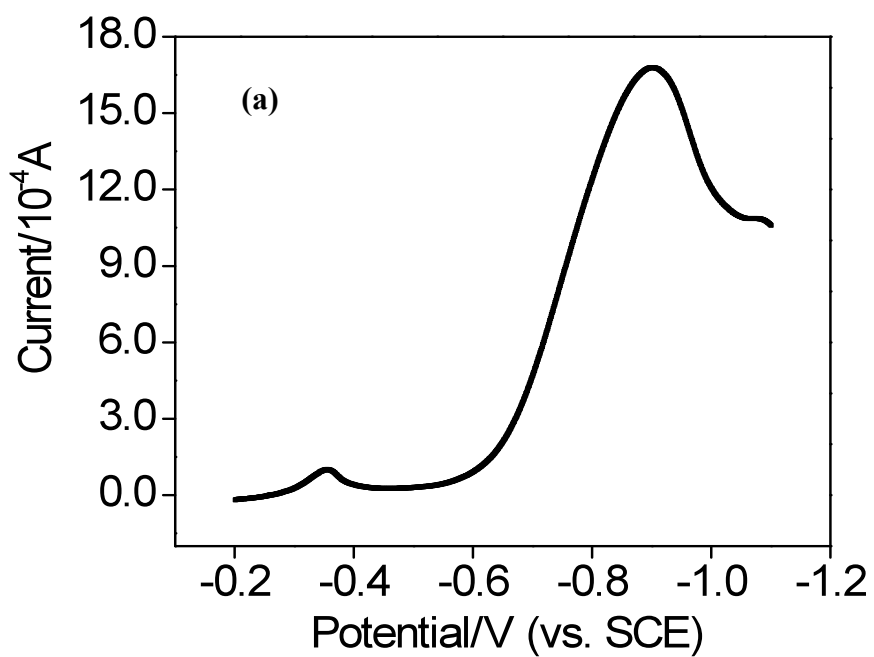
**Figure 4.5** Linear sweep voltammograms of silver sulfide with different scan rates in 0.1wt% FeS suspensions (from inner to outer curve: 10, 20, 50, 100, 250 and 500mV/s) and the effect of the scan rate on the current of silver sulfide stripping peak.

In conclusion, linear sweep voltammetry with the following conditions can be used for the determination of silver sulfide, providing good quality silver sulfide peak: deposition potential is -0.4V; deposition time is 120 s; scan rate is  $50\text{mV s}^{-1}$  for silver sulfide analysis.

Therefore, an improved methodology of the determination of solid FeS in suspensions by sulfide analysis is obtained which is especially important to provide a prospective methodology in environmental analysis whenever the seabed sludge containing a large number of acid volatile sulfide (AVS) is considered.

#### ***4.3.4 Effect of Iron Deposition at Pt Electrode Surface on the Determination of Silver Sulfide***

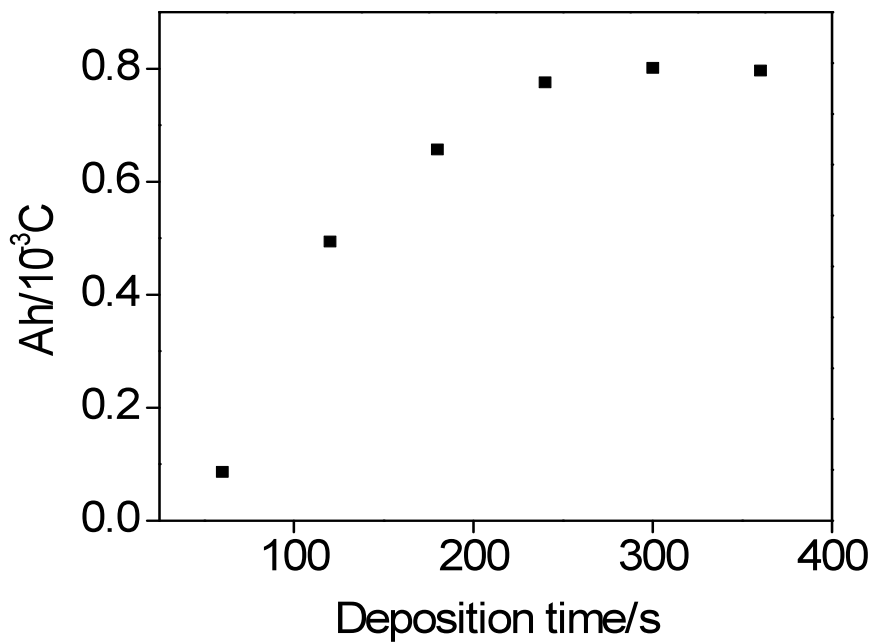
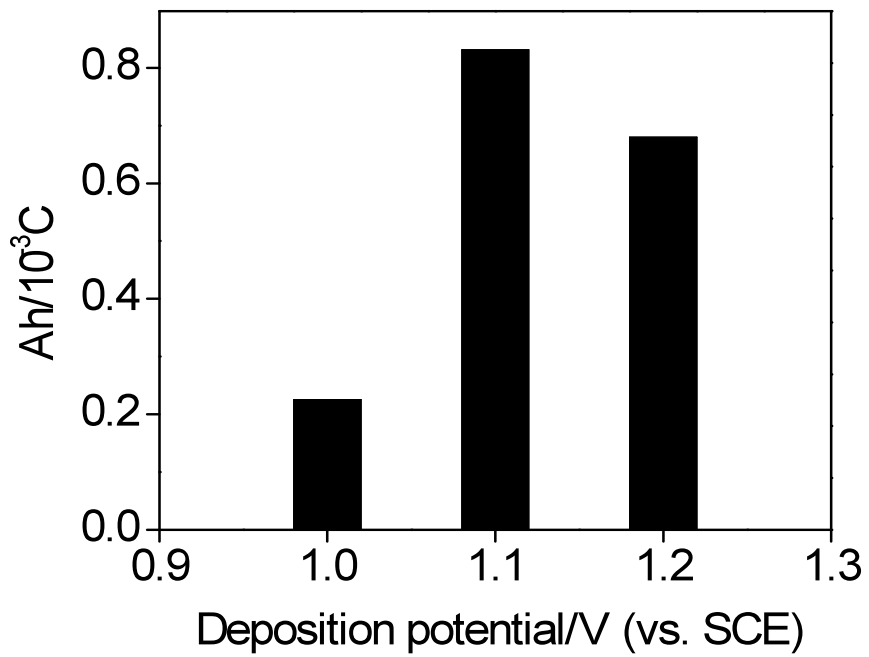
After the measurement of ferrous ion, ferric ion remained between the twin electrodes in the suspension. When we apply linear sweep voltammetry to determine the concentration of silver sulfide on the Ag electrode, iron is also deposited on the electrode surface at the positive scan. In this case, the iron deposition peak will cover on the silver sulfide peak so that we can not obtain the charge amount of silver sulfide peak (see Figure 4.6a). However, we can observe a well-defined silver sulfide peak in the voltammogram after iron is deposited on Pt electrode surface at the negative potential of -1.2V for 5min (see Figure 4.6b).



**Figure 4.6** Voltammograms of iron deposition peak and silver sulfide stripping peak in the FeS suspensions. (a) without iron deposition; (b) after iron deposition.

The deposition potential and deposition time of iron after ferrous ion measurement were evaluated in the FeS suspension. Three different reductive potentials were applied to deposit iron on Pt electrode surface. At the potential more than -1.0V, ferric ion can not be reduced into iron, and at the potential less than -1.2V, water is also electrolyzed into hydrogen gas which will make the measured value of silver sulfide unstable. According to the result in Figure 4.7, we decide the potential of -1.1V to deposit iron on Pt electrode surface and reduce the dissolved elemental sulfur to sulfide ion simultaneously in the suspension.

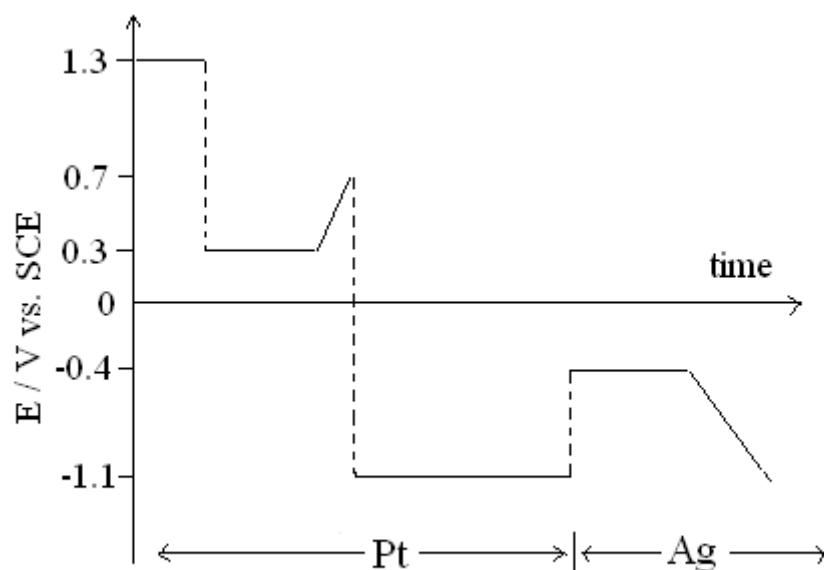
The dependency of iron deposition time on the measured silver sulfide amount at deposition potential of -1.1V in the FeS suspension was shown in Figure 4.7. The silver sulfide amount increased with the increasing of deposition time in the time interval of 60 sec to 300 sec. At the deposition time less than 60 sec, iron deposition peak and silver sulfide peak overlapped with each other completely so that we can not obtain the charge amount of silver sulfide peak.



**Figure 4.7** Effects of iron deposition potential and time on the determination of silver sulfide in the FeS suspensions.

### 4.3.5 Determination of Silver Sulfide from the Electrolytic Oxidation of Iron Monosulfide in Suspension

After optimizing the experimental conditions, the correlation between the concentration of sulfide ion and the weight percent of iron monosulfide was obtained for the quantificational analysis in the suspension. We performed this experiment at the following the electroanalytic procedure (see Figure 4.8): (1) the electrolytic oxidation on Pt electrode at 1.3V (vs. SCE) for one minute; (2) the accumulation of ferrous ion on Pt electrode at 0.3V for 2 min; (3) the linear sweep voltammetry for the ferrous ion on Pt electrode from 0.3V to 0.7V; (4) the deposition of iron on Pt electrode from 0.3V to 0.7V; (5) the deposition of silver sulfide on Ag electrode at -0.4V for 2 min; (6) the linear sweep voltammetry for the sulfide ion on Ag electrode from -0.4V to -1.2V.



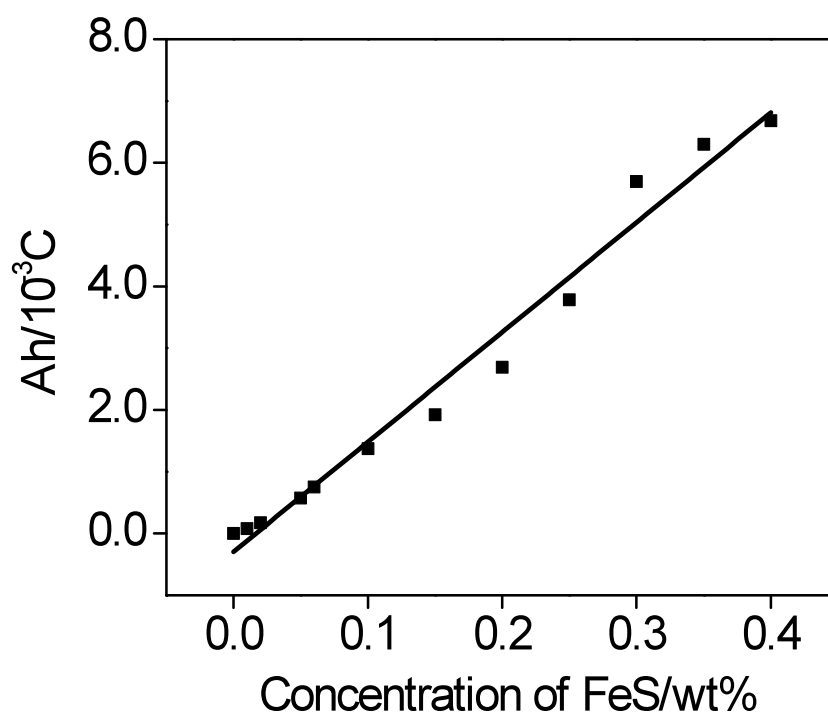
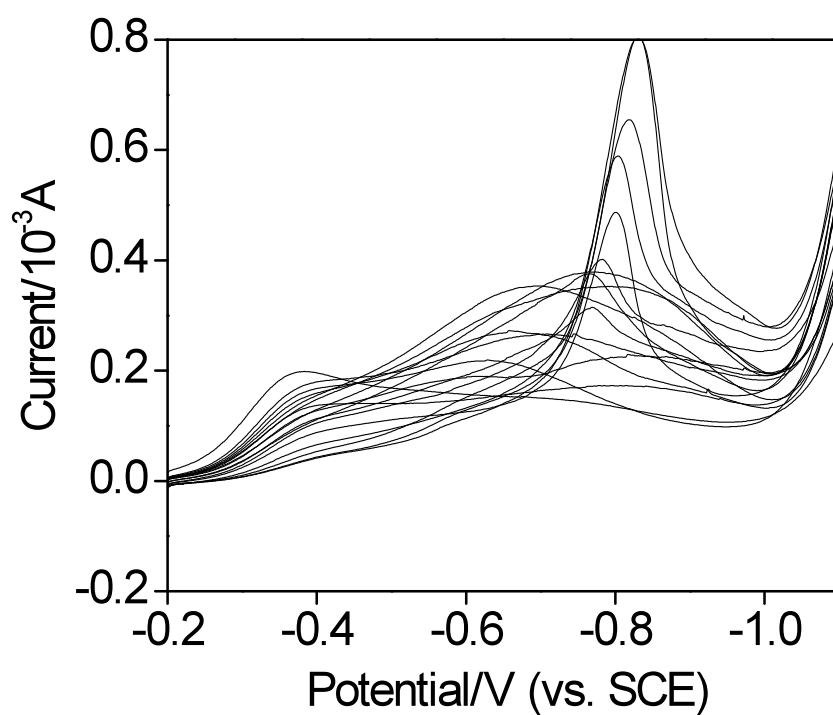
**Figure 4.8** The potential profile of the proposed electroanalytic procedure for the sulfide ion analysis.

We carried out this electroanalytic procedure to investigate the dependency of the concentration of silver sulfide on iron monosulfide wt% in the suspension. With increasing of iron monosulfide wt%, the silver sulfide concentration increases linearly, as shown in Figure 4.9. The primary sulfur species generated from the electrolysis of FeS is elemental sulfur, which can not be detected directly on Ag electrode using the linear sweep voltammetry. However, under the high negative potential such as -1.2V, elemental sulfur is reduced to sulfide ion so that FeS can be evaluated from the measured sulfide ion amount. Since elemental sulfur is just partially reduced, the measured sulfide ion amount is smaller than the generated elemental sulfur amount.

Iron disulfide has different electrochemical behavior with iron monosulfide from the electrolytic oxidation (see Figure 4.10). Polysulfur is generated from the electrolysis of FeS<sub>2</sub> and is the thermodynamically stable form, which can not be easily reduced to sulfide ion and react with silver electrode. Therefore, with the proposed electroanalysis procedure, we can not determine the sulfur species in the FeS<sub>2</sub> suspension. That means that we can only obtain FeS content from the measured silver sulfide amount when we regard the curve in Figure 4.9 as the calibration curve *c*. Moreover, we can obtain the contents of FeS and FeS<sub>2</sub> from the measured ferrous ion amount. Based on the above result, FeS and FeS<sub>2</sub> can be finally evaluated from the concentrations of ferrous ion and silver sulfide respectively.

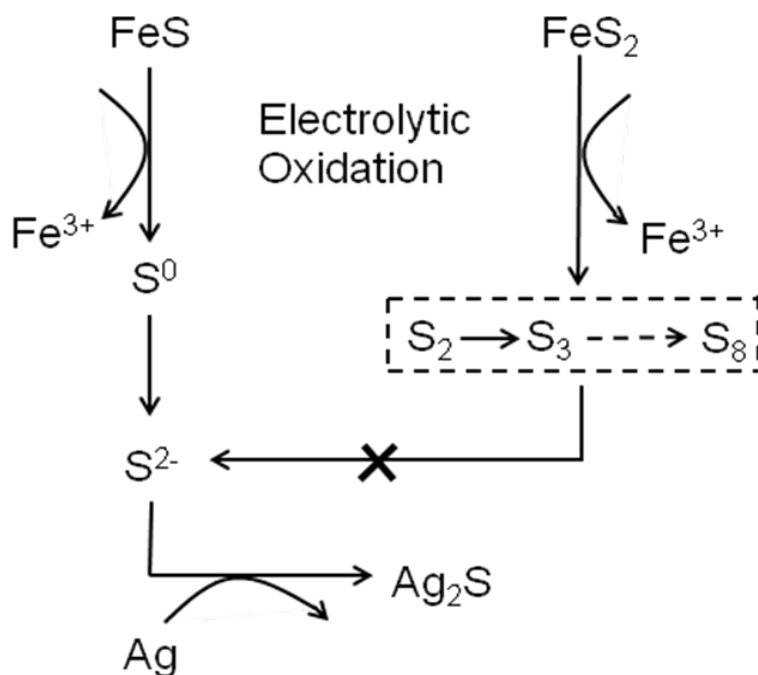
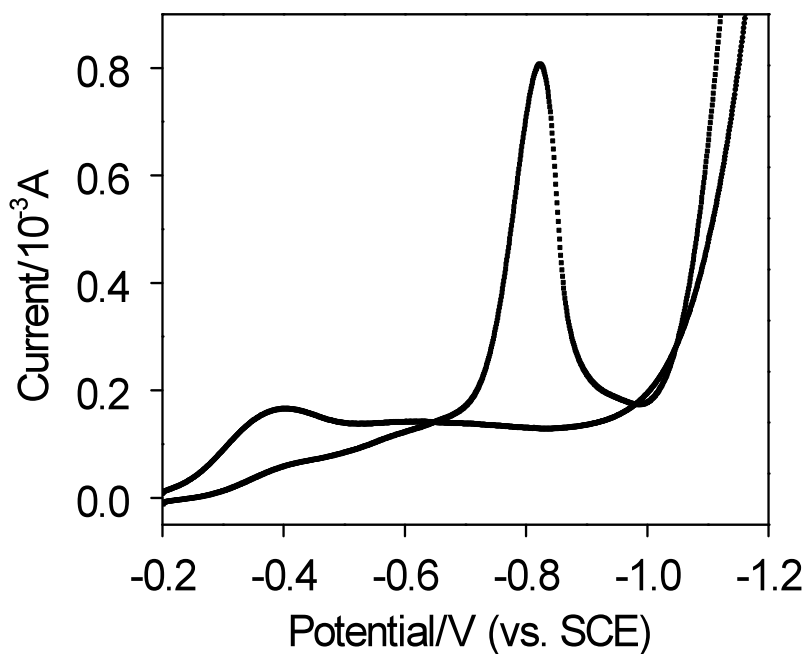
The limit of detection ( $3\sigma$ ) was 0.01 wt%. The precision of the developed method was verified from the repeatability of 5 determinations of 0.01wt% for each FeS and FeS<sub>2</sub> suspensions and the relative standard deviation (RSD%) was 2.68%, 1.84% and 2.85% for ferrous ion of FeS and of FeS<sub>2</sub> and for silver sulfide of FeS, respectively.

For a mixture suspension sample, the calibration curve *c* is also effective so that we can estimate FeS content from the measured silver sulfide amount after electrolytic oxidation at 1.3V for one minute by the proposed electrochemical method.



**Figure 4.9** Voltammograms and Dependency of generation of silver sulfide on the FeS wt% in the suspensions using linear sweep voltammetry.





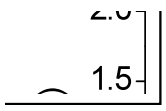
**Figure 4.10** Linear sweep voltammograms of silver sulfide in 0.1wt% iron sulfide suspensions and the mechanism of the generation of polysulfur from the electrolysis of iron disulfide.

## 4.4 Conclusions

Iron sulfide is an important reductive pollutant in sediments, the existence of which has harmful influence to the aqueous ecosystems, so that it is necessary to determine its content to protect the quality of water body. The proposed methodology provides a very sensitive determination of solid iron sulfide, which allows quantitative determination of iron monosulfide and iron disulfide in the suspension respectively. According to cyclic voltammetry, we found that insoluble iron sulfide was transformed into soluble ferric ion and elemental sulfur after being electrolytically oxidized in twin electrode, providing a possibility to determine solid iron sulfide concentration at suspension condition using linear sweep voltammetry.

After ferrous ion measurement, we attempted to determine the sulfur species generated from the electrolytic oxidation of FeS, and found that the existence of ferric ion result in the failure of sulfide ion measurement. So the negative potential was applied to deposit iron on Pt electrode and eliminate the influence of iron on sulfide ion measurement. After the optimization of voltammetry conditions, the sulfide ion was determined on the Ag electrode by linear sweep voltammetry and we found a good calibration curve between the measured silver sulfide amount and iron monosulfide wt%, although the method was not effective entirely in the determination of sulfur species generated from the electrolysis of iron disulfide.

The traces of ferrous ion peak and silver sulfide peak can be detected by technique of linear sweep voltammetry with twin electrode which was proposed in Chapter 3 and Chapter 4. Herein, there are two linear relations between the concentration of generated ferrous ion and the iron sulfide weight percent in the FeS and FeS<sub>2</sub> suspensions. According to these two linear relations, namely the calibration curve *a* and the calibration curve *b*, we can determine the contents of FeS and FeS<sub>2</sub> from the concentration of ferrous ion. On the other hand, the FeS weight percent in the suspension can be evaluated from the concentration of silver sulfide by linear sweep voltammetry using the calibration curve *c*. Therefore, a new electrochemical



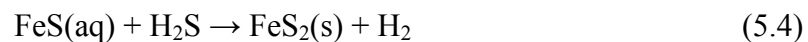
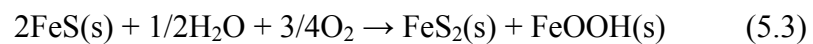
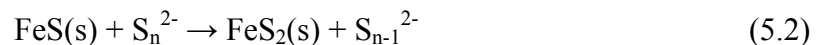
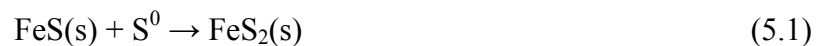
technique by Pt-Ag twin electrode is developed, which including electrolysis and linear sweep voltammetry, for the assay of FeS and FeS<sub>2</sub> in the suspensions.

# CHAPTER 5

## DETERMINATION OF IRON MONOSULFIDE AND IRON DISULFIDE CONTENTS BY FERROUS AND SULFIDE ANALYSIS IN MIXTURE SUSPENSIONS

### 5.1 Introduction

In unpolluted aquatic sediments, sulfur species are found in association with iron which is the most common metal in sediments, and are usually present in the form of pyrite ( $\text{FeS}_2$ ), or mackinawite ( $\text{FeS}$ ). The acid volatile sulfides (AVS) can be considered as a measure of mobilizable sulfides, mainly iron monosulfide. Due to the fact that AVS is metastable and pyrite is the thermodynamically stable, over time, sedimentary  $\text{FeS}$  tends to convert into thermodynamically favoured pyrite<sup>[50]</sup>, and the replacement does not mean converting  $\text{FeS}$  into pyrite directly<sup>[54]</sup>. Rather,  $\text{FeS}$  dissolves and pyrite forms, resulting in increasing pyrite-S to AVS ratios with time<sup>[31]</sup>. Pyritization in anoxic conditions often occurs by following several reactions:



Pyrite ( $\text{FeS}_2$ ) is the primary existence in the sedimentary sulfur components. Due to slow transformation rate, AVS may persist for long time in sediment<sup>[45,65]</sup>.

Therefore, it is necessary to be aware of the storage and transformation of  $\text{FeS}$  and  $\text{FeS}_2$  in sediments for determination of AVS. According to the results described in Chapter 3 and Chapter 4, we suppose that the proposed methods can be used to quantitatively analyze the iron monosulfide and iron disulfide in the mixture suspensions. Therefore, in this chapter, we applied the proposed electrochemical

methods to determine the FeS content and FeS<sub>2</sub> content by the measured concentrations of ferrous ion and sulfide ion with the same Pt-Ag twin electrode. This electroanalytic procedure includes three features described as follows:

1. We perform electrolytic oxidation of iron sulfide on Pt electrode of twin electrode in the suspension at 1.3V (vs. SCE) for one minute, converting insoluble iron sulfide into soluble ferric ion and elemental sulfur.

2. By the ferrous ion analysis, the contents of FeS and FeS<sub>2</sub> in mixture suspension were evaluated from the measured total concentrations of ferrous ion, which were calculated by the charge amount in the linear sweep voltammograms.

3. After the measurement of ferrous ion, the concentrations of sulfide ion in mixture suspension were determined from the charge amount in the linear sweep voltammograms. According to this, the FeS content can be evaluated from the measured sulfide ion concentration. We also discuss the validity and deviation of the developed method in mixture suspension samples.

## **5.2 Experimental Section**

### ***5.2.1 Sample Preparation***

Mixture suspension samples were made by uniformly dispersing FeS and FeS<sub>2</sub> powder into a disperse medium. The reagent of FeS has been crushed for 3 minutes before use; the disperse medium consisted of 0.5 mol L<sup>-1</sup> sodium chloride (NaCl) and 0.4 mol L<sup>-1</sup> poly-vinylpyrrolidone (PVP) in aqueous solution.

### ***5.2.2 Apparatus***

A conventional electrochemical cell was used containing a platinum-silver (Pt-Ag) twin-electrode as the working electrode, a reference electrode of saturated calomel

electrode (SCE) and a platinum wire as an auxiliary electrode. The electrolysis and voltammetric measurements were carried out in an ALS CH Instruments Electrochemical Analyzer Model 701C.

All potentials are quoted against this SCE reference electrode. All experiments were conducted at room temperature (ca. 25°C). When 70.0 mL of the mixture suspension sample was transferred to the voltammetric cell, the suspension was analyzed using the linear sweep voltammetric techniques.

## **5.3 Results and Discussion**

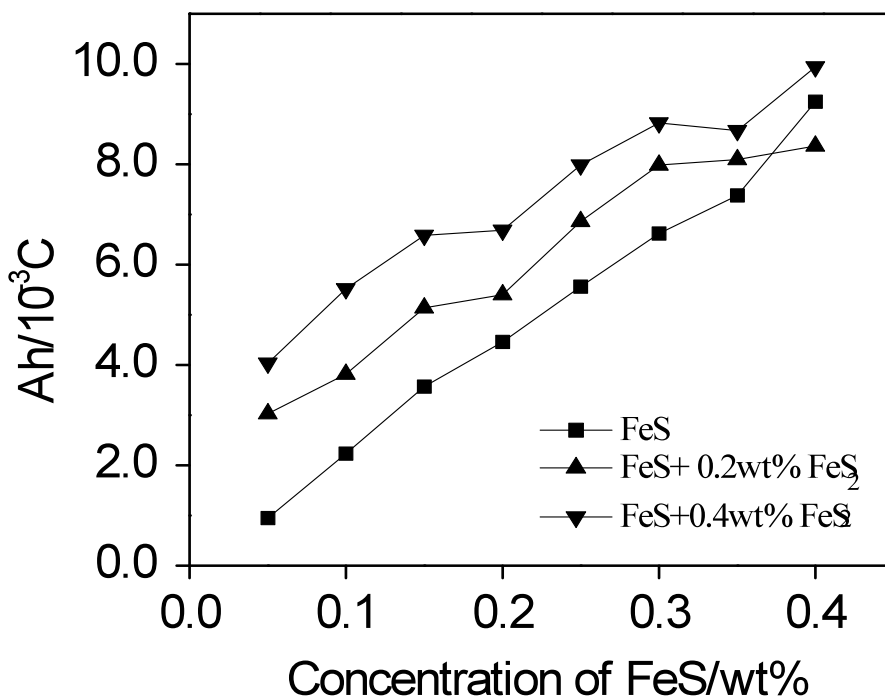
### ***5.3.1 Determination of the Contents of Iron Monosulfide and Iron Disulfide by Ferrous Ion Analysis in the Mixture Suspension***

Using the described electroanalytic method in Chapter 3 and Chapter 4, mixture suspension samples were analyzed. We regard FeS/FeS<sub>2</sub> suspension system as the mixture suspension samples, of which various amounts of FeS with 0.2wt% and 0.4wt% FeS<sub>2</sub>, and the various amounts of FeS and FeS<sub>2</sub> with total content of 0.45wt% are added to the disperse medium. The linear sweep voltammetry technique was used to determine the ferrous ion generated from three systems of mixture suspension samples. Trace of ferrous ion was found in the mixture sample in the linear sweep voltammogram after the samples were oxidized on Pt electrode. The total concentration of ferrous ion can be calculated from the peak charge amount. In this case, the calibration curve *a* and the calibration curve *b* were used to evaluate the contents of FeS and FeS<sub>2</sub> by the comparison of the measured ferrous ion concentration with the reference value.

We compare the measured ferrous ion concentration generated from the FeS samples with the mixture samples of FeS and FeS<sub>2</sub> in Figure 5.1. Three linear relationship curves were obtained, with slope of 1.1197, 0.818, 0.7749 and correlation

coefficient ( $R^2$ ) of 0.9932, 0.96, 0.9574. The similar slopes indicate that the measured concentrations of ferrous ion originated from the mixture suspension samples are accordant with the calibration curve *a* despite some deviation were observed between them. The deviation mainly occurred at the high FeS concentrations. One possibility may be explained by the addition of FeS<sub>2</sub> will influence the ferrous ion measurement of FeS by the competition reaction, especially at the high FeS concentrations.

In conclusion, the proposed method for ferrous ion analysis is effective for the samples of FeS and FeS<sub>2</sub> respectively in the individually dispersed suspensions, but for the samples of mixture suspension of FeS and FeS<sub>2</sub>, a deviation was observed between the mixture system and the calibration curve *a*. It needs more work to improve the accuracy of ferrous ion measurement in mixture suspension. Additionally, it indicates that we may need new calibration curves using other electrochemical methods such as chronoamperometry for the determination of the total content of FeS and FeS<sub>2</sub> in mixture suspension samples, for linear sweep voltammetry may be not accurate and reliable enough to obtain the total content of FeS and FeS<sub>2</sub>.



**Figure 5.1** Comparison of measured ferrous ion concentrations in the three different FeS/FeS<sub>2</sub> suspension systems.

### ***5.3.2 Determination of the Content of Iron Monosulfide by Sulfide Ion***

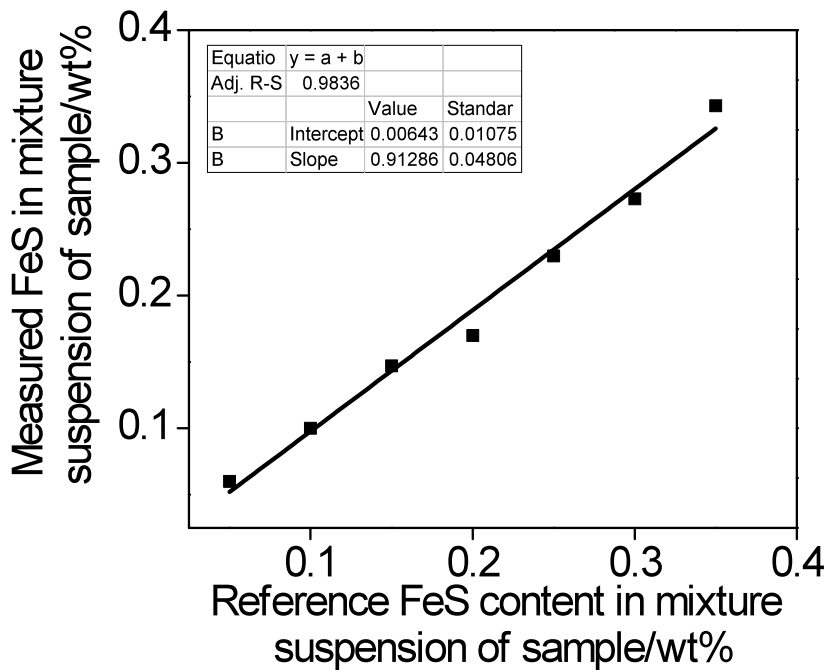
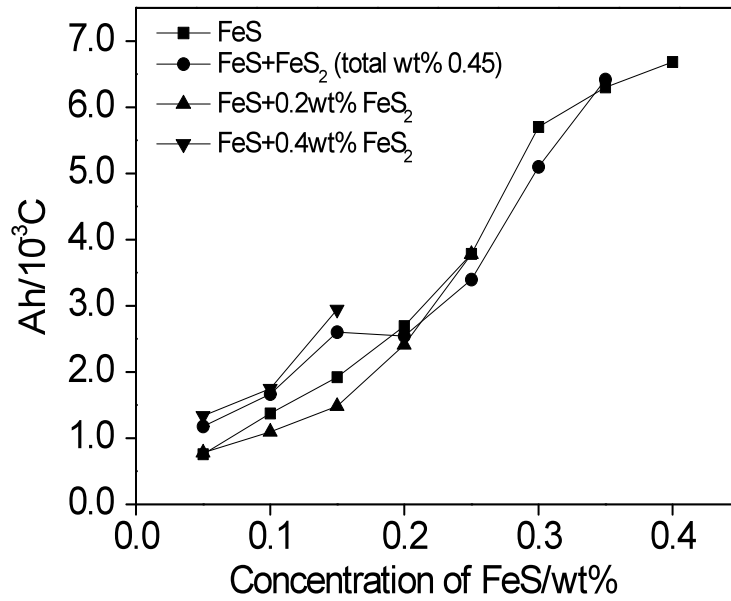
#### ***Analysis in the Mixture Suspension***

After ferrous ion measurement, the linear sweep voltammetry technique was used to determine the sulfide ion generated from three systems of mixture suspension samples. Traces of silver sulfide were found in the mixture samples in the linear sweep voltammograms after the samples were oxidized on Pt electrode. The concentrations of silver sulfide were calculated by their peak charge amount. In this case, the calibration curve *c* was used to calculate the FeS content by the comparison of the measured silver sulfide concentration with the reference value. In hypothesis, if we can also use the calibration curve *a* and the calibration curve *b* to determine the contents of FeS and FeS<sub>2</sub> in mixture suspension by the total measured ferrous ion



amount, which is introduced in Chapter 3, the  $\text{FeS}_2$  content can be calculated by subtracting the FeS content from the total content. Unfortunately, we failed in the ferrous ion measurement in mixture suspension samples, so that we can not obtain the FeS and  $\text{FeS}_2$  contents respectively for the mixture suspension system. Therefore, finally we can only determine the FeS content in the mixture suspension samples.

We compare the measured silver sulfide concentration generated from the FeS samples with the mixture samples of FeS and  $\text{FeS}_2$  in Figure 5.2. A good agreement relation was obtained between the three systems of mixture suspension samples and the reference curve. This indicates that the measured silver sulfide was only originated from the FeS samples and the existence of  $\text{FeS}_2$  has no influence on the measurement of FeS. In conclusion, the proposed method is effective for the FeS determination in the sample of mixture suspension of FeS and  $\text{FeS}_2$ . Additionally, it indicates that the calibration curve  $c$  from Figure 4.9 is reliable in the determination of FeS in mixture suspension samples.



**Figure 5.2** Consistency of silver sulfide concentrations in the four different FeS/FeS<sub>2</sub> suspension systems and the reference curve between the measured FeS content and the reference value (total content of FeS and FeS<sub>2</sub> is 0.45wt%).

## 5.4 Conclusions

The proposed methods can be used to quantitatively analyze the FeS in the mixture suspensions and obtain a good agreement between the measured FeS content and the reference value. In this chapter, according to voltammograms, we found that the traces of ferrous ion peak and sulfide ion peak can be detected by technique of linear sweep voltammetry with our Pt-Ag twin electrode in mixture suspension samples. After electrooxidation of mixture sample on Pt electrode, solid iron sulfide was transformed into soluble ferric ion which generated from both FeS and FeS<sub>2</sub>, and elemental sulfur which generated only from FeS and can be easily reduced. This provides a possibility to determine the FeS and FeS<sub>2</sub> respectively using this proposed method in the mixture suspension. We applied this electroanalytic procedure in four mixture suspension systems and obtained two reference curves, in which a good agreement relationship was obtained for FeS analysis. According to the calibration curve *c*, we can determine the content of FeS from the measured concentration of sulfide ion. However, a deviation between the measured ferrous ion concentration and the reference value of the calibration curve *a* was observed in four systems of mixture suspension samples.

After all, we can determine the FeS content by the measured concentration of sulfide ion in the mixture suspension samples by our proposed electrochemical method with Pt-Ag twin-electrode.

# CHAPTER 6

## CONCLUSIONS

This is the first investigation of solid phase iron sulfide ( $\text{FeS}$  and  $\text{FeS}_2$ ) in suspensions using platinum-silver twin-electrode after applying electrolytic oxidation of samples. The proposed methodology provides a very sensitive determination of solid iron sulfide, which allows quantitative determination of iron monosulfide and iron disulfide in suspensions respectively.

The results obtained through this work are summarized as follows:

### 6.1 Summary and Conclusions

Iron sulfide is an important reductive pollutant because it is widespread in the natural sediments. The detection methods for the acid volatile sulfide (AVS) are not effective for solid iron sulfide because which can not produce electrochemically active species to be detected by electrochemical methods.

In this thesis, we propose a new technique which can respectively determine the  $\text{FeS}$  content and  $\text{FeS}_2$  content in suspensions by electrochemical methods including electrolysis and linear sweep voltammetry with Pt-Ag twin electrode, as shown in Figure 6.1.

In general, the concentration of electrochemically active species in the suspension of solid iron sulfide is extremely low. This is disadvantageous to the determination of these species by electrochemical method. The solution to the problem is applying electrolytic oxidation to the suspension. By electrolysis at 1.3V (vs. SCE) for one minute, the insoluble iron sulfide is transformed into soluble ferric ion and elemental sulfur, and dissolved in the suspension, as described in Chapter 2. According to cyclic voltammetry, we found that ferric ion and elemental sulfur were generated from iron

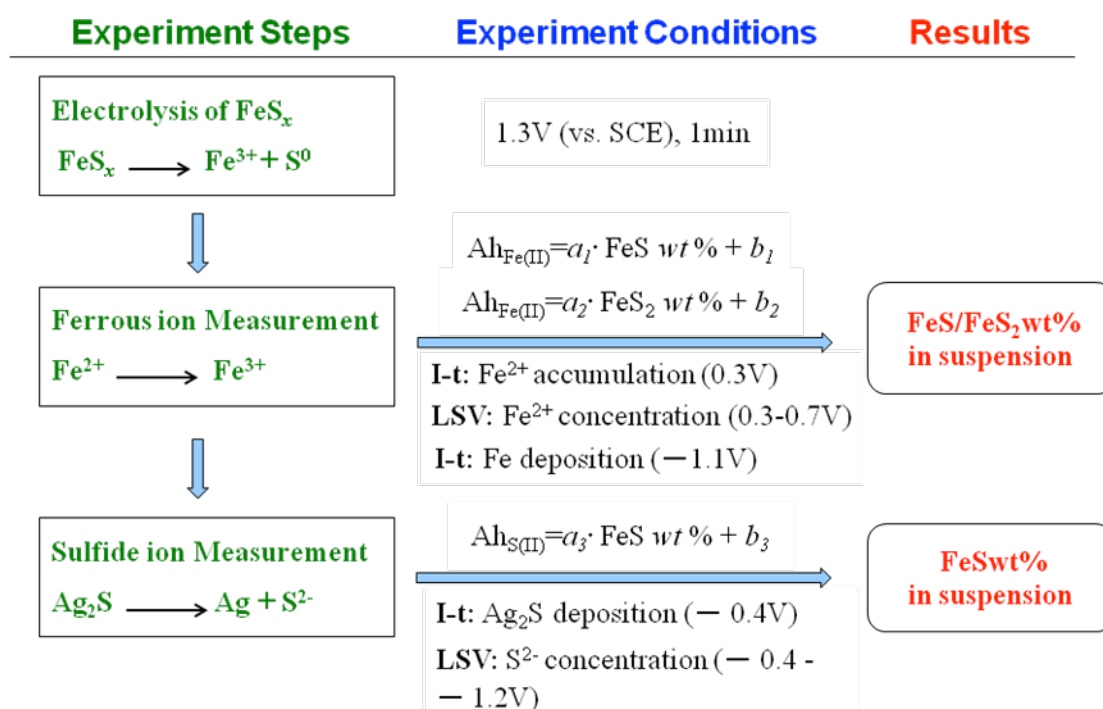
sulfide after electrolytic oxidation on the Pt electrode and reduced to ferrous ion and sulfide ion, which provides a possibility for the determination of solid iron sulfide content in the suspension using linear sweep voltammetry.

The effects of oxidation potential and oxidation time on the analysis of ferrous ion and silver sulfide were studied, and the experimental conditions of voltammetry were also optimized. The concentrations of ferrous ion and silver sulfide generated from iron sulfide after electrolysis are dependent on the oxidation potential and oxidation time. There are linear relationships of the amounts of the generated ferrous ion and silver sulfide against oxidation potential and oxidation time. The ferric ion and elemental sulfur can be reduced to the ferrous ion and sulfide ion electrochemically, so that it is possible to determine the concentrations of ferrous ion and sulfide ion by our proposed electroanalysis procedure. The linear sweep voltammetry was applied to determine the generated ferrous ion and sulfide ion so that the iron sulfide content can be evaluated from the measured concentrations of ferrous ion and sulfide ion.

Voltammetry measurements show three linear relationships between the iron sulfide content and the concentrations of ferrous ion and silver sulfide originating from the reduction of ferric ion and elemental sulfur. According to the calibration curve *a* and *b*, linear relations were found between the weight percent of iron sulfide and the concentration of ferrous ion in the suspension, as described in Chapter 3, so that we can evaluate the weight percents of FeS and FeS<sub>2</sub> from the amount of measured ferrous ion by linear sweep voltammetry in the suspension. After optimizing the voltammetry conditions, the contents of FeS and FeS<sub>2</sub> in the mixture suspension samples were also evaluated from the total measured concentration of ferrous ion by this method, although the deviation was found between the measure value and the reference value. It needs more future work to clarify the mechanism of electrolytic oxidation and voltammetry applying in the mixture suspension samples.

Based on the calibration curve *c* that is described in Chapter 4, a linear relation was found between the weight percent of iron monosulfide and the concentration of sulfide ion, so that we can determine the FeS content from the measured amount of silver sulfide in the suspension. Because the sulfur species generated from the

electrolysis of iron disulfide can not be detected, the content of FeS in the mixture suspension samples was also evaluated from the measured concentration of sulfide ion after optimizing the voltammetry conditions. When the proposed technique was employed in mixture suspension samples, the measured values presented a good agreement with the reference values. Therefore, the FeS content in the mixture suspension can be evaluated on the basis of the concentration of sulfide ion.

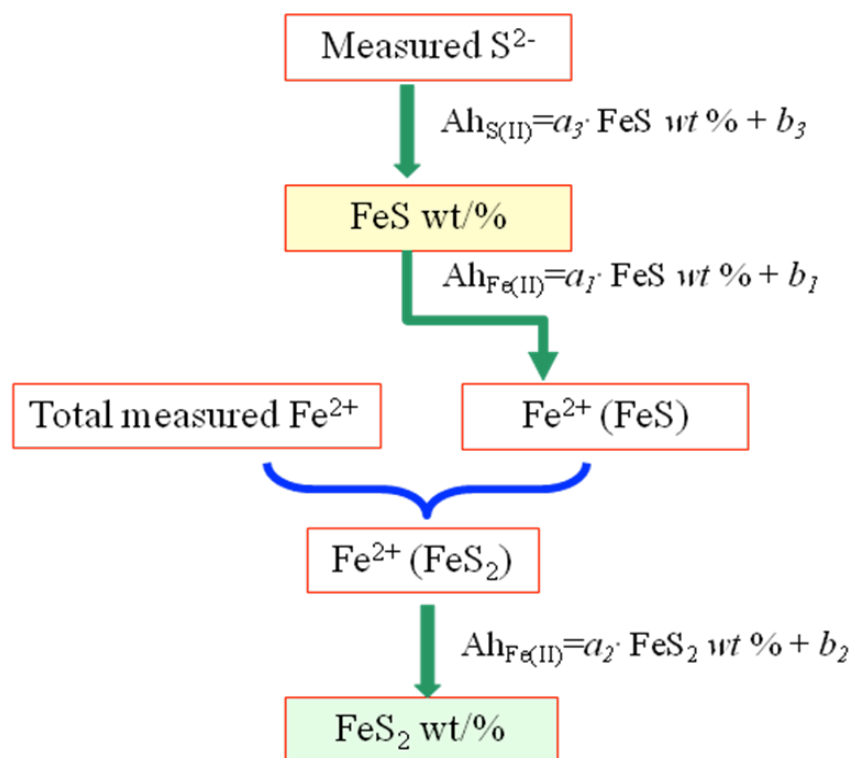


**Figure 6.1** Diagram of Determination of iron monosulfide content and iron disulfide content in the individually dispersed suspension samples.

In studying the possibility of determining the FeS and FeS<sub>2</sub> in the mixture suspension using linear sweep voltammetry by Pt-Ag twin electrode, we found that there was a good agreement of the measured FeS content calculated by the calibration curve *c* with the reference value established in Chapter 5.

We propose this method for measurement of iron sulfide content in the mixture suspension (see Figure 6.2). Traces of ferrous ion and sulfide ion were found in the mixture sample in the linear sweep voltammograms after the samples were oxidized on Pt electrode. The amounts of the ferrous ion and silver sulfide were obtained by calculating from the charge amounts of ferrous ion peak and silver sulfide peak. In this case, the three calibration curves were used to evaluate the contents of FeS and FeS<sub>2</sub> by the comparison of the measured values of ferrous ion and sulfide ion amounts with the reference values.

The concentrations of the silver sulfide were calculated from their peak charge; in this case, the calibration curve *c* was used to calculate the FeS content by the comparison of the measured values of silver sulfide amount with the reference values. Since the ferrous ion amount of FeS can be calculated using the calibration curve *a*, we can estimate the ferrous ion amount of FeS<sub>2</sub> by subtraction of the ferrous ion amount of FeS from the measured total ferrous ion amount. Then the FeS<sub>2</sub> content can be evaluated from the calibration curve *b*. However, there is a deviation between the measured FeS<sub>2</sub> content and the reference value in the mixture suspension samples because ferrous ion measurement in mixture system is so complicated that we can not determine all ferrous ion generated from both FeS and FeS<sub>2</sub>. Therefore, based on the three calibration curves, we can finally determine the FeS content and FeS<sub>2</sub> content in the individually dispersed suspensions, respectively, and determine only the FeS content in the mixture suspension samples.



**Figure 6.2** Diagram of Determination of iron monosulfide content and iron disulfide content in the mixture suspension samples.

The experimental results proved that it was practicable using Pt-Ag twin electrode cell to perform the whole determination of FeS and FeS<sub>2</sub> in the individually dispersed suspension and the determination of FeS in the mixture suspension. This is essentially useful to the achievement of on site measurement of FeS content in the environmental sludge by electrochemical method.

The results mentioned above gave valuable information for the design and construction of instrument for on site measurement of iron sulfide content in the sludge of bay and lake. We wish that this thesis contributes to the environmental monitoring and the protection of aquatic ecosystem.

## 6.2 Suggestions for Future Research



- An electrooxidation procedure is proposed at the first time for generation of electrochemically active species from solid iron sulfide, however, the mechanism of the electrolytic oxidation in the suspension is not clearly validated yet, which needs more experimental evidences.
- The sulfur species generated from the electrolysis of iron disulfide can not be detected by our proposed electrochemical method with Pt-Ag twin electrode, and we can not explain the reason exactly and needs to find the fact.
- There are some deviations of the results for the determination of FeS in the mixture suspension samples. In order to eliminate the deviations, more study should be made on how to improve the accuracy and sensitivity of the Pt-Ag twin electrode by modifying the structure of twin electrode and the procedure of electroanalysis.
- This methodology failed in the determination of FeS<sub>2</sub> in the mixture suspension samples due to the deviation of total ferrous ion measurement, so it may need another electrochemical method to measure the total concentration of ferrous ion in the mixture suspension sample. We have obtained this result from the previous work done by Lei YAN in our laboratory.
- After applying the proposed technique to the measurement of iron sulfide in the suspension samples, the next research has to be carried out on how to improve and utilize this electrochemical method to determine the iron sulfide from the natural sediments of sea and lake.

## REFERENCE AND NOTES

- [1] Dwight B. *Environ Sci Technol*, 1967, 1(8): 612-616.
- [2] Samuel J. *Environ Sci Technol*, 1970, 4(3): 204-209.
- [3] Miller S S. Debugging physical-chemical treatment. *Environ Sci Technol*, 1972, 6: 984-985.
- [4] van Beelen P, Doelman P. Significance and application of ... risks of contaminants in soil and sediment. *Chemosphere*, 1997, 34: 455-499.
- [5] Lau S SS, Chu L M. Contaminant Release from sediments in a coastal wetland. *Water Res*, 1999, 33: 909-918.
- [6] He M C, Wang Z J, Tang H X. Modeling the ecological impact of heavy metals on aquatic ecosystems: A framework for the development of an ecological model. *The Science of the Total Environment*, 2001, 266(1-3): 291-298.
- [7] Nendza M. Inventory of marine biotest methods for the evaluation of dredged material and sediments. *Chemosphere*, 2002, 48: 865-883.
- [8] Jøregensen B B. The sulfur cycle of freshwater sediments: Role of thiosulfate. *Limnol Oceanogr*, 1990, 35(6): 1329-1342.
- [9] Howarth R W, Stewart J W B, Ivano M V. *Sulfur Cycling on the Continents: Wetlands, Terrestrial Ecosystems and Associated Water Bodies*. Scope 48, Wiley, Chichester, 1992.
- [10] Asami H, Aida M, Watanabe K. Accelerated sulfur cycle in coastal marine sediment beneath areas of intensive shellfish aquaculture. *Applied and Environmental Microbiology*, 2005, 71(6): 2925-2933.
- [11] Moore J N, Ficklin W H, Johns C. Partitioning of arsenic and metals in reducing sulfidic sediments. *Environ Sci Technol*, 1988, 22: 432.
- [12] Tack F M, Lapauw F, Verloo M G. Determination and fractionation of sulphur in a contaminated dredged sediment. *Talanta*, 1997, 44: 2185-2192.
- [13] Pu X Q, Zhong S J. Sulfur cycle in sediments of the chinese marginal seas during early diagenesis.
- [14] Howarth R W, Giblin A, Gale J, Peterson B J, Luther G W. Reduced sulfur

- compounds in the pore waters of a New England salt marsh. *Environmental Biogeochemistry and Ecological Bulletins*, 1983, 35: 135-152.
- [15] Giblin A E, Likens Gene E, White D, Howarth R W. Sulfur storage and alkalinity generation in New England lake sediments. *Limnology and Oceanography*, 1990, 35(4): 852-869.
- [16] Jørgensen B B. Mineralization of organic matter in the sea bed- the role of sulphate reduction. *Nature*, 1982, 296: 643-645.
- [17] Peterson B J, Howarth R W. Sulfur, carbon and nitrogen stable isotopic tracers of organic matter flow in the salt marsh estuaries of Sapelo Island, Georgia. *Limnology and Oceanography*, 1987, 32(6): 1195-1213.
- [18] Morse J W, Luther G W. Chemical influences on trace metal sulfide interactions in anoxic sediments. *Geochim. Cosmochim. Acta*, 1999, 63: 3373-3378.
- [19] Simpson S L, Rochford L, Birch G F. Geochemical influences on metal partitioning in contaminated estuarine sediments. *Mar Freshwater Res*, 2002, 53: 9-17.
- [20] Teasdale P R, Apte S C, Ford P W, Batley G E, Koehnken L. Geochemical cycling and speciation of copper in waters and sediments of Macquarie Harbour, western Tasmania. *Estuar Coast Shelf Sci*, 2003, 57: 475-487.
- [21] Seidel H, Wennrich R, Hoffmann P, Löser C. Effect of different types of elemental sulfur on bioleaching of heavy metals from contaminated sediments. *Chemosphere*, 2006, 62: 1444-1453.
- [22] Nriagu J O, Soon Y K. Distribution and isotopic composition of sulfur in lake sediments of northern Ontario. *Geochim Cosmochim Acta*, 1985, 49:823-834.
- [23] Jørgensen B B, Cohen Y. Solar Lake (Sinai). 5. The sulfur cycle of the benthic cyanobacterial mats. *Limnol Oceanogr*, 1977, 22: 657-666.
- [24] Jørgensen B B. The sulfur cycle of freshwater sediments: Role of thiosulfate. *Limnol Oceanogr*, 1990, 35(6): 1329-1342.
- [25] Henrichs S M, Reeburgh W S. Anaerobic mineralization of marine sediment organic matter: rates and the role of anaerobic processes in the oceanic carbon economy. *Geomicrobiology Journal*, 1987, 5: 191-238.

- [26] Canfield D E, Jørgensen B B, Fossing H, Glud R N, Gundersen J, Ramsing N B, Thamdrup B, Hansen J W, Nielsen L P, Hall P O J. Pathways of organic carbon oxidation in three continental margin sediments. *Marine Geology*, 1993, 113: 27-40.
- [27] Thamdrup B, Canfield D E. Pathways of carbon oxidation in continental margin sediments off central Chile. *Limnology and Oceanography*, 1996, 41: 1629-1650.
- [28] Kostka J E, Thamdrup B, Glud R N, Canfield D E. Rates and pathways of carbon oxidation in permanently cold Arctic sediments. *Marine Ecology Progress Series*, 1999, 180: 7-21.
- [29] Rickard D T. Kinetics of FeS precipitation: Part 1. Competing reaction mechanisms. *Geochimica et Cosmochimica Acta*, 1995, 59: 4367-4379.
- [30] Berner R A. Sedimentary pyrite formation. *American Journal of Science*, 1970, 268: 1-23.
- [31] Luther III G W. Pyrite synthesis via polysulfide compounds. *Geochim Cosmochim Acta*, 1991, 55: 2839-2849.
- [32] Rickard D T. Kinetics of pyrite formation by the H<sub>2</sub>S oxidation of iron (II) monosulfide in aqueous solutions between 25 and 125°C: the mechanism. *Geochimica et Cosmochimica Acta*, 1997, 61: 135-147.
- [33] Berner R A. Burial of organic carbon and pyrite sulfur in the modern ocean: its geochemical and environmental significance. *American Journal of Science*, 1982, 282: 451-473.
- [34] Berner R A, Raiswell R. Burial of organic carbon and pyrite sulfur in sediments over Phanerozoic time: a new theory. *Geochimica et Cosmochimica Acta*, 1983, 47: 855-862.
- [35] Bagarinao T. Sulfide as an environmental factor and toxicant: tolerance and adaptations in aquatic organisms. *Aquatic Toxicology*, 1992, 24: 21-62.
- [36] Jørgensen B B. The sulfur cycle of a coastal marine sediment (Limfjorden, Denmark). *Limnology and Oceanography*, 1977, 22: 814-832.
- [37] Passier H, Middelburg J J, De Lange G J, Böttcher M E. Modes of sapropel

- formation in the eastern Mediterranean: some constraints based on pyrite properties. *Marine Geology*, 1999, 153: 199-219.
- [38] Fossing H, Jørgensen B B. Oxidation and reduction of radiolabeled inorganic sulfur compounds in an estuarine sediment, Kysing Fjord, Denmark. *Geochimica et Cosmochimica Acta*, 1990, 54: 27-42.
- [39] Zhang J Z, Millero F J. The products from the oxidation of H<sub>2</sub>S in seawater. *Geochimica et Cosmochimica Acta*, 1993, 57:1705-1718.
- [40] Sinninghe D J, De Leeuw J W. Analysis, structure and geochemical significance of organically-bound sulphur in the geosphere: state of the art and future research. *Organic Geochemistry*, 1990, 16: 1077-1101.
- [41] Berner R A, Westrich J T. Bioturbation and the early diagenesis of carbon and sulfur. *American Journal of Science*, 1985, 285: 193-206.
- [42] Aller R C, Rude P D. Complete oxidation of solid phase sulfides by manganese and bacteria in anoxic marine sediments. *Geochimica et Cosmochimica Acta*, 1988, 52: 751-765.
- [43] Aller R C. Benthic fauna and biogeochemical processes in marine sediments: the role of burrow structures. In: Blackburn T H (Ed.), *Nitrogen Cycling in Coastal Marine Environments*. Wiley, Chichester, 1988. pp. 301-338.
- [44] Fenchel T. The ecology of marine microbenthos. 4. Structure and function of the benthic ecosystem, its chemical and physical factors and the microfauna communities with special reference to the ciliated protozoa. *Ophelia*, 1969, 6: 1-182.
- [45] Goldhaber M B, Kaplan I R. The sulfur cycle. In: Goldberg E D, *The sea*. Wiley. 1974. pp. 569-655.
- [46] Kaplan I R, Emery K O, Rittenberg S C. The distribution and isotopic abundance of sulfur in recent marine sediments off southern California *Geochim Cosmochim Acta*, 1963, 27: 297-331.
- [47] Hartmann M, Nielsen H.  $\delta^{34}\text{S}$ -Werte in rezenten Meeressedimenten und ihre Deutung am Beispiel ciniger Sedimentprofile aus der we&lichen Ostsee. *Geol Rundschau*, 1969, 58: 621-655.

- [48] Berner R A. An idealized model of dissolved sulfate distribution in recent sediments. *Geochim Cosmochim Acta*, 1964, 28: 1497-1503.
- [49] Berner R A. *Principles of chemical sedimentology*. McGraw-Hill, 1971.
- [50] Morse J W, Cornwell J C. Analysis and distribution of iron sulfide minerals in recent anoxic marine sediments. *Mar Chem*, 1987, 22: 55-69.
- [51] Allen H E, Fu G, Deng B. Analysis of acid-volatile sulfide (AVS) and simultaneously extracted metals (SEM) for estimation of potential toxicity in sediment. *Environ Toxicol Chem*, 1993, 12: 1441-1453.
- [52] Hsieh Y P, Chung S W, Tsau Y J, Sue C T. Analysis of sulfides in the presence of ferric minerals by diffusion methods. *Chem Geol*, 2002, 182:195-201.
- [53] Duan W M, Coleman M L, Pye K. Determination of reduced sulphur species in sediments an evaluation and modified technique. *Chemical Geology*, 1997, 141: 185-194
- [54] Morse J W, Rickard D. Chemical dynamics of sedimentary acid volatile sulfide. *Environ Sci Technol*, 2004, 38: 131-136.
- [55] Morse J W, Arakaki T. Adsorption and coprecipitation of divalent metals with mackinawite (FeS). *Geochim Cosmochim Acta*, 1993, 57: 3635-3640.
- [56] Chapman P M, Wang F, Janssen C, Persoone G, Allen H E. Ecotoxicity of metals in aquatic sediments: binding and release, bioavailability, risk assessment, and remediation. *Can J Fisher Aquat Sci*, 1998, 55: 2221-2243.
- [57] Burton E D, Phillips I R, Hawker D W. Reactive sulfide relationships with trace metal extractability in sediments from southern Moreton Bay, Australia. *Mar Pollut Bull*, 2005, 50: 589-608.
- [58] Burton E D, Bush R T, Sullivan L A. Fractionation and extractability of sulfur, iron and trace elements in sulfidic sediments. *Chemosphere*, 2006, 64: 1421-1428.
- [59] Davies-Colley R J, Nelson P O, Williamson K J. Sulfide control of cadmium and copper concentrations in anaerobic estuarine sediments. *Mar Chem*, 1985, 16: 173-186.
- [60] Di Tore D M, Mahony J D, Hansen D J, Scott K J, Hicks M B, Mayr S M,

- Redmond M S. Toxicity of cadmium in sediments: the role of acid volatile sulfide. *Environ Toxicol Chem*, 1990, 9: 1487-1502.
- [61] Di Toro D M, Mahony J D, Hansen D J, Scott K J, Carlson A R, Ankley G T. Acid volatile sulfide predicts the acute toxicity of cadmium and nickel in sediments. *Environ Sci Technol*, 1992, 26: 96-101.
- [62] Casas A M, Crecelius E A. Relationship between acid volatile sulfide and the toxicity of lead, zinc, and copper in marine sediments. *Environ. Toxicol Chem*, 1994, 13: 529-536.
- [63] Rickard D, Morse J W. Acid volatile sulfide: Authors' closing comments. *Marine Chemistry*, 2005, 97: 213-215.
- [64] Berner R A. Sulfate reduction, pyrite formation, and the oceanic sulfur budget. In: Dryssen D, Jayner D (Eds.), *The Changing Chemistry of the Oceans*. New York: Wiley, 1972. pp. 347-361.
- [65] Berner R A. Thermodynamic stability of sedimentary iron sulfide. *Am J Sci*, 1967, 265: 773-785.
- [66] Banica F G, Fogg A G, Moreira J C. Catalytic cathodic stripping voltammetry at a hanging mercury drop electrode of glutathione in the presence of nickel ion. *Analyst*, 1994, 119:2343.
- [67] Heyrovsky M, Vavricka S. Electrochemical reactivity of homocysteine at mercury electrode as compared with cysteine. *Bioelectrochem. Bioenerg*, 1999, 48:43.
- [68] Owens G S, LaCourse W R. Pulsed electrochemical detection of sulfur-containing compounds following microbore liquid chromatography. *Current Sep*, 1996, 14:82.
- [69] Osteryoung J G, Osteryoung R A. Square Wave Voltammetry. *Anal Chem*, 1985, 57:101-110.
- [70] Wang J. Anode Stripping Voltammetry as an Analytical Tool. *Environ Sci Tech*, 1982, 16: 104-109.
- [71] Wang J. Anodic stripping voltammetry at graphite-epoxy microelectrodes for in

- vitro and in vivo measurements of trace metals. *Anal Chem*, 1982, 54: 221-223.
- [72] Bard A J, Faulkner L R. *Electrochemical Methods, Fundamentals and Applications*; John Wiley: New York, 1980.
- [73] Christensen C R, Anson F C J. Chronopotentiometry in thin layer of solution. *Anal Chem*, 1963, 35: 205-209.
- [74] Hubbard A T, Anson F C, in *Electroanalytical Chemistry, Vol. 4* (Bard A J, ed.), Marcel Dekker, New York, 1970, pp. 129-214
- [75] Huerta-Diaz M A, Tessier A, Carignan R. Geochemistry of trace metals associated with reduced sulfur in freshwater sediments. *Appl Geochem*, 1998, 13: 213-233.
- [76] Boules K C, Ernste M J, Kramer J R. Trace sulfide determination in oxic freshwaters. *Anal Chim Acta*, 2003, 477: 113-124.
- [77] Lasorsa B, Casas A. A comparison of sample handling and analytical methods for determination of acid volatile sulfides in sediment. *Mar Chem*, 1996, 52: 211-220.
- [78] Henneke E, Lutter G W, Lange G J. Determination of inorganic sulphur speciation with polarographic techniques: Some preliminary results for recent hypersaline anoxic sediments. *Mar Geol*, 1991, 100: 115-123.
- [79] Ugo P, Bertolin A, Moreto L M. Monitoring sulphur species and metal ions in salt-marsh pore-waters by using an in-situ sampler. *Int J Environ Anal Chem*, 1999, 73: 129-143.
- [80] Madureira M J, Vale C, Simões Gonçalves M L. Effect of plants on sulphur geochemistry in the Tagus salt-marshes sediments. *Mar Chem*, 1997, 58: 277-234.
- [81] von Wandruszka R, Yuan X, Morra M J. Determination of sulfur species by cathodic square wave stripping voltammetry; Compounds relevant to natural sulfur mineralization. *Talanta*, 1993, 40: 37-42.
- [82] Serafim D M, Stradiotto N R. Determination of sulfur compounds in gasoline using mercury film electrode by square wave voltammetry. *Fuel*, 2008, 87: 1007-1013.



- [83] Zehnder A J B, Zinder S H. Handbook of Environmental Chemistry, Vol. 1, part A: The Natural Environment and the Biogeochemical Cycles, Springer-Verlag, Berlin, 1980.
- [84] Canfield D E. Reactive iron in marine sediments. *Geochim Cosmochim Acta*, 1989, 53: 619-623.
- [85] Berner R A. Sedimentary pyrite formation: an update. *Geochim Cosmochim Acta*, 1984, 48: 605-613.
- [86] Förstner U. *Biogedynamics of Pollutants in Soils and Sediments*, Springer, Berlin, 1995.
- [87] Leonard E N, Mattson V R, Benoit D A, Hoke R A, Ankley G T. Seasonal variation of acid volatile sulfide concentration in sediment cores from three northeastern Minnesota lakes. *Hydrobiologia*, 1993, 271: 87-95.
- [88] Weston R S. INDUSTRIAL WASTES Water Pollution. *Ind Eng Chem*, 1939, 31(11): 1311-1315.
- [89] Davison W, Lishman J P. Rapid colorimetric procedure for the determination of acid volatile sulphide in sediments. *Analyst*, 1983, 108: 1235-1239.
- [90] Giani L, Eden L, Gebhardt H. Sulfidbestimmung in Böden und Sedimenten. *Z Pflanzenernähr Bodenk*, 1986, 149: 354-356.
- [91] Cutter G A, Oatts T J. Determination of dissolved sulfide and ... using gas chromatography-photoionization detection. *Anal Chem*, 1987, 59: 717-721.

## LIST OF PUBLICATION AND PRESENTATION

### ----- Publication -----

**Xiao-jun Diao**, Katsuhiko Sumi. Determination of iron monosulfide and iron disulfide in suspensions by electrochemical method using platinum-silver twin-electrode. Anal. Sci. (submitted)

### ----- Presentation -----

**Xiao-jun Diao**, Katsuhiko Sumi, “Determination of FeS and FeS<sub>2</sub> contents in the suspension with Pt-Ag twin-electrode by electrochemical methods,” in the Analytical Research Forum 2009 of Royal Society of Chemistry, P05, Canterbury, English, July 13-15, 2009.

**Xiao-jun Diao**, Katsuhiko Sumi, “Determination of Iron amount and sulfur amount in the suspensions of FeS and FeS<sub>2</sub> after electrolytic oxidation with Pt-Ag twin-electrode,” in the 69th Discussion Conference of Japanese Analytical Chemistry, A2007, Nagoya, Japan, May 15-16, 2008.

**Xiao-jun Diao**, Katsuhiko Sumi, “Detection of iron amount and sulfur amount in the suspensions of FeS and FeS<sub>2</sub> after electrolytic oxidation with Pt-Ag twin-electrode,” in the 88th Spring Conference of Japanese Chemistry, 1L1-45, Tokyo, Japan, March 26-30, 2008.

**Xiao-jun Diao**, Katsuhiko Sumi, “Detection of iron and sulfur after electrochemical oxidation with platinum-silver twin-electrode in FeS suspension by electrochemical methods,” in the 56th Conference of Japanese Analytical Chemistry, P3068, Tokushima, Japan, September 19-21, 2007.

## ACKNOWLEDGEMENT

The work of this thesis was performed under the guidance of Prof. K. Sumi. I would like to express my sincere gratitude to my advisor Prof. K. Sumi for his kind guidance, invaluable suggestions and continuous encouragement throughout this work.

I would also like to express my grateful acknowledgement to Prof. M. Hojo, Prof. K. Kobiro, Prof. T. Enomoto and Prof. T. Narusawa, for their valuable comments and suggestions.

I wish to express my appreciation to the members of our research laboratory, including Mr. Tamura, Mr. Nomura and Mr. Doi, for their collaboration and assistance in this work.

Sincere thanks are to Prof. M. Ban, Ms. M. Kubo, Ms. K. Kiyooka and Mr. M. Yoshida at IRC for their continuous assistance and concern. I also wish to thank them for their kindness and hearty to the foreign students. Furthermore, I wish to express my appreciation to all the Japanese and Chinese friends, for their hearty encouragement and assistance during my study in Japan.

I would like to express my special thanks to my family, especially my husband, for their love, understanding, support and encouragement.

In a word, I thank all the persons who have ever helped and supported me during the course of this study.