

2011

Doctorate thesis

**A Study of Input and Output
Haptic Modalities in Pen-based
User Interfaces: Vibration,
Texture and Hand Posture**

1126010 Minghui SUN

Advisor Xiangshi REN

March 2011

Course of Information Systems Engineering

Graduate School of Engineering, Kochi University of Technology

Abstract

A Study of Input and Output Haptic Modalities in Pen-based User Interfaces: Vibration, Texture and Hand Posture

Minghui SUN

This thesis investigates human performance in relation to different kinds of tactile feedback in pen-based interfaces, including active tactile feedback (vibration) and passive tactile feedback (texture), and proposes natural and seamless interaction techniques with the information of kinesthetic sense (hand posture).

With the development of technology, more and more digital devices, such as mobile phones, PDAs and wireless tablet PCs, are appearing in the market. Since natural and conventional input properties, pen is widely used together with those input devices for choosing target, writing and drawing. Traditionally users get feedback with graphical user interfaces (GUI) in pen-based interaction. GUI has long been used to communicate between humans and computers through the visual channel, i.e., “what you see is what you get”. As interaction tasks become more complex and intense, visual feedback as the sole channel is showing its limitations. The use of additional haptic feedback is potential solution to expand the bandwidth between human and computer. This thesis investigates how haptic feedback affects the human performance and how to use the properties of haptic sensation to assist human computer interaction.

Several experiments are presented. For efficient feedback in steering tasks, experiment 1 of Chapter 2 examines feedback presented in visual, auditory and haptic

modalities, both individually and in combinations. The results show that users performed most accurately with tactile feedback. And it was found that feedback type significantly affects the accuracy of steering tasks but not the movement time. For efficient feedback location in steering tasks, experiment 2 of Chapter 2 examines the feedback locations presented with inside of tunnel, at the boundary of tunnel and outside of tunnel. It was found that feedback location affects movement time significantly and outside of tunnel outperforms other two locations. Experiment 1 and 2 of Chapter 3 evaluates different human modalities for both 1D and 2D pointing tasks in tracking state separately. Results for both the 1D and 2D pointing tasks show that tactile plus suitable visual feedback can improve accuracy and audio is not efficient to give user feedback in tracking state. Experiment of Chapter 4 investigates the effects of different textures of input surface. It was found that different textures significantly affects the accuracy of steering tasks and pressure, but not the movement time. In Chapter 5, we also propose a number of natural interaction techniques with kinesthetic and angle information. All of these techniques effectively let users focus on their work but not tool selection.

This thesis will contribute to basic understanding the relationship between different human modalities and human performance in fundamental human computer interaction tasks. And this thesis also proposes several interaction techniques. All these results offer insights and implications for the future design of applying human modalities into input channel and feedback mechanisms of pen-based interfaces.

key words Human-computer interaction, human modality, human performance, interaction techniques, pointing task, steering task, haptics.

Contents

Chapter 1	Introduction	1
1.1	Research Motivation	1
1.2	Background Knowledge	2
1.2.1	Predictive Models of Human Performance	3
	Fitts' Law	3
	Steering Law	4
1.2.2	Haptic Modality	6
1.3	Dissertation Structure	8
1.4	Terminology	9
Chapter 2	Effects of Multimodal Error Feedback on Human Performance in Steering Tasks	13
2.1	Introduction	13
2.2	Related Work	17
2.2.1	Multimodal Feedback	17
2.2.2	Feedback Location	19
2.3	Pilot Study	21
2.4	Experiment 1: Multimodal Error Feedback	21
2.4.1	Participants	21
2.4.2	Apparatus	22
2.4.3	Task and Procedure	22
2.4.4	Design	24
2.4.5	Hypotheses	25
2.4.6	Results	26

Contents

	Movement Time (MT)	26
	Standard Deviation (SD)	27
	Out of Path Movement (OPM)	27
	Subjective Evaluation	28
	Steering Law Analysis	29
2.5	Experiment 2: Feedback Locations	30
2.5.1	Participants	30
2.5.2	Apparatus	30
2.5.3	Task and Procedure	30
2.5.4	Design	31
2.5.5	Results	32
	Movement Time (MT)	32
	Standard Deviation (SD)	33
	Out of Path Movement (OPM)	33
	Subjective Evaluation	35
2.6	Discussion	35
2.6.1	Multimodal Error Feedback	35
2.6.2	Feedback Location	38
 Chapter 3 A Comparison of Multimodal Feedback in Pointing Task		
with Tracking State		41
3.1	Introduction	41
3.2	Related Work	43
3.2.1	Tracking State	43
3.2.2	Effects of Multimodal feedback	43
3.3	Pilot Study	44

Contents

3.4	Experiment 1: 1D Pointing Task	46
3.4.1	Participants	46
3.4.2	Apparatus	46
3.4.3	Task and Procedure	47
3.4.4	Design	48
3.4.5	Hypotheses	49
3.4.6	Results	50
	Movement Time (MT)	50
	Error Rate	50
	Subjective Evaluation	51
3.5	Experiment 2: 2D Pointing Task	52
3.5.1	Participants	52
3.5.2	Apparatus	52
3.5.3	Task and Procedure	52
3.5.4	Design	54
3.5.5	Hypotheses	55
3.5.6	Results	56
	Movement Time (MT)	56
	Error Rate	58
	Subjective Evaluation	58
3.6	Discussion	59
 Chapter 4 An Investigation of the Relationship between Texture and		
Human Performance in Steering Tasks		65
4.1	Introduction	65
4.2	Related Work	66

Contents

4.3	Experiment	67
4.3.1	Participants	67
4.3.2	Apparatus	67
	Measurement of Coefficients of Friction	68
	Subjective Evaluation before the Experiment	69
4.3.3	Task and Procedure	70
4.3.4	Design	70
4.3.5	Hypotheses	71
4.3.6	Results	71
	Movement Time (MT)	72
	Error Rate	72
	Pressure	73
	Steering Law Analysis	74
	Subjective Evaluation	75
4.4	Discussion	75
 Chapter 5 Interaction Techniques with Personal User Input Modalities for Natural Pen-based Interfaces		79
5.1	Introduction	79
5.2	Related work	81
5.2.1	Additional Input Channels on Stylus	81
5.2.2	Input Modalities on Input Panel (Canvas)	82
5.3	Interview Investigation	83
5.4	Interaction Techniques	84
	Applications of Tool Selection	85
	Background Selection	87

Contents

5.5	System Implementation	89
	Apparatus	89
	Grip Recognition	90
5.6	Discussion	90
Chapter 6 General Conclusions and Contributions		93
6.1	Effects of Multimodal Error Feedback on Human Performance in Steering Tasks	94
6.2	A Comparison of Multimodal Feedback in Pointing Task with Tracking State	94
6.3	An Investigation of the Relationship between Texture and Human Per- formance in Steering Tasks	95
6.4	Interaction Techniques with Personal User Input Modalities for Natural Pen-based Interfaces	96
Acknowledgement		97
References		99
Appendix A Publications		110
A.1	Articles in or submitted refereed journals	110
A.2	Articles in full paper refereed international conference proceedings . . .	110
A.3	Articles in abstract refereed international conference proceedings	111
A.4	Articles in refereed local conference proceedings	111

List of Figures

- 1.1 Samples of pen-based devices. (All pictures are downloaded from web sites) 1
- 1.2 Fitts' reciprocal pointing paradigm [27]. 3
- 1.3 Navigation in hierarchical menus [1]. 5
- 1.4 Steering tasks [1]. 5
- 1.5 Sharp letters of Chinese calligraphy. 6
- 1.6 Sensory homunculus drawn upon the profile of one hemisphere [65]. . . 7
- 1.7 The dissertation structure. 11

- 2.1 Stylus with an attached motor and the motor. 22
- 2.2 Experimental task. 23
- 2.3 Mean MT by different feedback types (with standard error bars). . . . 26
- 2.4 Mean SD with different feedback types. 27
- 2.5 Mean OPM with different feedback types. 28
- 2.6 Experiment environment. 31
- 2.7 Mean Movement time with different feedback positions. 33
- 2.8 Mean SD with different feedback positions. 34
- 2.9 Mean OPM with different feedback positions. 34
- 2.10 Subjective evaluation with different feedback positions. 35

- 3.1 Pen Operation States. 42
- 3.2 (a) Motorized Pen; (b) Motorized Belt. 45
- 3.3 Indirect input (left); direct input (right). 47
- 3.4 The Process of 1D pointing task in tracking state. 48

List of Figures

3.5	Mean MT by different feedback types with direct input device in 1D pointing tasks (Error bars represent 95% confidence interval).	51
3.6	Mean MT by different feedback types with indirect input device in 1D pointing tasks (Error bars represent 95% confidence interval).	52
3.7	Error rate by different feedback types with direct input device in 1D pointing tasks.	53
3.8	Error rate by different feedback types with indirect input device in 1D pointing tasks.	54
3.9	Subjective evaluation in 1D pointing tasks.	55
3.10	The 2D pointing tasks.	56
3.11	The Process of 2D pointing task in tracking state.	57
3.12	Mean MT by different feedback type with direct input device in 2D pointing tasks. (Error bars represent 95% confidence interval)	57
3.13	Mean MT by different feedback type with indirect input device in 2D pointing tasks. (Error bars represent 95% confidence interval)	58
3.14	Error rate by different feedback types with direct input device in 2D pointing tasks.	59
3.15	Error rate by different feedback types with indirect input device in 2D pointing tasks.	60
3.16	Subjective evaluation in 2D pointing tasks.	61
4.1	(a) Paper. (b) Hard cover. (c) Soft plastic. (d) Plastic. (e) Tablet.	68
4.2	Mean MT by different material types (Error bars represent 95% confidence interval).	72
4.3	Mean <i>SD</i> by different material types (Error bars represent 95% confidence interval).	73

List of Figures

4.4	Mean pressure by different material types (Error bars represent 95% confidence interval).	74
4.5	Subjective evaluation of ease-of-use and accuracy.	75
5.1	The interview of oil painting.	83
5.2	Four easel angles.	84
5.3	State transitions of interaction techniques.	85
5.4	Sketch pencil grip.	86
5.5	Pen grip.	86
5.6	Chinese calligraphy grip.	87
5.7	Compass grip.	87
5.8	Airbrush grip.	88
5.9	Eraser grip.	88
5.10	Multi-touch pen hardware.	89

List of Tables

- 2.1 Steering law models with different feedback 29

- 3.1 The results of two experiments. (Y means there is a significant effect on variable; N means there is no significant effect on variable.) 60

- 4.1 The coefficients of dynamic friction 69

- 4.2 Steering Law regression values for material types. 74

Chapter 1

Introduction

1.1 Research Motivation

Human computer interaction (HCI) is the study of how people and computers communicate with each other. It intertwines with computer science, psychology, statistics, design and other research fields. Both input and output are the research topics. With the advances in hardware techniques, pen-based input devices are becoming more and more popular. People start to use pen when they are very young. Pen-paper metaphor becomes a natural way for people to communicate with each other, assist to think and draw. Due to the natural and convenient properties, most of the ubiquitous devices, like PDAs, Tablet PCs, cell phones (see Fig.1.1), use digital pen as input device.

The current pen-based interface has relied on Graphic user interface (GUI) for a long time. However, pen-based interface design has become increasingly challenging by the increase of information, different workload, security and physical limitations. In many scenarios, interaction with visual interface creates competition for different



Fig. 1.1 Samples of pen-based devices. (All pictures are downloaded from web sites)

1.2 Background Knowledge

environments and different people. For example, dark environment are difficult to verify the operation, especially for the old and visual impaired users. In subway and train scenario, the unstable screen limits the visual feedback and audio feedback would not be heard. Even in normal life and stable scenario, visual feedback from small screen of mobile devices may increase the workload of input and tactile feedback can improve the drawback of virtual buttons which are lack of tactile feedback. For virtual buttons, there is no tactile feedback available and it affects users' abilities and forces them to get information only from visual feedback. Hoggan et al. [40] designed an experiment to investigate the effectiveness of tactile feedback for mobile touch-screens. Results showed that tactile feedback improved user performance significantly with virtual buttons on touchscreen mobile devices.

With the development of haptic technology, many tactile technologies have been applied into Virtual Reality, medical training, remote control, flight simulation and other application fields. However, there has been little study to investigate human modalities in pen-based interfaces. Thus there is a strong motivation for comprehension of different human modalities in pen-based interface and designing natural and seamless interaction techniques with properties of haptic modality.

1.2 Background Knowledge

Several previous literatures related to my thesis are reviewed in this part. We first introduce the models of human performance in Human Computer Interaction (HCI). Both Fitts' law and Steering law are presented. These two laws are the fundamental theories in HCI. And then we present an overview of haptic sensation in psychology and applications in HCI briefly. We will also give the introduction in the related work subsection in each of chapters.

1.2 Background Knowledge

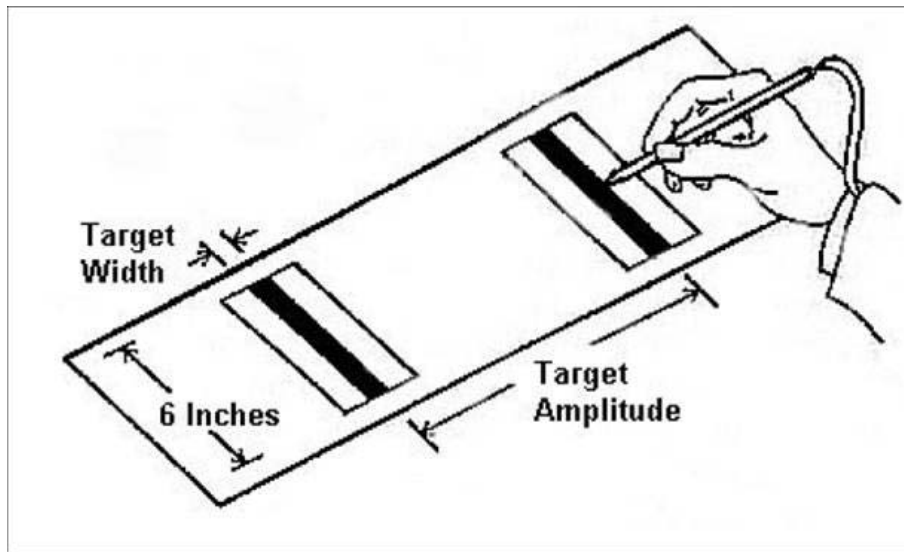

Fig. 1.2 Fitts' reciprocal pointing paradigm [27].

1.2.1 Predictive Models of Human Performance

Fitts' Law

Fitts' law, developed by Fitts [27], provides a model to predict human performance when users interact with computers: how long user can point at a target? He designed 1D reciprocal pointing task (see Fig.1.2). Two targets with suitable height, width and amplitude were shown to subjects. The subjects used a pen to tap two targets back and forth on a platform. According to the experiment results, Fitts' law revealed a relationship between movement time and experimental variables. The movement time MT to move the hand and point to a target of width W at a distance A is:

$$MT = a + b \log_2\left(\frac{A}{W} + 1\right) \quad (1.1)$$

Where a and b are empirically determined constants. And the index of difficulty (ID) is:

$$ID = \log_2\left(\frac{A}{W} + 1\right) \quad (1.2)$$

1.2 Background Knowledge

To evaluate the information capacity of various limbs, different input devices and other environments, the index of performance (IP) is proposed.

$$IP = \frac{1}{b} \quad (1.3)$$

The linear speed-accuracy relationship revealed by Fitts' law has been applied in many research areas, like psychology, HCI and kinematics. Fitts' law, one of the very few useful and quantitative laws, is also be used to evaluate input devices [14, 25, 48]. This law helps designer to understand and evaluate the capacity and performance of system and human being. It contributes to design natural and efficient human computer interfaces.

Steering Law

Trajectory-based tasks (also known as steering tasks) stand for a set of human actions in HCI, such as navigation in hierarchical menus (see Fig.1.3), drawing and writing. The goal of trajectory-based tasks (see Fig.1.4) is to navigate from one end of the tunnel to the other one as quickly as possible. In steering tasks, the width of tunnel is the constraint of movement. Users should try their best to avoid touch the boundary of the tunnel. In calligraphy practice, tracing paper with standard sharp letter is used. The sharp letter (see Fig.1.5) is a kind of tunnel. Children are taught how to control the calligraphy to write beautiful characters while they should avoid writing out of the sharp letters. We can easily know that steering task also obeys speed-accuracy tradeoff as the same as the pointing task. The faster we move the stylus, the less precise the trajectory is, and vice versa.

Johnny Accot and Shumin Zhai [1] designed experiments to model the steering task based on the Fitts' law. Firstly they identified that goal passing task also obeyed the

1.2 Background Knowledge

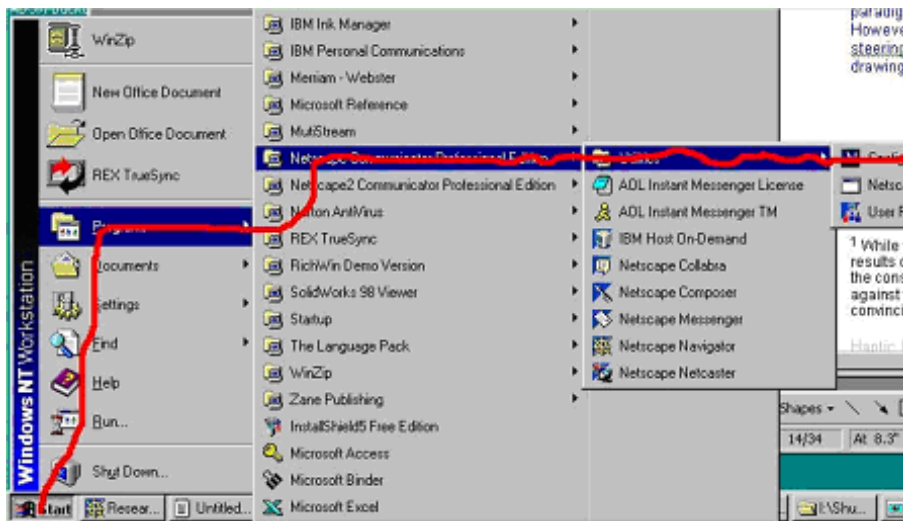

Fig. 1.3 Navigation in hierarchical menus [1].

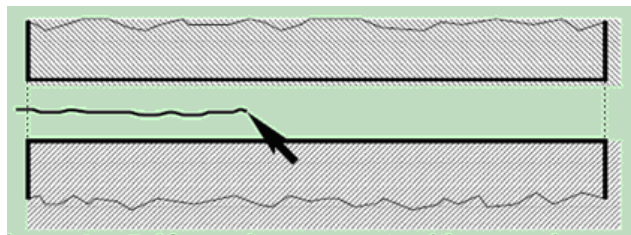

Fig. 1.4 Steering tasks [1].

Fitts' law, despite the different nature of movement constraint. And then they defined a recursion with goal passing tasks. The amplitude A of steering task can be divided into N parts of goal passing tasks. When N becomes bigger, subject has to be careful to pass through all goals without touching the boundaries. The ID of goal passing task is:

$$ID(n) = N \log_2 \left(\frac{A}{NW} + 1 \right) \quad (1.4)$$

If N tends to infinity, it becomes a steering task. And the ID changes to:

$$ID_{\infty} = \frac{A}{W \ln 2} \quad (1.5)$$

1.2 Background Knowledge

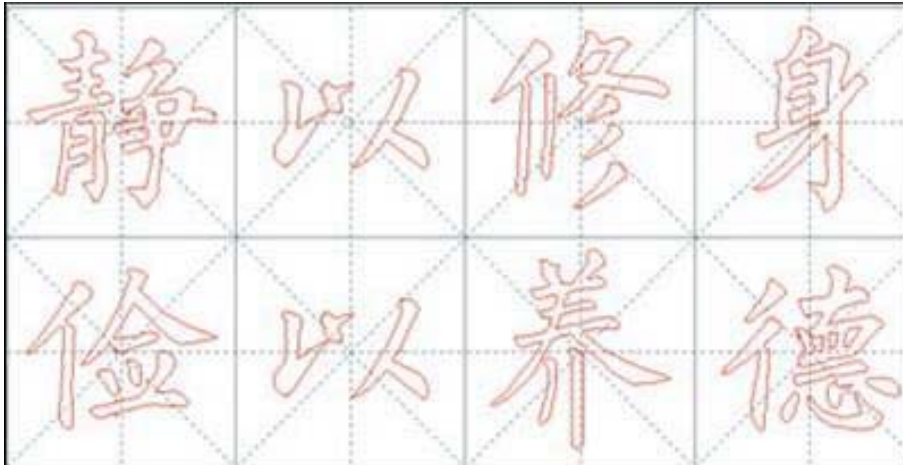

Fig. 1.5 Sharp letters of Chinese calligraphy.

Finally the equation reduces to

$$MT = a + b \frac{A}{W} \quad (1.6)$$

Where A is the length of the tunnel and W is the width of the tunnel. The movement time in steering task is linearly related to the amplitude of the tunnel and inverse related to the width of the tunnel. The steering law gives another theory foundation for device comparison and interface design in HCI.

1.2.2 Haptic Modality

Human beings communicate with the world through five sensory modalities, visual, auditory, haptic, taste, and smell. Haptics, which is the earliest sense to develop in the human embryo [65], is a term derived from the Greek verb “haptesthai” means “of or relating to the sense of touch”. Haptic modality has several unique properties in human modalities: Every part of skin can receive haptic feedback. The largest organ system of body is the skin which is about $2,500 \text{ cm}^2$ in the newborn and $18,000 \text{ cm}^2$ in the average male. All the cortical areas (see Fig. 1.6) are intuitive receptors in the skin.

Haptic modality is both input and out channel between human and the world.

1.2 Background Knowledge

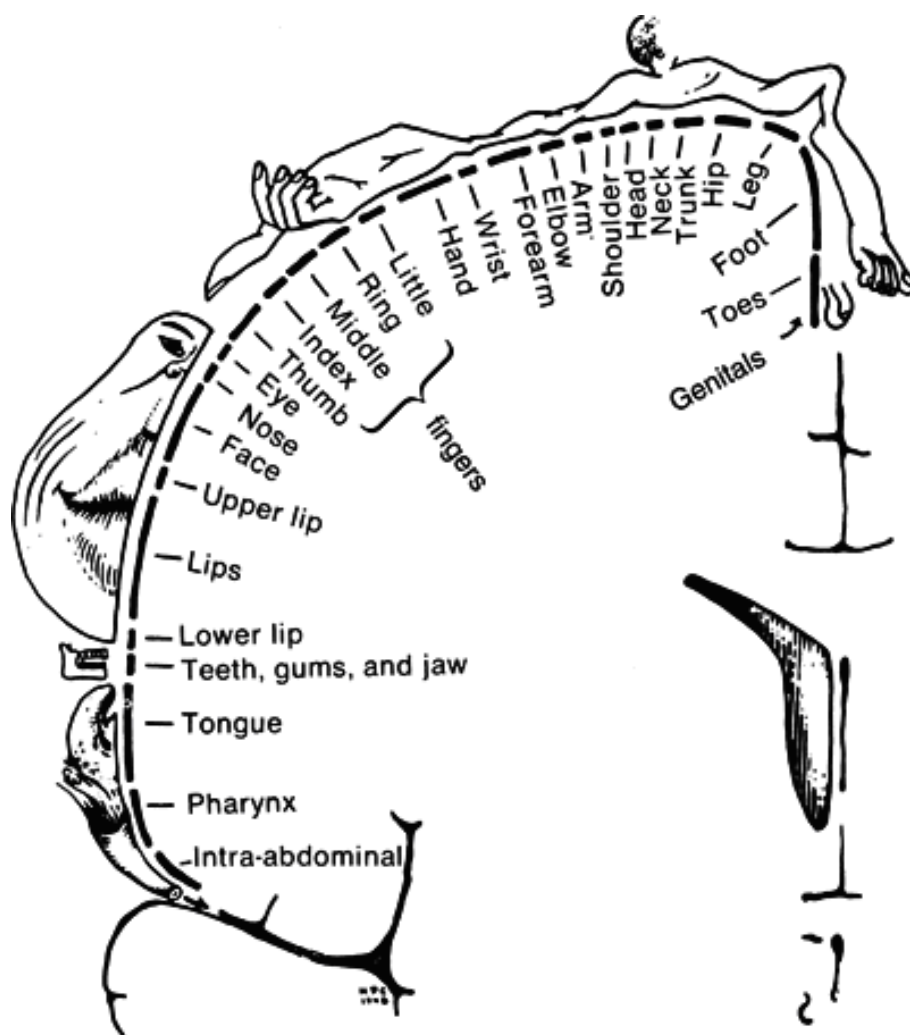

Fig. 1.6 Sensory homunculus drawn upon the profile of one hemisphere [65].

The single most important feature of the haptic interaction modality is bidirectionality. Except haptics, all sensory modalities are input channel. The haptic information can be transferred between human and computer in the background when user controls the computer. Haptic sensation is comprised of tactile sensations and kinesthetic sensations. Tactile sensations include pressure, texture, puncture, thermal properties, softness, wetness, vibrotactile parameters; kinesthetic sensations include awareness of one's body state, position, velocity, forces supplied by muscles. As described by Klatzky and Lederman [50], the tactile systems receptors embedded in the skin while the kines-

1.3 Dissertation Structure

thetic system employs receptors located in muscles, tendons, and joints.

Haptics techniques have been applied into several fields including virtual reality, surgical simulation, augmented reality, visualization and data perceptualization.

There are several researches showed feasibility of tactile composition. Lee et al. [53] designed a tactile stylus to simulate several different statuses. The tactile feedback from this haptic pen enhanced interaction with GUI and help to make system more accessible to visual and motor impairments. Kaaresoja et al. [46] applied tactile feedback into the mobile devices with touch screen. In four different applications, the tactile feedback all improved user performance. Nashel [67] also presented tactile feedback to virtual buttons on mobile devices with touch screen. In studies [71–73], Poupyrev et al. amounted piezo actuators on the touch screen and resistive touch panel.

1.3 Dissertation Structure

The structure of this dissertation is shown in Fig.1.7. The rest of this thesis is organized as follows: In chapter 2, we investigate the relationship between “error feedback” (when tracking or trajectory errors are made) and user performance in steering tasks. The experiment examines feedback presented in visual, auditory and tactile modalities, both individually and in combinations. This chapter contributes to the basic understanding of “error feedback” and how it impacts on steering tasks, and it offers insights and implications for the future design of multimodal feedback mechanisms for steering tasks.

Pointing task is the other fundamental task in HCI. The time during users click target with pen is very short and the click also supplies tactile feedback to confirm this action. However, pointing task in tracking state is difficult for users to detect with default visual feedback. In chapter 3, we report on two experiments which are designed

1.4 Terminology

to evaluate multimodal feedback for pointing tasks (both 1D and 2D) in tracking state. This part proposes several guidelines for feedback design in tracking state. We believe these results can aid designers of pen-based interfaces in tracking state.

Both chapter 2 and chapter 3 explore the haptic feedback (vibration) on pen. There is another part of input device in pen-based interfaces - tablet. There is little study about the effect of surface environment especially for the texture of interaction surface. In chapter 4, we experimentally investigate the users' performances with the change of surface textures in steering tasks. Five different materials in the real world are used to supply different textures. Several possible factors of friction are considered in this study.

Haptics is not only the input modality but also the output modality. In chapter 5, we will use the properties of kinesthetic sensation to naturally and seamlessly improve pen-based interfaces. Several interaction techniques will be designed according to different hand postures (grasp).

1.4 Terminology

Haptic: Relating to the sense of touch which is one of five modalities of human being.

Haptics: Concerns the actions and manipulations of targets using the sense of touch, it includes tactile sense and kinesthetic sense.

Perception: Awareness of environment and objects of environment through physical sensation.

Kinesthetic: Relating to the ability to sense body position and the movement of muscles, tendons and joints.

Texture: In this thesis, we use the term texture to refer to the fine structure of a

1.4 Terminology

surface (microstructure), and as independent of the shape (macrostructure) of an object or surface.

Multimodal Feedback: The feedback combined various the modalities of people, for example, speech recognition, gaze, body movements, gesture and so on.

Multitouch Pen or MTpen: It is an input device with a capacitive sensor around the digital pen and was designed by Microsoft Research. With this device, the positions of fingers can be detected with sensors.

Hand Posture: means the postures how user holds or grasps the pen. User can know the hand postures with the kinesthetic information.

Interaction technique: is a combination of hardware and software design to provide user a good solution to accomplish a task.

1.4 Terminology

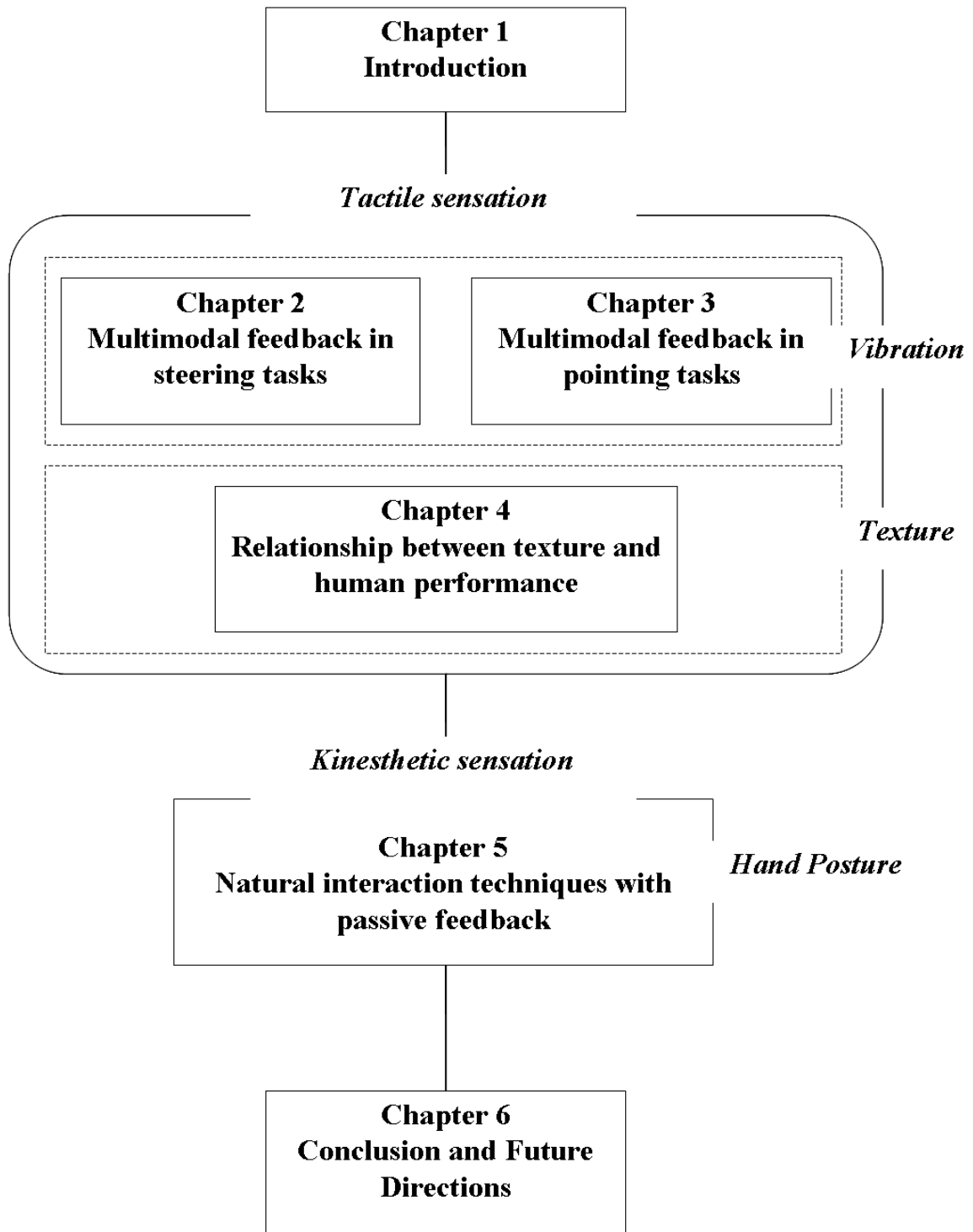

Fig. 1.7 The dissertation structure.

1.4 Terminology

This is a blank page.

Chapter 2

Effects of Multimodal Error Feedback on Human Performance in Steering Tasks

2.1 Introduction

Graphical user interfaces (GUI) have long been used to communicate between humans and computers through the visual channel, i.e., “what you see is what you get”. As interaction tasks become more complex and intense, visual feedback as the sole channel is showing its limitations. It is necessary to study user performance under different modalities both individually and in combinations. Several classes of fundamental tasks exist, such as pointing, crossing [3], and steering. Burke et al. [11] mentioned that the effect of sensory channel feedback was likely to vary across different tasks. Many researchers [4] [5] [44] [45] have compared the effects of different modalities of feedback on user performance in pointing tasks and crossing tasks. However, little study has been done on steering tasks. The term “steering task” stands for a set of human actions in HCI, for example, navigation in hierarchical menus, drawing, writing, etc. With pen-based interaction becoming increasingly popular, the steering task has also become a common task in daily human-computer interaction, and is thus worthy of further investigation.

2.1 Introduction

Another reason we chose the steering task is we are interested in feedback that continuously alerts users to errors and prompts them to make corrections on the fly; discrete tasks such as pointing and crossing are not as suitable. Trajectory-based tasks (also known as steering tasks) [1], such as navigating through a tunnel or tracing a picture, require continuous adjustment along the trajectory and are thereby appropriate for our purpose. In standard steering tasks such as those performed with a stylus, the user traces a path through a visual tunnel, and is required to keep the stylus within the tunnel at all times. Therefore, we conducted a controlled experiment to study the effects of multimodal feedback on human performance in steering tasks.

Although two papers [16] [21] present studies on steering tasks, they only used “affirmative” feedback for guidance and affirmation. Affirmative feedback means feedback is given only when the cursor is moved inside the tunnel or area in which the user expects it to move. Affirmative feedback only reminds the user that the cursor (pen-tip) is in the correct area or direction. It has been shown to be beneficial especially for the older and/or visually impaired population as it confirms that they are on the right track. For example, when a pedestrian light turns green, a sound starts and changes over time. The blind can be guided to cross the road with the help of voice prompts. They can also understand how long it will be before the light changes color, according to the rhythm or tempo of the sound. Affirmative feedback is also used for guiding the user through the ideal motion in steering tasks in GUI environments. As examples, there are computer-aided design, surgical training, computer gaming and other simulated environments.

However, continuous affirmative multimodal feedbacks may have considerable drawbacks for people with normal sensory capabilities. Firstly, most people do not like to be disturbed when they are performing normally. Imagine how disturbing or annoying it would be if you are driving on a flat road and nonstop vibrations or constant

2.1 Introduction

extraneous sounds, above the normal traffic noise is used to, inform you that you are in the right lane. Secondly, when presented over a long period, continuous tactile or auditory feedback may result in fatigue or even low responsiveness from the user. As a result, the user may not be able to promptly detect feedback that indicates that an abnormal situation requires attention. Thirdly, for motor tasks, the presence of tactile feedback may interfere with the normal motion of the hand and pen and compromise performance. For example, continuous vibrations may affect the stability of a stylus causing lower trajectory accuracy.

Due to several drawbacks with affirmative feedback, we study the effects of feedback only when the cursor is moved out of a tunnel or a specified (required) area in a steering task. In this part, we define this kind of feedback as “error” feedback. In GUI environments, “error” means the cursor is moved outside of the tunnel or the area which the system expects. “Error” feedback can alert the user promptly when she/he makes an “error” in order to make a correction promptly, i.e., it may decrease the error rate. There are several literature review about providing haptic feedback to improve driving performance [23, 24, 32]. However, We observed that, in contrast to the affirmative feedback studies mentioned above, there has been relatively little research on the effects of various types of error feedback in fundamental steering task.

There are many examples of steering tasks in GUI environments, not only hierarchical menu selection, but also computer-aided design, writing, drawing, surgical training, computer gaming and other simulated environments and so on. Here we give some scenarios to show the merits of error feedback.

Menu selection is a traditional steering task in GUI environments. In this scenario, users want to select an item. When the menu button in menu bars is pressed, the pull-down menu appears and users can navigate through this menu and sub-menus. If the cursor is out of the area of pull-down menu and sub-menus, error feedback is triggered

2.1 Introduction

to alert users and prompt them to make corrections. Error feedback can not stop until the cursor returns to the inside of tunnel or the user clicks the left button to end the task.

In a cardiac intervention therapy scenario, a guide wire is pushed through a blood vessel from the leg to the heart. Haptic guidance is often used to simulate the different forces of vessels. Based on the results of this study, vibrations should also be added to prompt the user. The distance between the top of the guide wire and the vessel's walls can be detected. If the top of the wire is too close to the vessel walls, error feedback will be triggered.

In calligraphy practice, children are taught how to write beautiful characters. Tracing paper with standard sharp letters is used; this is a kind of visual feedback. Traditionally, after tracing the characters, children will be given comments by teachers, indicating where they should be more careful when writing particular characters. This post hoc feedback can prove inefficient sometimes. In order to get a better effect, we can apply real-time tactile feedback on the pen, when the pen tip is outside of the printed trajectory (area). In addition, we may create a “pre-warning” buffer area which prompts users before a mistake is made. Given this potential, it is important to have a detailed understanding of different error feedback modalities to inform future software designers.

In driving simulation scenarios, if a car moves too close to the edge of the road, error feedback is used to prompt drivers. This kind of feedback is already used to good effect to warn drivers who unintentionally drift between lanes.

In this part, we review related work and then an experiment is reported which investigates the effects of multimodal feedback on human performance in steering tasks. Several parameters are measured to evaluate accuracy and speed. We conclude with a discussion of our results, implications for feedback design and directions for future

2.2 Related Work

work.

2.2 Related Work

In this section, the related works of both multimodal feedback and feedback location are introduced here.

2.2.1 Multimodal Feedback

A high demand for visual attention is imposed on computer users. This not only causes fatigue, but it also prohibits the performance of secondary activities. The increasing requirement to present a large amount of information to the user also challenges the capacity and effectiveness of visual modality. It becomes necessary to expand the interaction bandwidth by introducing alternative or additional sensory modalities, and many devices [56] [58] [63] [66] [73] [72] [101] have been developed to enable this. For example, Luk et al. [58] created a handheld display platform to provide tactile feedback for users. EarPod [101] enables eyes-free menu selection with the help of reactive auditory feedback, and its performance is comparable to traditional visual techniques in terms of both speed and accuracy. Poupyrev et al. [73] [72] applied tactile feedback not only to desktop computing but also to mobile devices. Liao et al. [56] developed a pen with multimodal pen-top feedback, which effectively helped users detect errors early and provided support for interface discovery.

Akamatsu et al. [4] used a multi-modal mouse to confirm that the cursor was on a target during pointing tasks. Although the overall response times did not change, final positioning time with tactile feedback improved significantly. In another paper, Akamatsu et al. [5] concluded that tactile feedback could reduce selection times. Tactile and force feedback improved performance when the interface contained small tar-

2.2 Related Work

gets. Jacko et al. [44] [45] conducted a series of experiments to examine the effects of multimodal feedback on the performance of senior adults whose visual health varies a lot. Multimodal feedback was triggered when a file icon was correctly positioned. In drag-and-drop tasks, non-visual and multimodal feedback demonstrated significant performance gains over sole visual feedback for both Age-Related Muscular Degeneration (AMD) and normally sighted senior users.

Five different task activities were analyzed in a meta-analysis. Burke et al. [11] compared the effects of uni-modal and bi-modal feedback on user performance. The effects of workload, and the number of tasks were considered. Error rate, performance score, and reaction time were analyzed. The results showed that bi-modal feedback improved performance and reduced reaction times, however it had little effect on error rates.

To investigate the effect of force feedback in steering tasks, Dennerlein et al. [21] used a mouse that employed a force to pull the cursor to the center of the tunnel. Results showed that force feedback improved movement times by 52%. A combined steering and targeting task of navigating through a tunnel and then clicking on a target also showed that force feedback can reduce times to complete such a task. In order to investigate the interaction between the tactile and visual modalities, Campbell and Zhai [16] used an IBM Trackpoint mounted with an actuator and put virtual bumps in the tunnel. When the cursor entered or left a bump, a tactile pulse was triggered to guide the user through the tunnel. They concluded that user performance was enhanced by tactile feedback and that it is important to ensure that the visual feedback corresponds to the tactile feedback.

In summary, our literature review indicates that little work has been done on the study of the relationship between the modalities of error feedback and user performance in steering tasks. This study offers an important basic understanding in this field of

2.2 Related Work

HCI literature.

2.2.2 Feedback Location

Motor skill [80] is widely around us and requires people to control their muscle, joints and body to trajectory with a path accurately, such as riding a bicycle, handwriting, driving a car and so on. Traditionally people learn motor-skills with observation through visual channel and then practice. The teacher's action is recorded by learner's brain and learner follows the same way to practice. Based on the complexity of task and learning capability of learner, the learning time and performance are different.

With the development of haptic technology, more and more haptic devices are applied in daily life. Some studies [82], [57], [7], focus on using haptic technology to improve users' motor-skill learning. Some paid more attention to use pen-based interfaces to simulate the motor skill tasks in the real world, for example, handwriting [83], [98], remote control, virtual realities, and surgical simulation [31] and so on.

Srimathveeravalli and Thenkurassi [83] designed an experiment of character writing to compare the different learning modes supplied to the subjects. There were three modes here: BASIC mode without training assistance, PCONTROL mode with position feedback and ALPHA with force guidance feedback. Results showed that the shape accuracy with haptic attributes guidance was better than the one with position information. Yang et al. [98] gave a study to validate the different performance in short-term and long-term improvement. Subjects were trained for four days. The results proved that subjects gained long-term skill improvement with visuohaptic training. Gibson et al. [31] designed a system to help doctor to explore with real-time force feedback.

Most of these studies mentioned above use Phantom products as equipment to supply user haptic guidance. However, several issues should be considered carefully. First, Phantom products are expensive. They can be used in the laboratory to do

2.2 Related Work

the research. Imagine if the children want to be trained for handwriting learning, is it worth for the parents to buy a Phantom produce? It can not be afforded by normal user. Second, there is an arm in Phantom, which is designed to supply user force feedback and detect the force and direction. However, it affects users' normal actions, because the arm limits the length hand move, and the weight of arm can not be ignored.

In order to avoid these two drawbacks, there were some studies use vibration motors to present user feedback. Hoggan et al. [41] used C2 tactor to give user affirmation when they did the text entry task with touchscreen mobile. Results showed that this feedback improved performance much better than only visual interface. Lee et al. [53] designed a system to present user tactile feedback with pressure-sensitive stylus. The stylus was mounted with a small solenoid to supply different tactile sensations. Forlines and Balakrishnan [30] used the same device as Lee to present user affirmative feedback in pointing and selection tasks. Sun et al. [85] presented an experiment to get the basic understanding of error feedback. Multimodal feedback were used in the experiment. They got the conclusion that tactile feedback improved users' performance in steering tasks. Campbell et al. [16] designed an experiment to prove that tactile feedback can improve steering performance if the visual feedback matched the tactile feedback. In this experiment, tactile feedback was given for the guidance in the tunnel. The drawback of the method in the tunnel is user should follow the tunnel strictly. However, in most of the motor skill tasks or interaction scenario, there is an area or buffer should be allowed user to navigate freely.

There are two kinds of vibration, continuous vibration and single vibration, can be used in the applications. Continuous vibration can remind user continuously but it affects the stability of user's action and makes user feel dysphoric. Single vibration gives a sudden feedback to user. However, this feedback is much weaker than the continuous one. In this experiment, we investigate not only the effect of feedback position but also

2.3 Pilot Study

the effect of two different kinds of feedback.

2.3 Pilot Study

We conducted a pilot study with eight participants to determine suitable feedback parameters for the experiment. A pen with an attached motor was used in the experiment. We wanted to determine the input voltage that would provide maximum comfort and effectiveness for users. Different input voltages (2.0V to 3.6V) supplied to the motor, which mapped to different amplitudes of vibration, were chosen as input parameters. During the pilot study no participants complained that the vibration was significantly disturbing. After summarizing the experiment results and subjective evaluations, most of the participants preferred tactile feedback supplied at 3V. The vibration motor can reach full speed within 60 milliseconds. Compared with the movement time of task, this time delay of motor is not significant and can be ignored. Audio feedback is also discussed. Firstly, we chose the Windows XP Error sound found in the Windows XP Operating System. However, some participants complained that the sound was too loud. We changed it to the sound of Windows XP Notify. Visual feedback was in the form of color change. The results gave us the required data to choose appropriate parameter values for our experiment.

2.4 Experiment 1: Multimodal Error Feedback

2.4.1 Participants

Twelve right-handed university students (10 males, 2 females, aged from 21 to 32 years) participated in the experiment. All participants had normal or corrected to normal vision and reported that they each had normal hearing. Eleven of the participants had previous experience using a stylus. All of them had medium-to expert level

2.4 Experiment 1: Multimodal Error Feedback

computer experience.

2.4.2 Apparatus

The experiment was conducted on an IBM ThinkPad X41 Tablet PC, running Windows XP and using a stylus as the input device. The screen size was 12.1-inches with a resolution of 1024×768 pixels. The experimental software was developed with Java. In order to supply tactile feedback, a vibration motor (2.0V to 3.6V, SE-4F-A3A1-X0, manufactured by Shicoh Engineering Co., Ltd. Japan) was mounted on the stylus. The size of the motor was 4×10.9 mm. The rated speed was 8400rpm. We used adhesive tape to attach the motor to the tail of the stylus, 2 cm from the end. The stylus was about 13 cm long in total. This product was a brushless and geared motor supplied with 3.0Vdc as determined in the pilot study. The electrical signal was supplied by an AD/DA converter card (CSI-360116, manufactured by Interface Co., Ltd. in Japan) and was controlled by the Tablet PC. The motorized pen [53] is shown in Fig.2.1.



Fig. 2.1 Stylus with an attached motor and the motor.

2.4.3 Task and Procedure

There are two kinds of traditional steering task. In general, straight steering represents linear movement and circular steering represents non-linear movement. Our

2.4 Experiment 1: Multimodal Error Feedback

experiment uses a steering task through a circular tunnel (see Fig.2.2). The circular steering task is more complex than the linear movement task. For a circular tunnel, the movement amplitude A is equal to the circle's circumference $2\pi R$, where R is the radius. According to the steering law [1] developed by Accot and Zhai, the index of difficulty for steering through a circular tunnel is $ID = 2\pi R/W$. The task completion time MT can then be expressed in the formula: $MT = a + b ID$, where a and b are empirically determined constants.

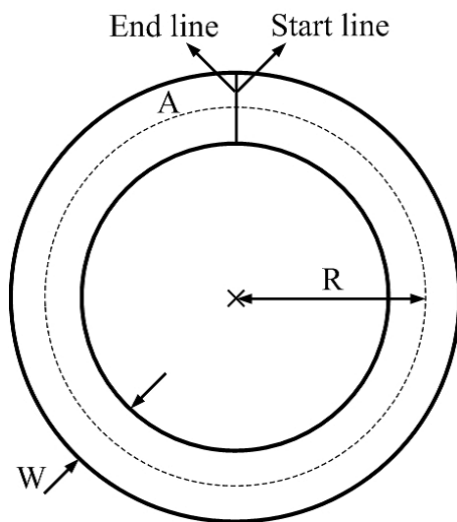

Fig. 2.2 Experimental task.

If the stylus moved out of the boundaries of the tunnel during the task, feedback is presented to the user to indicate an error. We used three modalities for error feedback: visual, auditory, and tactile. Visual feedback turned the steered trajectory (trail) to red when an error occurred. Auditory feedback was a notifying sound that played repeatedly. Tactile feedback was supplied by the vibration of the motor. In all three cases, the error feedback continued until the stylus returned to the tunnel. We also included a baseline condition where there is no feedback.

The direction of the circular steering task was always clockwise. At the beginning of each trial, the tunnel was displayed in the center of the screen. Once the stylus

2.4 Experiment 1: Multimodal Error Feedback

crossed the start line, the color of the drawn trajectory turned from green to blue as a signal that the task had begun. The user then steered the stylus through the circular tunnel. The trial ended once the cursor crossed the end line. Then the next trial was presented.

Before the experiment, the task was explained to the participants and they were asked to perform some warm-up trials in each operational bias until they were familiar with both the steering task and the different kinds of feedback and felt that they could begin the experiments. Participants could adjust the volume of the auditory feedback themselves. The participants were seated and instructed to perform the tasks as fast and as accurately as possible. Participants were allowed to have a rest between trials.

We measured the movement time MT (time taken to move from the start line to the end line). To measure the accuracy of the trajectory produced, we calculated its lateral standard deviation SD (standard deviation of the distances between trajectory points and the center of the circular tunnel) and out of path movement OPM (percentage of trajectory points outside the tunnel boundary). For both SD and OPM , higher values indicate lower accuracies. In this part, we use the OPM to measure the out of path movement. This metric was previously used by Kulikov et al. [51]. During the period of one trial in this experiment, we recorded the coordinates of sample points per 10 milliseconds. The number of sample points and the number of times the pen-tip moved out of the tunnel between these sample points were collected. The value of OPM was calculated by these two parameters. For example, if 100 points were sampled and 14 of those points were outside the Constraint lines, then OPM would be 14.

2.4.4 Design

We used a fully crossed within-subject factorial design. The independent variables were: *tunnel width* W (12, 20, 30, 40, 50, 60 pixels), *tunnel amplitude* (300, 600, and

2.4 Experiment 1: Multimodal Error Feedback

800 pixels), and *feedback type* (no feedback (NONE), auditory (A), tactile (T), visual (V), auditory + visual (AV), visual + tactile (VT), auditory + tactile (AT), auditory + visual + tactile (AVT)). Each participant performed the experiment using all 8 feedback types in sequence. The presentation orders of the feedback types were counterbalanced across participants.

All participants conducted the experiment in sitting postures. Within each *feedback type*, the participant performed all combinations of *tunnel widths* and *tunnel amplitudes* 3 times each and presented in random order.

In summary, the experiment consisted of:

12 participants ×
8 feedback types ×
6 tunnel widths ×
3 trials ×
3 tunnel amplitudes
= 5184 times in total.

The experiment took approximately 30 minutes per participant. After the experiment, participants completed a questionnaire to rate their subjective preferences for the feedback types.

2.4.5 Hypotheses

- H1. Feedback type will affect movement time, especially when the task is difficult.
- H2. Feedback type will affect accuracy.
- H3. The single tactile feedback outperforms other individual feedback modalities.

2.4 Experiment 1: Multimodal Error Feedback

2.4.6 Results

Repeated measures of analyses of variance were used to assess the effects of multimodal error feedback (eight kinds) on movement time, standard deviation and out of path movement.

Movement Time (MT)

An ANOVA test showed that there was no significant effect ($F_{7,77} = 0.575, p = 0.774$) from *feedback type* on the movement time *MT*. The index of difficulty ($ID = 2\pi R/W$) for the tasks had a significant main effect ($F_{14,154} = 91.666, p < 0.001$), with higher *ID* corresponding to longer *MT*. There was no significant interaction effect from *feedback* \times *ID* ($F_{98,1078} = 1.118, p = 0.212$). The overall means for *MT* were 1567, 1657, 1600, 1601, 1588, 1582, 1595, and 1619 ms for the NONE, A, T, V, AV, VT, AT, and AVT feedback (see Fig.2.3). The movement time with NONE feedback was the shortest among these feedback types.

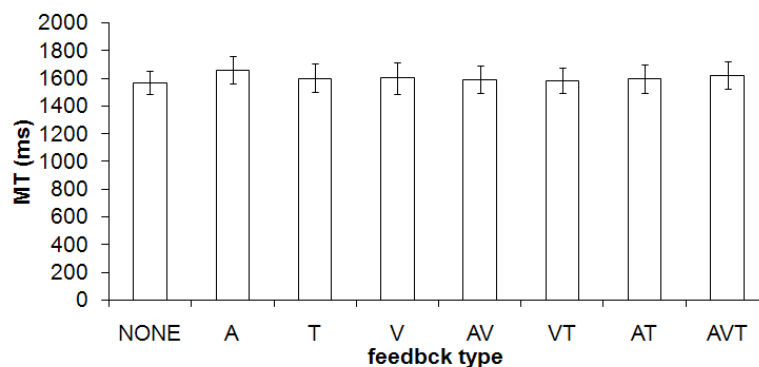

Fig. 2.3 Mean MT by different feedback types (with standard error bars).

The regression analysis on *MT* and *ID* indicated that they followed a linear relationship with each *feedback type*, as predicted by the steering law ($R^2 > 0.97$ in all cases).

2.4 Experiment 1: Multimodal Error Feedback

Standard Deviation (SD)

The overall mean of SD is 4.62 pixels (see Fig.2.4). The main effect of feedback type was statistically significant ($F_{7,77} = 2.148, p = 0.048$) on SD . There was also a significant effect ($F_{14,154} = 110.05, p < 0.001$) of ID on SD . There was no significant interaction effect from $feedback\ type \times ID$ ($F_{98,1078} = 0.876, p = 0.796$). Pair-wise comparison tests showed that the participants produced significantly lower SD ($p < 0.05$) with the A feedback and T feedback compared with the other feedback types and significantly higher SD ($p < 0.05$) with AV and V compared with the other feedback types. There was no significant difference in SD between A and T, or between AV and V. The baseline performance with NONE feedback was between these two extremes, however this difference was not statistically significant.

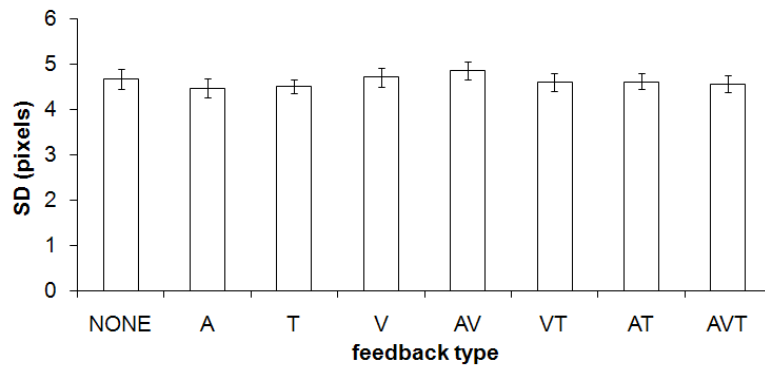

Fig. 2.4 Mean SD with different feedback types.

Out of Path Movement (OPM)

The overall mean of OPM was 2.35% (see Fig.2.5). The main effect of feedback type was statistically significant ($F_{7,77} = 3.458, p = 0.003$) on OPM . There was also a significant effect ($F_{14,154} = 13.942, p < 0.001$) of ID on OPM . There was no significant interaction from $feedback\ type \times ID$ ($F_{98,1078} = 1.034, p = 0.395$). Pair-wise compar-

2.4 Experiment 1: Multimodal Error Feedback

ison tests showed that the participants produced significantly lower *OPM* ($p < 0.05$) with the AVT feedback and T feedback compared with the other feedback types and significantly higher *OPM* ($p < 0.05$) with NONE, V, AV and VT compared with the other feedback types. There was no significant difference in *OPM* between AVT and T, or between NONE, V, AV and VT.

Summarizing the experimental data, we showed that different modalities of feedback significantly affected human performance in steering tasks in terms of accuracy but not in terms of completion time. From the results of *OPM* and *SD*, we concluded that users performed the task most accurately with tactile (T) feedback, and least accurately with AV (auditory + visual) and V (visual) feedback.

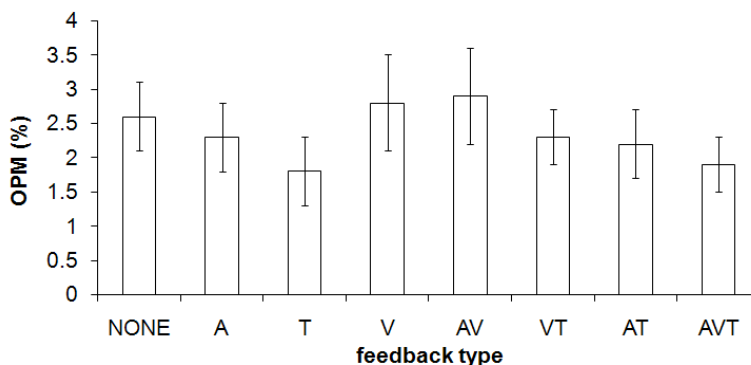

Fig. 2.5 Mean OPM with different feedback types.

Subjective Evaluation

According to the results of the questionnaire, the majority of participants (8/12) preferred AV feedback to indicate an error condition. The reason is that “hearing the sound feels comfortable and gives a clear warning. Compared to sole auditory feedback, the additional visual modality makes cursor movement more accurate”. Some participants (7/12) disliked tactile feedback because “vibration from the motor disturbed the

2.4 Experiment 1: Multimodal Error Feedback

movement of the pen-tip”, but, one participant highly praised the direct and active response delivered by tactile feedback. Some participants (7/12) disliked AT and AVT feedback, because they felt “the combination of auditory feedback and tactile feedback confused them”.

Steering Law Analysis

Each of the feedback modalities fit the steering model with correlations greater than 0.97. As mentioned before, there was no significant effect from feedback type on the movement time MT . The indexes of performance ($IP=1/b$) for different feedback types are similar.

Table 2.1 Steering law models with different feedback

Feedback	Steering law model	R^2
NONE	$MT = 64.7 ID + 87.5$	0.98
A	$MT = 64.7 ID + 177$	0.99
T	$MT = 67.9 ID + 47.7$	0.98
V	$MT = 67.3 ID + 61.8$	0.98
AV	$MT = 68.3 ID + 26.2$	0.97
VT	$MT = 67.8 ID + 32.1$	0.98
AT	$MT = 64 ID + 130.3$	0.99
AVT	$MT = 68.8 ID + 45.6$	0.98

2.5 Experiment 2: Feedback Locations

2.5.1 Participants

Six right-handed university students (4 males and 2 females; aged from 20 to 32 years old, mean age 25.3) were recruited to participate in the experiment. All participants had normal or corrected to normal vision. All of them had medium to expert levels of computer experience, and all of them had prior experience with this devices.

2.5.2 Apparatus

An IBM ThinkPad X41 Tablet PC was used in our experiment, with a default stylus as input. The screen size was 12.1 inches (1024×768 pixels resolution). The experimental software was developed in Java Environment and ran on a 1.5 GHz CPU with Microsoft Windows XP tablet edition. We used a haptic pen to give user tactile feedback. The motor was SE-4F-A3A1-X0, manufactured by Shicoh Engineering Co., Ltd. Japan. It was mounted at the end of the stylus with black tape and given 3.0 Vdc.

2.5.3 Task and Procedure

This task and procedure are the same as those ones in experiment 1 (see Fig.2.6). Visual, tactile, and visual plus tactile feedback were investigated in this experiment. There were three feedback position designed in this study. The feedback which was applied in the tunnel was called IF method. It was a kind of guidance and was similar with dumm drift. We also designed the feedback interface that put the feedback outside of the tunnel which was called OF method or at the boundary of the tunnel which was called BF method.

In IF method, if the cursor was in the tunnel, the trajectory was blue and there was no tactile feedback. If the cursor was out of the tunnel, the trajectory was changed to

2.5 Experiment 2: Feedback Locations



Fig. 2.6 Experiment environment.

red with visual feedback, the motor started to vibrate continually and gave user tactile feedback, until the cursor went back inside of the tunnel and the two feedback were given with visual plus tactile feedback. In OF method, all the situations were opposite. In BF method, when the cursor moved from inside to outside of the tunnel, the color of circle changed to red once and then turned back to default color with visual feedback; a single sudden vibration was given with tactile feedback.

2.5.4 Design

This part employed a within-subject design. The within-subject factors were: *tunnel width* W (20, 30, 40, 50, 60 pixels), *tunnel amplitude* A (300, 600, and 800 pixels), *feedback position* (inside, boundary, outside) and *feedback type* (tactile (T), visual (V), visual + tactile (VT)). Each condition contained 3 trials. Presentation of trails was randomized.

We used a fully crossed within-subject factorial design. The independent variables were: *tunnel width* W (12, 20, 30, 40, 50, 60 pixels), *tunnel amplitude* A (300, 600, and

2.5 Experiment 2: Feedback Locations

800 pixels), and *feedback type* (no feedback (NONE), auditory (A), tactile (T), visual (V), auditory + visual (AV), visual + tactile (VT), auditory + tactile (AT), auditory + visual + tactile (AVT)). Each participant performed the experiment using all 8 feedback types in sequence. The presentation orders of the feedback types were counterbalanced across participants.

All participants conducted the experiment in sitting postures. Within each *feedback type*, the participant performed all combinations of *tunnel widths* and *tunnel amplitudes* 3 times each and presented in random order.

In summary, the experiment consisted of:

6 participants ×
3 feedback types ×
5 target widths ×
3 trials ×
3 feedback positions ×
3 tunnel amplitudes
= 2430 times in total.

2.5.5 Results

Movement Time (MT)

Movement time was recorded from the time when participant crossed the start line to when he or she crossed the end line. A repeated measures analysis of variance showed that there was a significant main effect of feedback position ($F_{2,22} = 2.538, p < 0.05$) on movement time. Mean movement time (see Fig.2.7) with OF method was the shortest and the one with BF method was shorter than the one with IF method. It meant if the cursor was out of the tunnel, user could drag the cursor back fastest when feedback

2.5 Experiment 2: Feedback Locations

position is outside of the tunnel. There was no significant main effect of feedback type on movement time.

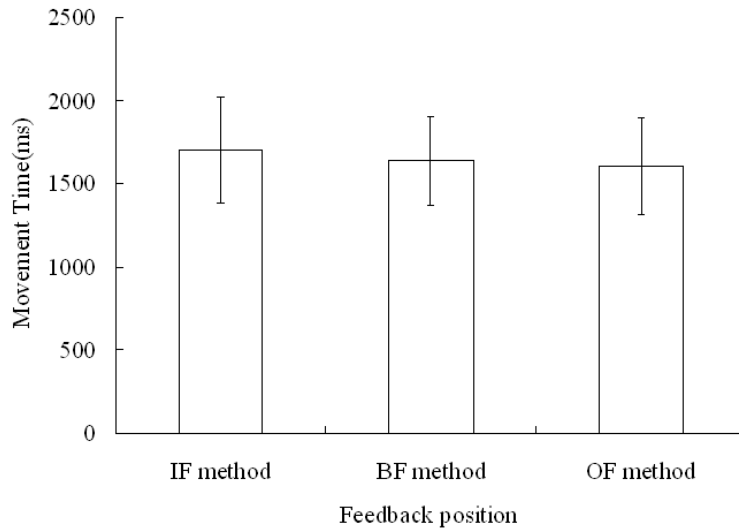

Fig. 2.7 Mean Movement time with different feedback positions.

Standard Deviation (SD)

Standard Deviation is a parameter to investigate the distance between the trajectory and the central line of the tunnel. A repeated-measures ANOVA showed there was no significant main effect for feedback position on standard deviation ($F_{2,22} = 1.95, p = 0.166$). Mean Standard Deviation (see Fig.2.8) with IF method is the smallest and the one with OF method was smaller than the one with BF method. The mean of standard deviation was 4.825 pixels.

Out of Path Movement (OPM)

Standard deviation could investigate the correct rate of experiment. If someone liked dragging along the boundary of the tunnel, it's a correct action, but the value of

2.5 Experiment 2: Feedback Locations

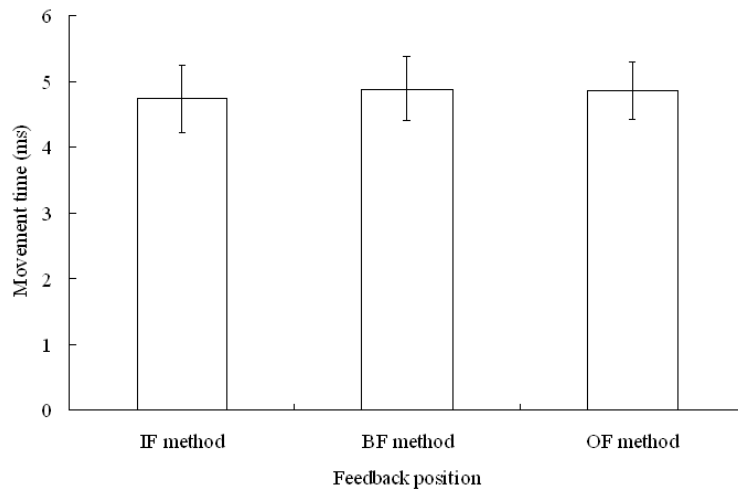

Fig. 2.8 Mean SD with different feedback positions.

SD was higher. In order to avoid this point, in this study, we also recorded OPM which revealed how many times cursor was out of the tunnel. When the value was higher, it meant the more error happened.

A repeated-measures ANOVA showed that there was no significant main effect for feedback position on OPM ($F_{2,22} = 0.073, p = 0.93$). The values of OPM with different position were almost the same (see Fig.2.9).

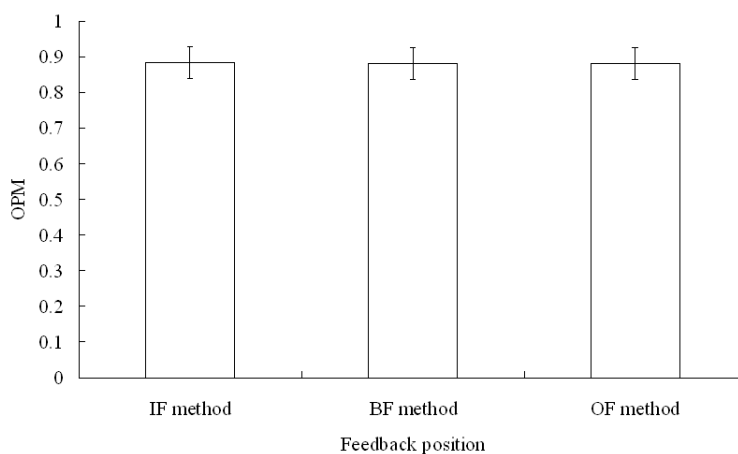

Fig. 2.9 Mean OPM with different feedback positions.

Subjective Evaluation

After the experiment, participants were asked to answer several subjective questions. None of them felt tired when they were given tactile feedback with vibration. Generally most of them preferred tactile feedback should be given outside of the tunnel (see Fig.2.10). No one liked feedback supplied inside of the tunnel.

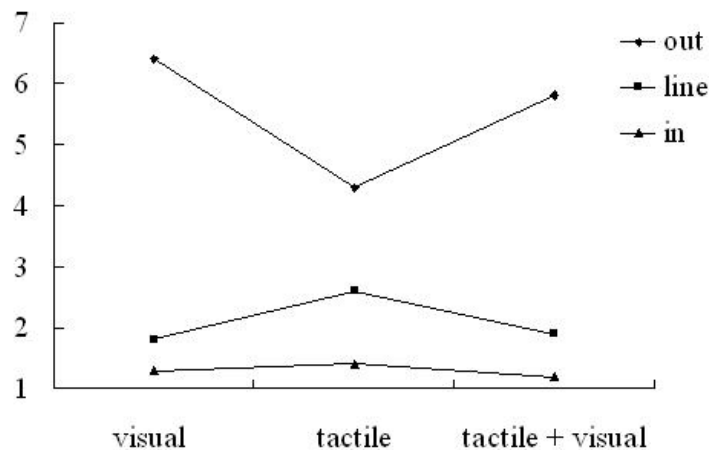

Fig. 2.10 Subjective evaluation with different feedback positions.

2.6 Discussion

2.6.1 Multimodal Error Feedback

This study investigates the relationship between “error feedback” (when tracking or trajectory errors are made) and user performance in steering tasks. The experiment examines feedback presented in visual, auditory and tactile modalities, both individually and in combinations. In the experiment, the analysis of *SD* and *OPM* shows that *feedback type* affects accuracy significantly. The simple tactile error feedback (T), outperforms the other error feedback types and combinations in steering tasks. In contrast to H1, no significant effect of *feedback type* on *MT* was found. However,

2.6 Discussion

Forlines and Balakrishnan [30] found that *feedback type* did have a significant effect on completion time in their study on pointing and crossing tasks. Although Akamatsu et al. [5] concluded the effect is more pronounced for small targets for the tactile condition, we cannot draw the same conclusion from the results of our experiment. These observations could be explained by their different usage of feedback. They used feedback as an affirmation, e.g., notifying the user when the tip of the cursor was on a target. Therefore the feedback was always in effect in every trial. By contrast, in our study we used feedback as an alarm to indicate errors. There are two possibilities in extreme cases. Firstly, if the tunnel is wide enough, no error occurs during the trial and no feedback was presented. Secondly, if the tunnel is too narrow, error activated feedback is very similar to “affirming” feedback. In summary, feedback type was irrelevant to the overall temporal performance in most cases.

On the other hand, feedback directly contributed to the reduction of errors in the task and therefore, feedback type has a significant effect on performance accuracy, and thus H2 is confirmed. Comprehensive analysis of *OPM* and *SD* confirms that the simple tactile feedback (T) outperforms or is similar to all other feedback types (both single and combined), thus confirming hypothesis H3. This phenomenon may also be explained from the following point. We used a direct input device in this study. Visual feedback is more or less unavailable when the target is covered by the hand or stylus (this particularly relates to the sitting posture and writing posture). Compared with audio feedback, tactile feedback is a real-time interactive modality. It transforms information through skin displacement both in space and time, while audio feedback is transmitted through the air and has some delay.

An interesting observation is the apparent disparity between the actual performance of the users and the subjective preferences of the users. Despite the fact that the majority of participants felt that tactile feedback disturbed the movement of the

2.6 Discussion

pen-tip, they all achieved the highest level of accuracy with tactile feedback. This could indicate that participants wanted to avoid triggering the vibration so that they performed the task more carefully, i.e., this probably explains why tactile feedback was so effective. Visual feedback does not impact the user forcefully and is the easiest to ignore. This may be the reason the lowest levels of accuracy are produced by the AV and V feedbacks. This tradeoff between performance and comfort may guide us to choose the most suitable form of feedback in different scenarios. In addition, the different human response times for different sensory channels (with tactile being the fastest [79], while visual and auditory having more considerable delay) may have also contributed to the performance difference.

Considering these points, we suggest that error feedback mechanisms, as investigated in this part, might be the most suitable applications for tactile feedback, where the feedback is presented intermittently to indicate abnormal situations rather than continuously to indicate normal situations. The results of our experiment confirmed the suitability of the tactile modality for this purpose, especially in the context of a steering task. Accot and Zhai [1,2] gave some examples of steering tasks. For example, drawing, writing, and steering in 3D space. Error feedback can be widely used to improve the performance of these tasks, or used as a training tool such as to teach handwriting.

Based on the result of our experiments, the simple tactile error feedback (T) outperformed the other feedbacks. The GUI is designed for visual feedback but audio feedback and tactile feedback are not considered. Campbell et al. [16] also mentioned that today's GUIs may be not suitable for tactile feedback. A new user interface should be proposed to replace the ones we use now.

2.6.2 Feedback Location

In this study, we use the vibration to give user tactile feedback. The experiment results showed that feedback position affected movement time significantly and outside feedback method took the shortest time to finish the trajectory task. The possible reason was that user moved the stylus freely and performed an initial action inside the tunnel without any disturbance in outside method. Once the error happened, they were reminded with the help of three feedback types. Compared with inside method, the user did not need to receive the feedback for a long time. The feedback for a long time may cause the fatigue and decrease the sensitivity of response. Although the tactile feedback on the inside of the tunnel was a kind of guidance, it decreased the speed of stylus movement. Compared with boundary method, the most difference between outside method and boundary method was single feedback or continual feedback. The possible reason was that when participant focused on finishing the trajectory task, they were so rapt that they might miss the single feedback and continual feedback could improve this point.

Although the experiment results showed that there was no significant difference among three feedback positions in accuracy, subjective evaluation indicated that most of the participants preferred outside method. Someone said that “I don’t want to be disturbed when I’m correct”. In summary, we get the conclusion that 1) feedback should be given on the outside of the tunnel, and 2) vibration technology is a good method to improve the abilities of acting in the 3D dimensional. These conclusions can be used to improve the several existed motor learning applications, for instance, handwriting, sports training, playing musical instrument, skiing and so on.

When children learn how to play violin, the most basic and important technique is how to control the bow which has a high relationship with tone. Generally, teacher

2.6 Discussion

introduces how to play it face to face. The teacher plays firstly and children should follow the same way to do that. The teacher corrects the wrong posture and guides children to practice. However, the time when children practice alone is much longer than the one when they practice with the help of teacher. In order to correct the wrong posture without the guidance of teacher, we can mount several motors at the different parts of the body and OF method is used. When they perform correct, there is no vibration feedback. When they do not control the bow to the right position, the motor will vibrate and remind user to correct the action. Through this method, children can learn to play violin by themselves.

2.6 Discussion

This is a blank page.

Chapter 3

A Comparison of Multimodal Feedback in Pointing Task with Tracking State

3.1 Introduction

The digital stylus, which is similar to a common pen, has long been used as an input device. It is used in PDAs, Tablet PCs, Graphics Tablets and Ultra Mobile PC (UMPC). There are two modes in pen-based interaction: ink mode and gesture mode. Ink mode allows users to input handwriting, drawing etc. Gesture mode allows users to manipulate the entered data. Many researchers [29, 37, 55] have paid attention to how to switch between the two modes efficiently and naturally. Most of them applied an additional button and pen gesture to improve mode switch. However, these methods are unnatural for user to control and hard for the computer to interpret. Furthermore, the user's focus on the current task is often disturbed by these methods.

Recently, the tracking state (hover state) is used to deal with this problem [13]. There are three states in a pen operation (see Fig.3.1): non-sensed state, tracking state and dragging state. Most pen-based devices, such as Tablet PCs, the Wacom pad and display, have the tracking state. However, it is different from tapping with a stylus due to the lack of effective feedback. Users can get feedback through haptic modality when

3.1 Introduction

the tip of the stylus touches surface. Visual feedback is invisible for user until the tip of the stylus enters the “above-the-surface” interaction layers. Due to the hand and stylus cover significant parts of the display, it is hard for user to know whether the stylus is in the tracking state [30]. This delays the user’s awareness of the tracking state status. This phenomenon will lead two possibilities in extreme cases. Firstly, if the user is too careful with slow movements, it will increase trigger time. Secondly, if the user is too urgent with rapid movements, accidental missed tracking state may be produced, e.g., directly touching the screen surface, resulting in an unexpected outcome. Audio and tactile technologies have developed to a stage where we can apply these modalities to alert the user while in the tracking state. One question should be asked: “which feedback can help users to get the best performance in tracking state?” However, there is no study on this question. In this study, we want to offer an important basic understanding of this issue.

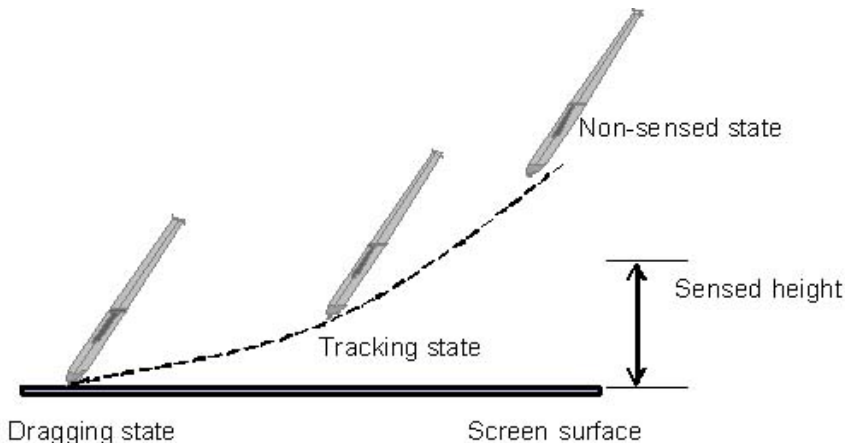

Fig. 3.1 Pen Operation States.

In the following sections, we begin with a review of related work and then we report on two experiments which investigate the effects of multimodal feedback on human performance for two different pointing tasks in the tracking state. Several parameters are measured to evaluate accuracy and speed. Both direct and indirect pen-based

3.2 Related Work

devices are investigated. We conclude with a discussion of the results, implications for feedback design in the tracking state and directions for the future work.

3.2 Related Work

3.2.1 Tracking State

Tracking state and space above the work-surface [33,34,47] have been investigated recently. For example, Subramanian et al. [84] presented an experiment to investigate multiple layers of interaction above the tablet. The results revealed that all subjects could control the stylus and move between layers naturally and easily. Grossman et al. [33] used a backwards 'L' shape to activate a hover widget which was a new command layer. This extended the capabilities of pen-operated devices. Instead of moving the cursor to click on an icon, users could trigger the mode switch command in the current work area. The experiment showed that a mode switch with a hover widget was faster than the traditional command activation technique and it also reduced the error rate.

Kattinakere et al. [47] explored human capabilities for performing steering tasks. A new model was proposed and results showed that the model was effective in predicting movement times when steering through constrained tunnels. The pointing task was also an important task in pen-based interaction. However, little work has been done to explore the human capabilities for pointing tasks in the tracking state. In this study, we investigate pointing tasks which are the fundamental tasks in human computer interaction.

3.2.2 Effects of Multimodal feedback

When audio and tactile perception feedbacks are included in the GUI, one particular question should be answered: with what combination of multimodal feedback can

3.3 Pilot Study

users get the best performance in a GUI interface? Numerous studies have been done in this field. Akamatsu et al. [4] showed that the addition of tactile or audio information did not dramatically improve overall response times or error rates in a routine target selection task. But, in the final positioning times, tactile feedback was the quickest among the feedback modes tested. Burke et al. [11] compared visual-auditory and visual-tactile feedback to visual feedback alone with a meta-analysis. The results showed that reaction time and performance were improved when an extra modality was added to visual feedback, but the error rate was not reduced. Jacko et al. [1,45] conducted a series of experiments to examine the effects of multimodal feedback on the performance of older adults with different visual abilities. In drag-and-drop tasks, their overall results indicated that non-visual and multimodal feedback forms demonstrated significant performance gains over the visual feedback form, for both AMD (Age-Related Macular Degeneration) and normal sighted users. Emery et al. [22] designed the experiment so that older adults were grouped based on different levels of computer experience in a drag-and-drop computer task. The results showed that, under auditory-haptic bimodal feedback, all subjects performed well and experienced users all preferred multimodal feedback. Vitense et al. [91,92] showed that the bimodal condition of haptic and visual feedback was beneficial to user performance.

In summary, our literature review indicates that little study has been done on the study of multimodal feedback for pointing tasks in the tracking state. This study offers an important basic understanding in this significant field of pen-based interaction.

3.3 Pilot Study

A pilot study was conducted to determine appropriate parameters for multimodal feedback for the experiment. Eight right-handed subjects participated in the pilot study

3.3 Pilot Study

(6 males and 2 females) and their average age was 21.2 years. All participants had normal or corrected to normal vision and reported that they each had normal hearing.

Two kinds of motors (see Fig.3.2) were applied as tactile feedback in our experiment. One was a vibration motor (2.0 volts to 3.6 volts, SE-4F-A3A1-X0, manufactured by Shicoh Engineering Co., Ltd. Japan) mounted on the stylus. The size of the motor was 4×10.9 mm. The rated speed was 8400rpm. We used adhesive tape to attach the motor to the tail of the stylus, 2 cm from the end. Another one is a flat coreless vibration motor (2.5 volts to 3.5 volts) attached to the non-dominant hand with a belt. The size of the motor was 3.4×12 mm. The rated speed was 13000rpm.

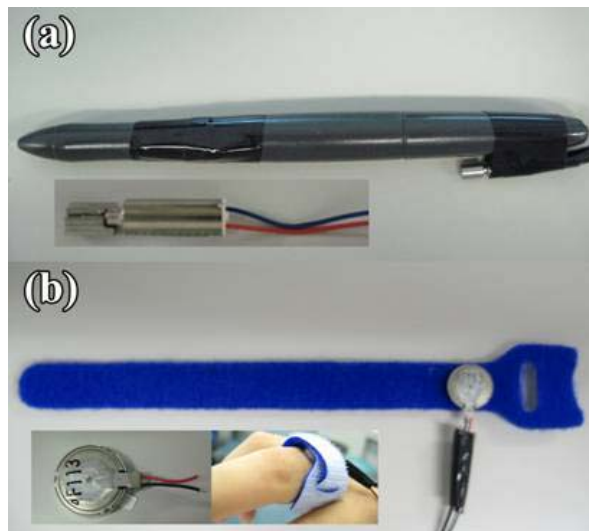

Fig. 3.2 (a) Motorized Pen; (b) Motorized Belt.

Vibrations were given using the first motor with different volts (2.0, 2.5, 3.0, and 3.6 volts) and the second motor with different volts (2.5, 2.75, 3, 3.25, and 3.5 volts). Subjects were asked to answer the questions about ease of use and fatigue with a Likert scale. The question about ease of use was “how comfortable and undisturbed can you feel when vibration is supplied?” and the question about fatigue was “How tiring is it to feel the vibration?” The Likert scale range from 7 (“comfortable” or “undisturbed”) to 1 (“very tired” or “badly disturbed”).

3.4 Experiment 1: 1D Pointing Task

None of the subjects felt tired when different input voltages were supplied to the motor. After summarizing the results and subjective evaluation, we determined the tactile feedback input voltage. 2.5v was supplied to the first motor while 3.0v was supplied to the second one. The “notify” sound from the Windows XP Operating System was used for audio feedback. Visual feedback was in the form of colour change.

3.4 Experiment 1: 1D Pointing Task

3.4.1 Participants

Twelve right-handed university students (10 males, 2 females, average age 22.7 years old, aged from 20 to 32 years) participated in the experiment. All participants had normal or corrected to normal vision and reported that they each had normal hearing. All of them had medium to expert levels of computer experience.

3.4.2 Apparatus

The experiment was conducted on a Dell Latitude D620, running Windows XP. The experimental software was developed with Java and Visual C++ 6.0 using Java Native Interface. Motors were introduced in the pilot study. We chose a display tablet (Wacom DTI-520) [93] with a stylus (12.5×146.5 mm, 10g) as the direct input device (left in Fig.3.3). A Wacom tablet (Wacom Intuos3 PTZ-430) [94] with a stylus (18.8 ×174.8 mm, 17g) was used as the indirect input device (right in Fig.3.3). The computer can detect the coordinates (x, y) of pen-tip even when it is above the tablet screen surfaces (within a height of 18 mm).

3.4 Experiment 1: 1D Pointing Task



Fig. 3.3 Indirect input (left); direct input (right).

3.4.3 Task and Procedure

Fitts' law [1, 27, 60] is a model which predicts movement time and reveals the relationship that models speed and accuracy tradeoffs in target selection tasks. The selection time T , when pointing to a target of width W , and at a distance A , is linearly related to the index of difficulty ($ID = \log_2 (A/W + 1)$) for pointing. The formula is: $T = a + b \times ID$, where a and b are empirically determined constants.

In our experiment, two targets were presented on the screen (see Fig.3.4) at the beginning. When the stylus pen was in the starting target area and in the tracking state, the user pressed the “Enter” key with the non-dominant hand (Li et al. [55] concluded that the most effective technique for switching was using the non-preferred hand button) and the experiment began. When the stylus was in the other target area with tracking state, multimodal feedback reminded the user, the user pressed the “Enter” key and the time was being recorded. Visual, audio and tactile modalities, both individual and combined, were used for feedback. Visual feedback turned the target to green. The Auditory feedback played the “notify” sound to warn the user. Tactile feedback was supplied by the vibration of the motor. These multimodal feedbacks were triggered when the stylus was in the tracking state. Feedback would not stop until the user confirmed by pressing the “Enter” key which was the signal of the end of the trial.

The experimental process was introduced to the users before the experiment. All

3.4 Experiment 1: 1D Pointing Task

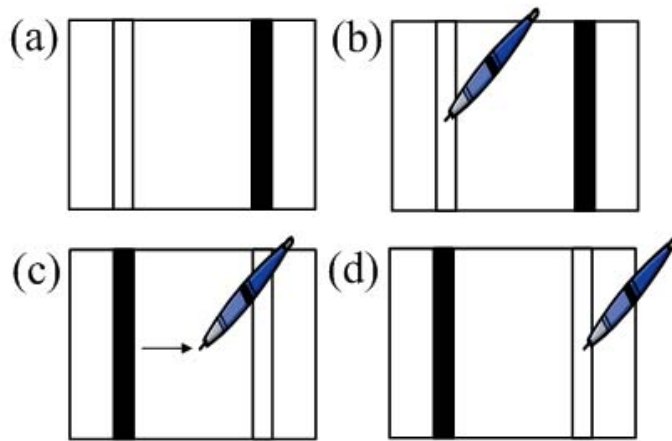

Fig. 3.4 The Process of 1D pointing task in tracking state.

of the subjects were seated with an earphone and asked to practice until they were familiar with the experiment and with multimodal feedback. They could adjust the volume of the audio feedback by themselves. In order to avoid fatigue, they could have a rest in the intervals between trials. They were asked to perform the tasks as fast and accurately as possible. Loss of tracking state resulted in the failure of the trial and subjects were asked to do the trial again. The movement time (MT) recorded the whole time from subject pointed the starting target to they pointed the ending target in tracking state. The error rate showed the percentage of points outside the purpose target. After the experiment, the subjects were asked to answer a questionnaire and give their preferences. The levels of fatigue and usability were measured. The Likert scale range from 1 (“comfortable” or “undisturbed”) to 7 (“very tired” or “badly disturbed”). The subjects were asked to give the preference finally.

3.4.4 Design

Independent variables were target Width ($W = 4, 8, 16$ and 32 pixels), distance between two targets ($A = 250, 500, 750$ pixels), input devices (direct and indirect), different motors attached on either the stylus or to the non-dominant hand with a belt,

3.4 Experiment 1: 1D Pointing Task

and feedback type or combination (i.e. no feedback (NONE), auditory (A), tactile (T), visual (V), auditory + visual (AV), visual + tactile (VT), auditory + tactile (AT), tactile+ visual + auditory (TVA)). The index of difficulty had 9 different values. For each trial, subject performed the task with all combinations of different conditions. The experiments were counterbalanced between participants. All of the independent variables, such as multimodal feedback type, tactile feedback (which hand), input devices, tunnel widths and tunnel amplitudes, were presented in random order. In this study, the screen resolution is 1024×768 pixels and 1 pixel is equal to 0.297mm. Subjects spent half an hour to finish this experiment.

In summary, the experiment consisted of:

12 participants \times
8 feedback types \times
4 target widths \times
3 trials \times
3 distance between targets \times
2 types of input devices \times
2 different hands \times
= 13824 times in total.

3.4.5 Hypotheses

- H1. Feedback types will affect movement time in 1D pointing tasks (tracking state).
- H2. Feedback types will affect error rate in 1D pointing tasks (tracking state).
- H3. Types of input devices will affect movement time in 1D pointing tasks (tracking state).
- H4. Types of input devices will affect error rate in 1D pointing tasks (tracking state).

3.4 Experiment 1: 1D Pointing Task

H5. Different hands will not affect movement time in 1D pointing tasks (tracking state).

H6. Different hands will affect error rate in 1D pointing tasks (tracking state).

3.4.6 Results

Several variables were measured by repeated measures of analyses of variance. The hypotheses were evaluated in this part.

Movement Time (MT)

A repeated-measure ANOVA showed a significant effect for Input device type ($F_{1,11} = 18.415, p = 0.001$) on movement time. Averaging all the experiments, the direct input method (see Fig.3.5) was 12.6 % faster than the indirect input method (see Fig.3.6), thus confirming hypothesis H3. In contrast to H1, there was no significant effect for feedback type ($F_{7,77} = 1.973, p = 0.070$). There was no significant effect for different hands ($F_{1,11} = 1.240, p = 0.289$) on movement time, thus confirming H5. The regression analyses on MT and ID indicated that they followed a linear relationship in each experiment, as predicted by Fitts' law (all $R^2 > 0.90$).

Error Rate

A repeated-measure ANOVA showed a significant effect on error rate for input device type ($F_{1,11} = 23.833, p = 0$). Averaging all experiments, the error rate for indirect input (see Fig.3.8) was 68.9% more than the error rate for direct input (see Fig.3.7), thus confirming hypothesis H4. There was a significant effect for feedback type ($F_{7,77} = 2.865, p = 0.010$), thus confirming hypothesis H2. T and NONE produced the lowest error rate while audio feedback (either by itself or in combination with tactile

3.4 Experiment 1: 1D Pointing Task

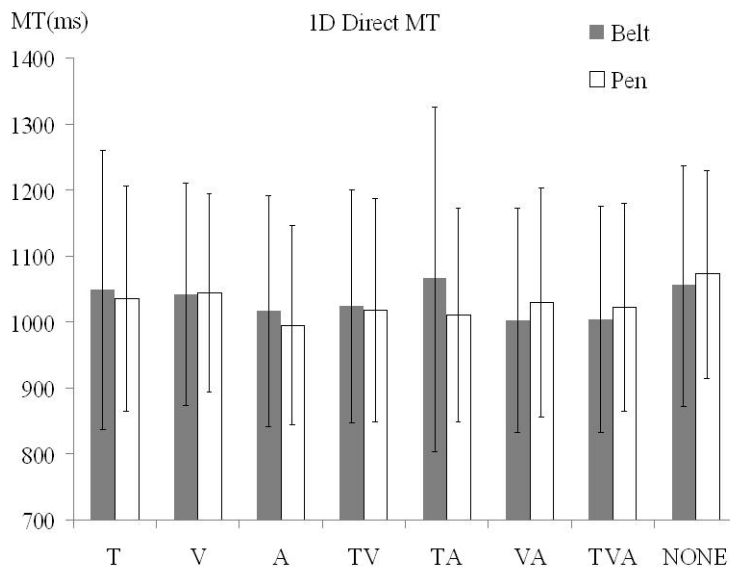

Fig. 3.5 Mean MT by different feedback types with direct input device in 1D pointing tasks (Error bars represent 95% confidence interval).

and visual) produced the highest error rate. In contrast to H6, there was no significant effect for different hands ($F_{1,11} = 0.298, p = 0.596$).

Subjective Evaluation

After the experiment, subjects were asked to answer a questionnaire and give their preferences. The level of fatigue and usability were measured. The results showed that there was no significant effect for all parameters on fatigue. NONE and A feedback types rated a low level of usability. Fig.3.9 shows the results of 7-point Likert Scales with different tools and different feedback types. Most subjects preferred the TV feedback (see Fig.3.9). They said “visual feedback can help in the normal condition. If the target was covered by hand, tactile feedback reminded me clearly”.

3.5 Experiment 2: 2D Pointing Task

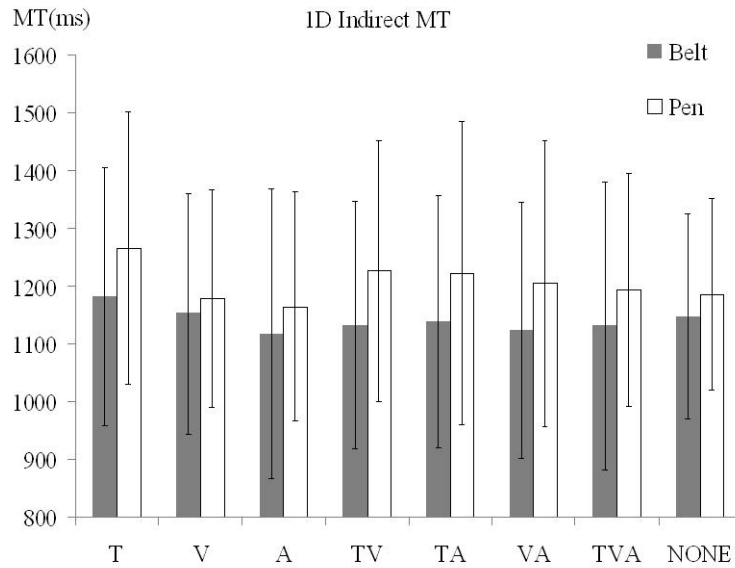

Fig. 3.6 Mean MT by different feedback types with indirect input device in 1D pointing tasks (Error bars represent 95% confidence interval).

3.5 Experiment 2: 2D Pointing Task

3.5.1 Participants

Twelve right-handed university students (10 males, 2 females, average age 22.3 years old, aged from 20 to 32 years) participated in the experiment. All participants had normal or corrected to normal vision and reported that they each had normal hearing. All of them had medium-to expert level computer experience.

3.5.2 Apparatus

The apparatus is the same as that used in experiment 1.

3.5.3 Task and Procedure

Two-dimensional target acquisition tasks [61,62] are commonly applied in Human Computer Interaction. Fitts' law also models 2D pointing tasks. Beyond 1D pointing

3.5 Experiment 2: 2D Pointing Task

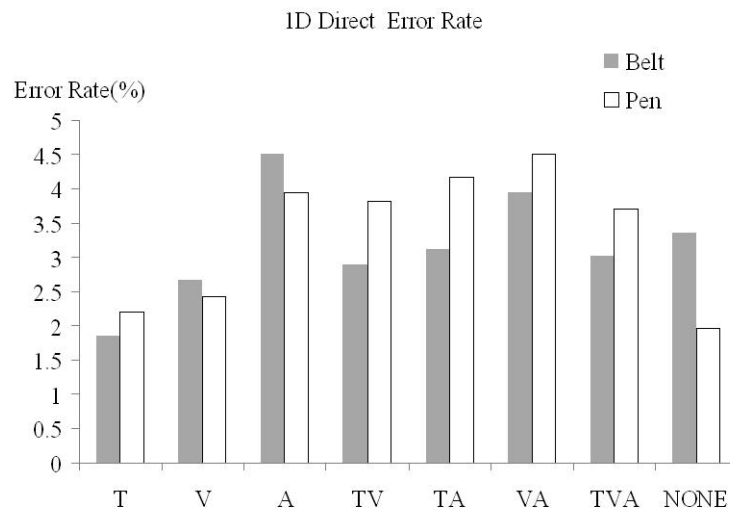

Fig. 3.7 Error rate by different feedback types with direct input device in 1D pointing tasks.

tasks, different directions (see Fig.3.10) are discussed in 2D pointing tasks and it is necessary to investigate 2D pointing tasks.

In this experiment, one circular target was presented on the screen (see Fig.3.11) at the beginning. When the stylus pen was both in the starting target area and in the tracking state, the user pressed the “Enter” key with the non-dominant hand, the experiment started, the target appeared and the time was being recorded. When the stylus was in the other target area and in the tracking state, multimodal feedback alerted the user, the user pressed the “Enter” key and the trial ended. Visual, audio and tactile modalities, both individual and combined, were used for feedback. The types of these multimodal feedbacks were the same as those used in the first experiment. Subjects must keep the stylus’ tip on the tracking state all the time. If they fail, they are asked to do the trail again. The process and parameters of the experiment were the same as in Experiment 1.

3.5 Experiment 2: 2D Pointing Task

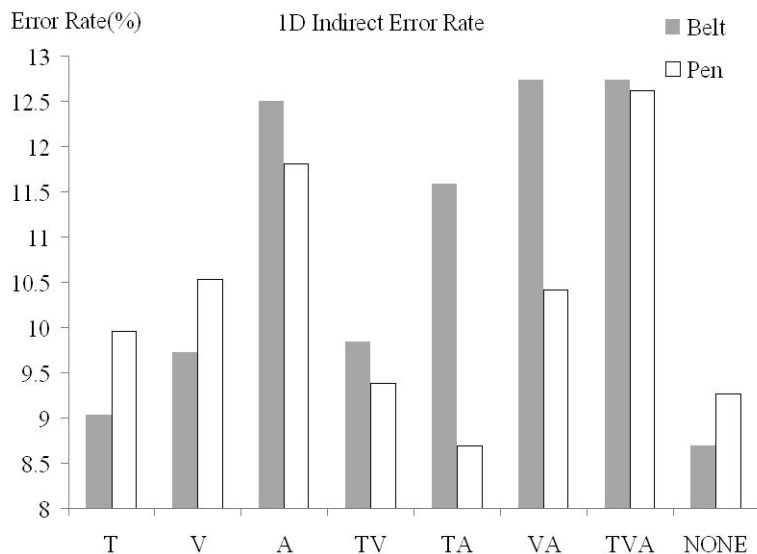

Fig. 3.8 Error rate by different feedback types with indirect input device in 1D pointing tasks.

3.5.4 Design

Independent variables were the width of the target ($W = 4, 8, 16$ and 32 pixels), distance between the two targets ($A = 100, 200, 300$ pixels), eight directions, input devices (direct and indirect), the motor attached at the stylus and another motor attached to the non-dominant hand with a belt and feedback type (no feedback (NONE), auditory (A), tactile (T), visual (V), auditory + visual (AV), visual + tactile (VT), auditory + tactile (AT), tactile+ visual + auditory (TVA)). The index of difficulty has 9 different values. For each trial, subject performed the task with all combinations of different conditions. The experiments were counterbalanced between participants. All of the independent variables, such as multimodal feedback type, tactile feedback (which hand), input devices, tunnel widths and tunnel amplitudes, were presented in random order. Because there are many independent variables and trails in this experiment, subject was asked to perform 3072 times per day at most. Totally it took each subject 3 hours to do the entire experiment.

3.5 Experiment 2: 2D Pointing Task

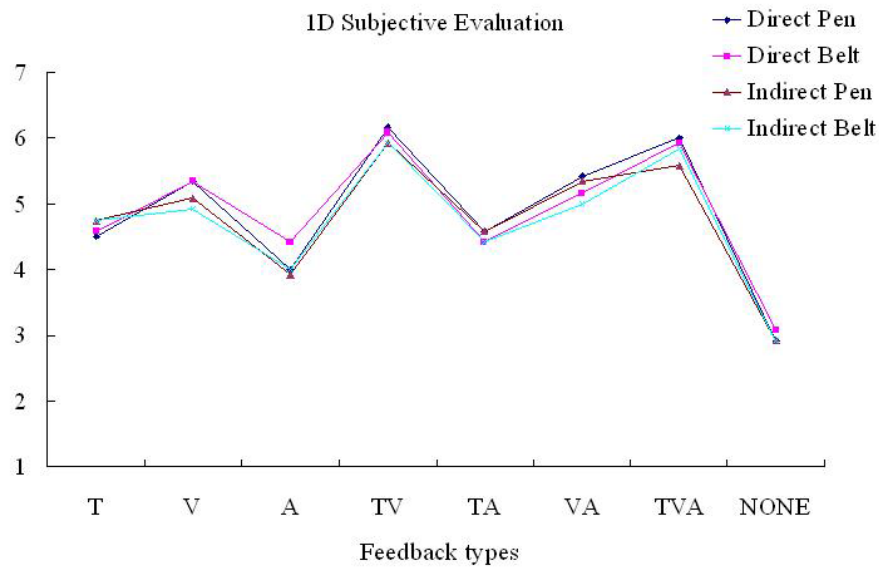

Fig. 3.9 Subjective evaluation in 1D pointing tasks.

In summary, the experiment consisted of:

- 12 participants ×
- 8 feedback types ×
- 4 target widths ×
- 2 trials ×
- 8 directions ×
- 3 distance between targets ×
- 2 types of input devices ×
- 2 different hands ×
- = 73728 times in total.

3.5.5 Hypotheses

- H7. Feedback types will affect movement time in 2D pointing tasks (tracking state).
- H8. Feedback types will affect error rate in 2D pointing tasks (tracking state).
- H9. Types of input devices will affect movement time in 2D pointing tasks (tracking

3.5 Experiment 2: 2D Pointing Task

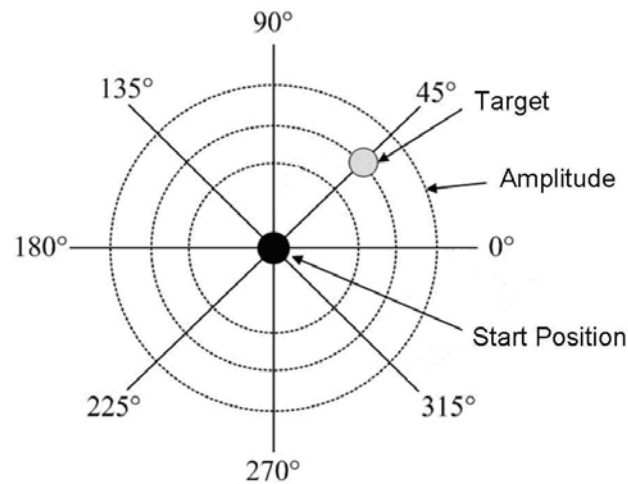

Fig. 3.10 The 2D pointing tasks.

state).

H10. Types of input devices will affect error rate in 2D pointing tasks (tracking state).

H11. Different hands will not affect movement time in 2D pointing tasks (tracking state).

H12. Different hands will affect error rate in 2D pointing tasks (tracking state).

3.5.6 Results

Movement Time (MT)

A repeated-measure ANOVA showed a significant effect for feedback type ($F_{7,77} = 7.787, p = 0$) on movement time, thus confirming hypothesis H7. Subjects with audio feedback spent the shortest movement time while with tactile feedback they spent the longest movement time. In contrast to H9, there was no significant effect for types of input devices ($F_{1,11} = 0.269, p = 0.615$) (see Fig.3.12 and Fig.3.13). There was no

3.5 Experiment 2: 2D Pointing Task

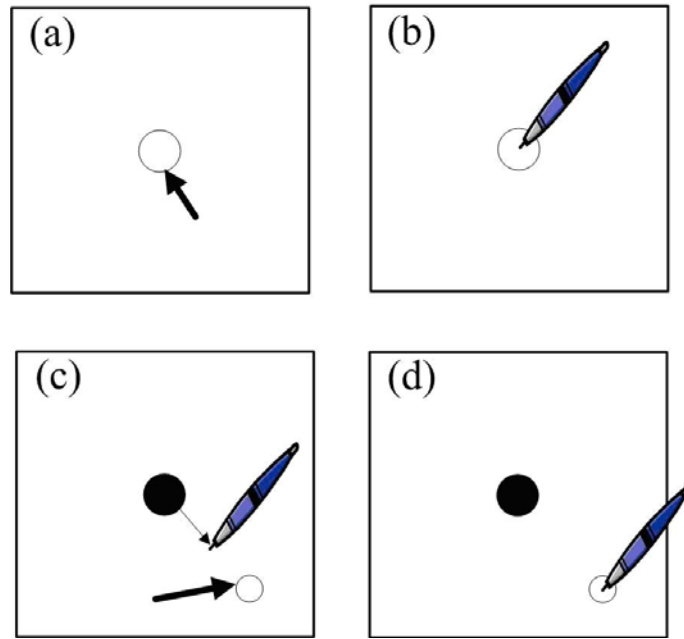

Fig. 3.11 The Process of 2D pointing task in tracking state.

significant effect for different hands ($F_{1,11} = 0.199, p = 0.665$) on movement time, thus confirming H11. The regression analyses on MT and ID indicated that they followed a linear relationship in each experiment, as predicted by Fitts' law (all $R^2 > 0.90$).

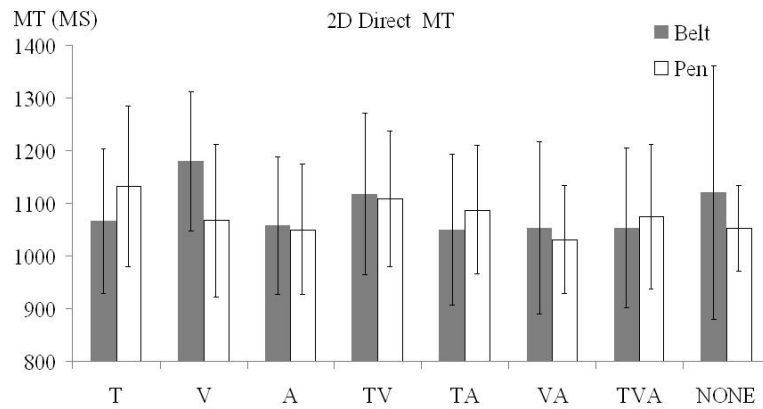

Fig. 3.12 Mean MT by different feedback type with direct input device in 2D pointing tasks. (Error bars represent 95% confidence interval)

3.5 Experiment 2: 2D Pointing Task

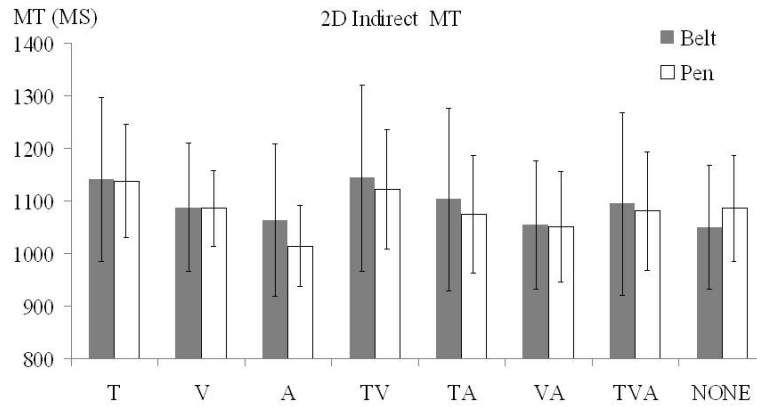

Fig. 3.13 Mean MT by different feedback type with indirect input device in 2D pointing tasks. (Error bars represent 95% confidence interval)

Error Rate

A repeated-measure ANOVA showed a significant effect for input device type ($F_{1,11} = 65.869, p = 0$) on error rate. When all experiments are averaged, the error rate of indirect input (see Fig.3.15) was 40.3% more than that of direct input (see Fig.3.14), thus confirming hypothesis H10. There was a significant effect for feedback type ($F_{7,77} = 2.393, p = 0.029$), thus confirming hypothesis H8. TV produced the lowest error rate while audio feedback produced the highest error rate. In contrast to H12, there was no significant effect for different hands ($F_{1,11} = 0.042, p = 0.841$).

Subjective Evaluation

The results showed that there was no significant effect for all parameters on fatigue. Most subjects preferred the TV feedback (see Fig.3.16).

3.6 Discussion

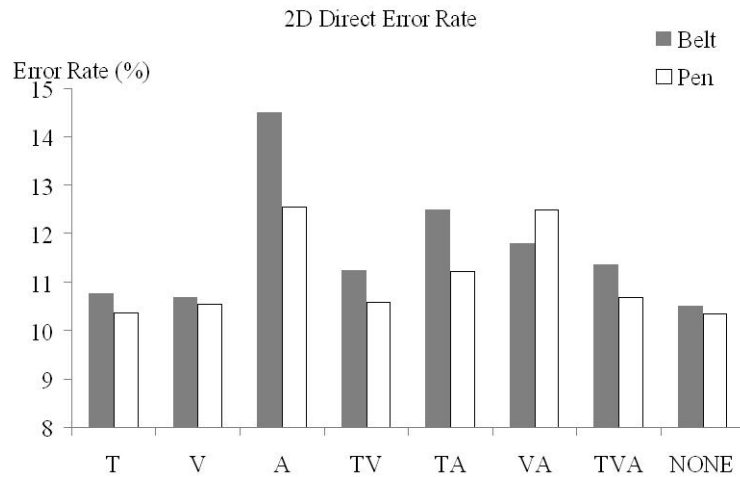

Fig. 3.14 Error rate by different feedback types with direct input device in 2D pointing tasks.

3.6 Discussion

The tracking state, which increases the bandwidth of HCI, is an important state in pen-based interaction. We designed two controlled experiments to investigate with which multimodal feedback type users can get the best performance.

From (Table 3.1), we can see that there was a significant effect for feedback type on error rate in 1D task, movement time and error rate in 2D task. Results showed tactile plus visual feedback was the best feedback among these multimodal feedback in tracking state. Input devices affected error rate and movement time in 1D task, error rate in 2D task significantly. Direct input method was much faster and more secret than indirect input method. The choice of hand (used for detecting feedback vibrations) affected neither the error rate nor movement time in 1D and 2D tasks significantly.

Experimental results and subjective evaluations showed that although tactile feedback did not decrease the movement time, it decreased the error rate and served as an alert to the user. Most of the participants preferred TV feedback. It can be explained

3.6 Discussion

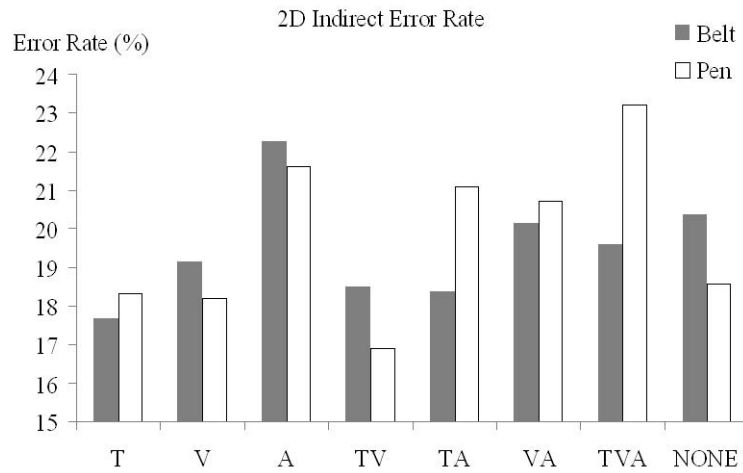

Fig. 3.15 Error rate by different feedback types with indirect input device in 2D pointing tasks.

Table 3.1 The results of two experiments. (Y means there is a significant effect on variable; N means there is no significant effect on variable.)

		Feedback types	Input devices	Different hands
1D	MT	N	Y	N
1D	Error rate	Y	Y	N
2D	MT	Y	N	N
2D	Error rate	Y	Y	N

here. In tracking state, the problem was how to avoid occlusion and alert user as quickly as possible. Tactile modality has many properties. For example, silent characteristic, every part of body can be applied with haptic, quick response, secrecy characteristic and so on. Therefore, tactile feedback can cover the drawbacks of visual feedback.

Although different hands did not affect movement time or error rate, the motor mounted on the stylus might change the trajectory of the stylus' tip when it is triggered,

3.6 Discussion

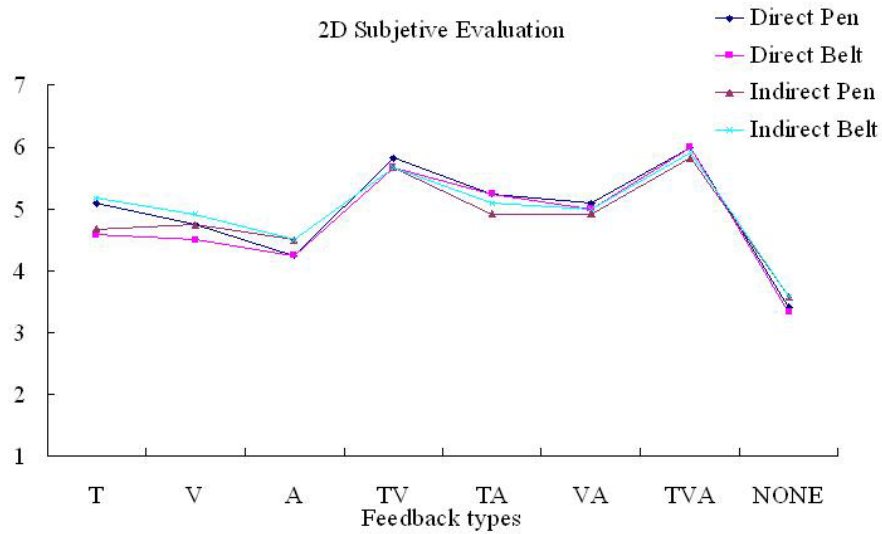

Fig. 3.16 Subjective evaluation in 2D pointing tasks.

especially when the input voltage of the motor is not appropriate. So we suggested that the feedback and input device should be applied to different hands. In the first experiment, the results showed that audio feedback (either by itself or in combination with tactile and visual) produced the highest error rate with the same movement time as other feedback. In the second experiment, we observed that subjects with audio feedback spent the shortest movement time to finish the task. However, the audio feedback produced the highest error rate. In summary, although the audio feedback can improve the movement time, the performance with the audio feedback is not good. So it is not efficient to use audio to give user feedback.

Our experimental results indicated that the direct input device outperformed the indirect input device in both error rate and movement time. This was different from the result of the pointing experiment designed by Forlines and Balakrishnan [30]. This phenomenon may be explained from the following points. After pointing to the first target, if the tip of the stylus was out of the tracking state, the position of the cursor was different between different devices when approaching the other target. The position

3.6 Discussion

of the cursor did not change with the indirect input device while it was random with the direct input device. Most of the subjects decided to finish the pointing task with the stylus in the tracking state all the time. We also asked the subjects to do the pointing tasks in the tracking state. The movement distance in the direct input device was longer than the distance in the indirect device for the same task. However, it was much more difficult to remain in the tracking state with the indirect input device than it was with the direct input device. When using indirect device, user should divide their attentions into two parts, getting visual feedback from display and maintaining the tracking state with the tablet. It is much harder than direct input device. Compared with direct input device, user should move the stylus more carefully and focus on the position change of cursor due to the control-display gain (CD) with the indirect input device. This resulted in an increased error rate and movement time. In summary, we believe that the tracking state is more suitable for direct input devices.

The movement time in the 2D experiment is longer than in the 1D experiment. The difference in movement time in the 2D pointing experiment with different input devices (direct or indirect devices) is smaller than that for the 1D pointing experiments. This proved that 2D tasks were more difficult than 1D tasks. Contrasted with the 1D task, there is no significant difference between direct and indirect devices in the 2D task. This may explain the different results from 1D and 2D experiments (Table 3.1).

The results of the experiments provided several guidelines for the design of feedback in tracking state:

(1) Tactile feedback plus suitable visual feedback can improve users' performance in tracking state.

(2) Design in tracking state is suitable for direct input device.

(3) Tactile feedback should avoid supplying with the same hand of input.

(4) Compared with other feedback, audio is not efficient to give user feedback in

3.6 Discussion

the tracking state.

We also proved that each of the conditions of the pointing task in the tracking state matched Fitts' law with correlations greater than 0.90. There is no study proved the Fitts' law in tracking state before. This study addressed an empty area in this field.

As an empirical evaluation study, these experiments had limitations. For example, due to the devices limitation, the devices in two experiments were different. However, the different feedback were compared in the same condition. In this part, we studied multimodal feedback in tracking state with subjects of university students. In the future, we want to investigate the effects of age and gender on the conclusion.

3.6 Discussion

This is a blank page.

Chapter 4

An Investigation of the Relationship between Texture and Human Performance in Steering Tasks

4.1 Introduction

With the development of complex computer rendering technologies, widgets and controlling interfaces are now often featured as multi-dimensional objects with sophisticated textures and physical properties. However, the manipulation of those objects is still constrained by the same controlling interfaces, making it difficult for users to feel the physical features of widgets in the real world. Texture is passive haptic feedback, as explored in [18, 49], with many properties, (e.g., roughness, hardness, stickiness, thermal conductivity). Nowadays, there are many input devices, from traditional mouse to pen-based devices such as tablet PC, PDA, mobile phone, and touch-based devices such as Microsoft Surface, Apple iPhone. Different displays or surfaces (even human skin) have different textures. We can imagine high-resolution texture display will be designed and widely used in the near future. Harrison and Hudson [36] used actuator to adjust the textures of six materials and proposed different displays with textures. Re-

4.2 Related Work

sults showed that user could recognize 2-4 different textures of each display. However, there is no study illustrating the relationship between texture and user performance and satisfaction in HCI tasks.

Many tablet users complain that tablet is too slippery for writing characters or draw pictures. In order to avoid the discomfort, some of them put a paper upon the surface of tablet. With this additional media, users can simulate the touch of writing or drawing on the paper. On the other hand, users may have different performances with different textures of devices. Imagine that you walk from place A to place B, and the distance between A and B is S. Compare the movement times when you walk on the ice and when you walk on the asphalt road. Obviously, the time for walking on the ice is much longer than one walking on the asphalt road. People can walk due to the ground friction. When people walk on the ice, they tend to or do slip since coefficient of friction is very small even to zero as well as friction is nearly zero. In this study, we asked how this situation can affect the performance in steering tasks. Although we did have different experiences in writing characters with different texture surfaces, there is no study to investigate the relationship between texture and user performance and satisfaction. In this chapter, we provide insight into this question and design an experimental study to investigate this relationship.

4.2 Related Work

The steering law is derived from crossing law whose recursion is the same as the Fitts' Law [27], that is $MT = a + b \log_2 (A/W + 1)$, Where MT is the movement time to cross through the tunnel, a and b are constants by devices, A is the path amplitude and W is the path width. Accot and Zhai [1] divided a tunnel into N parts. The steering task is composed by N parts of crossing tasks when N tends to infinity. Steering law

4.3 Experiment

$MT=a+ b(A/W)$ was proposed in that study.

There are several studies to include force factors into the steering law. Yang et al. [99] proposed a new haptic-steering model $MT=a+ b (A/(W+\eta \times S))$, where η is a constant determined by the intensity of guiding force, to predict movement time for steering task with guiding force. Results showed the model was more accurate than the traditional one for predicting performance times with force. The effects of stiffness and control gain on user performance were investigated for elastic devices by Casiez and Vogel [15]. Results showed that control gain affected error rate and movement time significantly but there was no significant effect for stiffness on user performance. There has not been study that investigated texture effect in steering tasks.

4.3 Experiment

4.3.1 Participants

Twelve right-handed university volunteers (9 males, 3 females, aged from 23 to 34 years) participated in the experiment. All participants had normal or corrected to normal vision. All of them had previous experience using a stylus and had medium to expert level computer experience.

4.3.2 Apparatus

Hollins et al. [42] chose 17 tactile stimuli to show subject mapped their judgments of texture into perceptual dimension. We selected materials based on this literature. However, even for the same material, different objects may have different textures. In this study, we compared five materials, Wacom tablet (tablet), A4 paper on top of the Wacom tablet (Paper), plastic sheet on top of the Wacom tablet (Plastic), imposing several A4 papers between plastic sheet and Wacom tablet (Soft plastic), and hard

4.3 Experiment

plastic cover on top of the Wacom tablet (Hard cover) (see Fig.4.1).

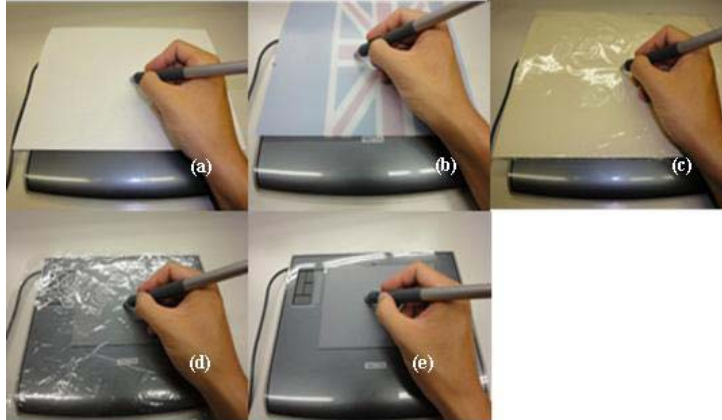

Fig. 4.1 (a) Paper. (b) Hard cover. (c) Soft plastic. (d) Plastic. (e) Tablet.

The experiment was conducted on a 2.13GHz Intel Core2 CPU PC with Windows XP. A 17-inch 1024×768 monitor and Wacom inuos3 PTZ-431W connected to PC. This Wacom tablet can detect the pressure with 1024 different levels corresponding to 0 - 4 Newton. The experimental software was developed with Java 6.0. In order to evaluate whether these five materials affected the accuracy and response time of Wacom tablet, we did a pilot study before the experiment. In pilot study, tracing task was designed to evaluate accuracy and pointing task was to test response time. Results showed that both accuracy and response time were not affected by these materials.

Measurement of Coefficients of Friction

Since dynamic friction played a major role in the whole process of steering task, we used weight ratio method, which was the normal method measure the dynamic friction of all materials. The coefficients of dynamic friction were shown in Table 4.1.

4.3 Experiment

Table 4.1 The coefficients of dynamic friction

Materials	Hard cover	Plastic	Tablet	Soft plastic	Paper
Coefficient of friction	0.081	0.126	0.153	0.233	0.295

Subjective Evaluation before the Experiment

There are also several factors which affect the friction such as softness, pressure, speed, human factor and so on. The purpose of this measurement is to explore whether subjects can distinguish different textures among these five materials with stylus. Participants with normal touch sense, seated in front of a desk. The subjects were asked to complete the experiment with their hand in a box to prevent participants using visual feedback to distinct the different materials. Each subject estimated the roughness and smoothness of five surfaces with stylus. We used Thurstone paired comparison method [90] and designed the experiment to compare each two materials in each trial. There were 10 trails in this experiment.

After each trail, each participant was asked. “Which material was much smoother?” and “Which material was softer?” If they could not distinguish from each other, they should answer “same”. The result showed the sequence from the smoothest to the roughest was plastic, tablet, hard cover, soft plastic and paper. The sequence from the softest to the hardest was soft plastic, paper, plastic, hard cover and tablet. The sequence of real smoothness was not the same as the one of subjective evaluation. The reason of this maybe if the difference is not big and the coefficient value is not much enough, they consistently perceived it differently.

4.3 Experiment

4.3.3 Task and Procedure

A circular steering tasks (Fig.2.2) was used in this study. The direction of the circular steering task was always clockwise. Each experimental trial started after the cursor crossed the start line and ended with crossing the end line. Both start line and end line must be successfully crossed otherwise the trial failed. Participants were asked to move the cursor inside the tunnel and they should finish the task as quick and accurately as possible. If the cursor was out of the tunnel, an error feedback with the color change of trajectory was triggered to warn participants. *MT* (movement time taken to move from the start line to the end line), *SD* (standard deviation of the distances between trajectory points and the center of the circular tunnel) and average pressure from the stylus' tip (detected by Wacom stylus) were measured in each trial. Before the experiment, the task was explained to the participants and they were asked to perform some warm-up trials until they were familiar with both the steering task and the different material types. They were asked to have a rest between blocks.

4.3.4 Design

We used a fully crossed within-subject factorial design. The independent variables were: *tunnel width* *W* (15, 30, 45 and 60 pixels), *tunnel amplitude* *A* (300, 450, 600, and 750 pixels), and *material type* (Paper, Hard cover, Plastic, Soft plastic and Tablet), *3 blocks*. The presentation orders of the material types were counterbalanced across participants. The five different materials were taped on the top of Wacom tablet.

All participants conducted the experiment in sitting postures. Within each *material type*, the participant performed all combinations of *tunnel widths* and *tunnel amplitudes* presented in random order, each for 3 trials. In summary, the experiment consisted of:

4.3 Experiment

8 participants ×
5 material types ×
4 tunnel widths ×
3 trials ×
4 tunnel amplitudes ×
3 blocks
= 5760 times in total.

The experiment took approximately 40 minutes per participant. After the experiment, participants completed a questionnaire to rate their subjective preferences for the material types.

4.3.5 Hypotheses

H1. Different material type affects movement time significantly.

H2. Under the same amount of movement time in a steering task, the lower coefficient of friction, the more accurate users perform.

4.3.6 Results

After analyzing the data, we found when the index of difficulty ($ID = A/W$) was higher, some participants could not finish the task correctly. Based on Accot and Zhai [1], if the cursor was out of the tunnel, the task was not the steering task any more. Therefore, we removed the part of data. 88% percentage of trials was successful. Finally, 8 participants' data were used to analyze in this study.

4.3 Experiment

Movement Time (MT)

In contrast to H1, a repeated-measure ANOVA showed that there was no significant main effect for material types ($F_{4,28} = 2.296, p = 0.084$). This meant that the average speed that user performed the task was almost the same. As showed in Fig.4.2, the overall average movement time was 2051 ms.

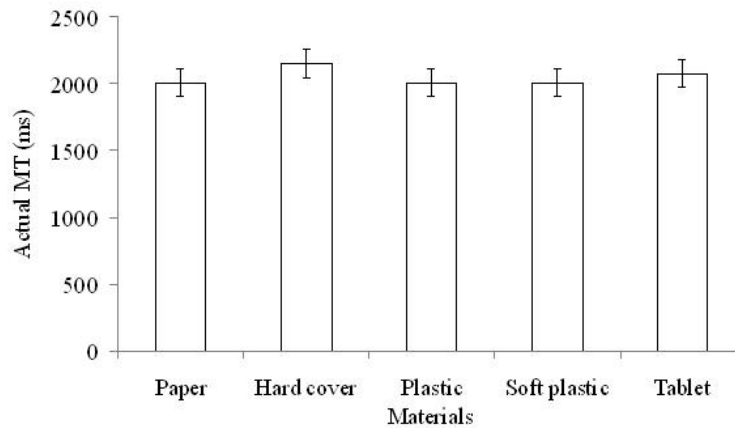

Fig. 4.2 Mean MT by different material types (Error bars represent 95% confidence interval).

Error Rate

A repeated-measure ANOVA showed there was a significant main effect for material types ($F_{4,28} = 8.859, p = 0.001$). As Fig.4.3 illustrated, the sequence from the biggest SD to shortest SD was plastic, tablet, hard cover, paper and soft plastic, thus confirming hypothesis H2. An interesting phenomenon was that the subjective smoothness sequence was almost the same as this SD sequence (except the soft plastic). It showed that, within the range of coefficients of friction, the smoother the surface is, the more error trajectory user performs.

4.3 Experiment

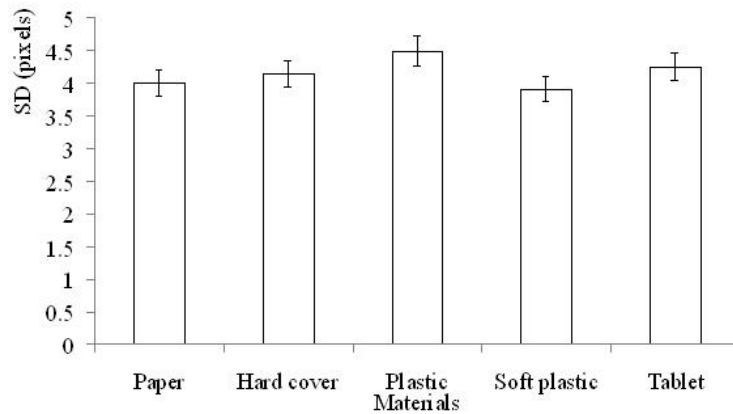

Fig. 4.3 Mean SD by different material types (Error bars represent 95% confidence interval).

Pressure

A repeated-measure ANOVA showed there was a significant main effect for material types ($F_{4,28} = 3.681, p = 0.016$). As Fig.4.4 illustrated, the sequence from the biggest pressure to lightest pressure was hard cover, paper, tablet, soft plastic and plastic. This showed another interesting phenomenon that each participant may use different forces to do steering task. It can be explained as such: each participant has a different comprehension of the task demand [102] which they should finish task as fast and accurately as possible. When there were several different textures, participants tried to keep the speed and accuracy as they thought. So they dynamically adjusted their behavior and their forces to suit the texture. Subjective bias played a role in it and covered the effect of texture. This also maybe the reason why there was no significant effect on from material types on MT.

4.3 Experiment

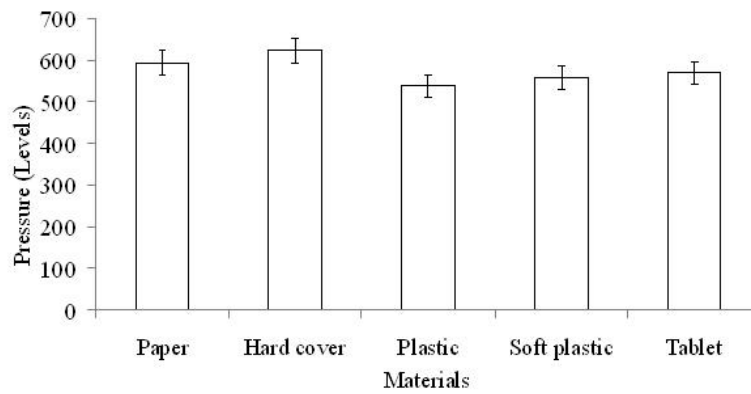

Fig. 4.4 Mean pressure by different material types (Error bars represent 95% confidence interval).

Steering Law Analysis

A linear regression of MT by ID for each material was summarized in Table 4.2. The results of linear regression for each materials suggested the information capabilities (described by $1/b$) [100] of same devices with different texture surfaces were almost the same.

Table 4.2 Steering Law regression values for material types.

Materials	a (ms)	b (ms/bit)	R^2
Paper	23.85	125.54	0.992
Hard cover	152.65	126.97	0.994
Plastic	132.23	125.37	0.996
Soft plastic	140.87	119.47	0.991
Tablet	123.27	128.58	0.997

4.4 Discussion

Subjective Evaluation

We used two dimensions which were ease-of-use and accuracy to evaluate the five materials subjectively. Participants were asked to rate these materials using a 7 point Likert scale (7 for best, and 1 for worst). As showed in Fig.4.5, most of participants liked paper and disliked plastic. Most of them reported “It is comfortable to steer on the paper” and it is the “natural” material suitable for stylus. Someone said that “plastic is too slippery for me and I can’t have precise control over the stylus”.

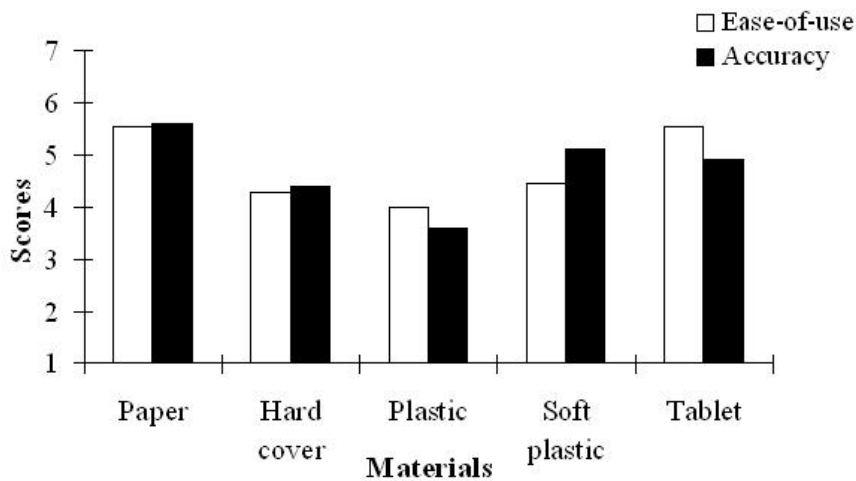

Fig. 4.5 Subjective evaluation of ease-of-use and accuracy.

4.4 Discussion

Haptics is one of the people’s modality has been investigated and exploited in human-computer interaction. Due to the limit of the hardware which produces haptic feedback, most of the haptic feedback are vibration (supplied with motor) and force feedback (supplied with Phantom [70], Cyberglove [20]). Texture as passive feedback reveals the status of target and increases the interaction information. This factor plays a significant effect on pen-based interface. This study contributes to investigating the

4.4 Discussion

effect of texture in steering task at the first time.

The movement time results indicated that texture did not affect the time significantly as hypothesis 1. One of the potential reasons is that circle steering task is not sensitive to detect the relationship between movement time and the friction of materials. In the further work, we will use different tasks to explore the effect of texture. Another potential reason is that users dynamically changed their forces to suit different textures with the task demand that user should perform the task as fast and accurate as possible. In order to get the larger anti-friction force to assist movement, users have to apply harder force to tablet and therefore movement time is delayed.

The accuracy results showed that texture had a significant main effect on standard deviation which was a symbol of accuracy. Under the same amount of movement time in a steering task, the lower coefficient of friction, the more accurate users perform. Discussed with pressure together, the harder user applies the force, the more accurate users perform. For the slippery material, user controlled the pen actively with harder force. However, for the rough material, user had to reduce the force and reduce the friction. The movement of pen was much more affected with rough material than the one with slippery material. Therefore, the trajectory with slippery surface was much more accurate.

All results of experiments showed that the relationship between MT and ID obeyed the steering law. The changes of constant a and b revealed the adjustments of different materials. Subjective evaluation showed that most of users preferred paper and dislike plastic. We observed that, in the pilot study of subjective evaluation, the sequence from the smoothest to the roughest was plastic, tablet, hard cover, soft plastic and paper. It means that most of users preferred rough material but disliked slippery material. It can be explained that user has to use harder force and will be fatigue with slippery material. Another potential reason is paper has long been familiar with users. This

4.4 Discussion

long and natural knowledge leads this result. This research investigates the effect of texture in steering tasks. As information communicating between human and computer increases, it is critical that we explore and apply different modalities of human being into interactive interfaces. This work gives a basic understanding of this kind of haptic feedback. Gesture has been studied for a long time. In the future, we also want to use the gesture tasks to investigate the effect of different textures.

4.4 Discussion

This is a blank page.

Chapter 5

Interaction Techniques with Personal User Input Modalities for Natural Pen-based Interfaces

5.1 Introduction

With the development of techniques, there are many input device now. From traditional mouse to Microsoft surface, smart phone, game controller (Wii), webCam and so on. However, the way of mode switch is still the same. User should select tool firstly and then input. If the task is complex, user has to switch among different tools frequently (for example, artist scenario). As also mentioned by Jun and Eduardo [77], mode switch becomes more time-consuming and causes tired arms with the increase of screen size.

It has been a long time for people to dream have a “to be anything” tool. Monkey King is a mythologized character in the classical Chinese epic novel Journey to the West. He protected monk Xuan zang’s pilgrimage to India. He has many fighting abilities and owns many tools. One of tools is Golden-banded staff. It can multiply, transform, and act intelligently. Everyone dreams to have same tool like that.

5.1 Introduction

Many researchers used different techniques to build “rich-action” input devices. Toolstone [78] was proposed to select different tools by changing the way how they hold the toolStone with non-dominant hand. Visionwand [17] was a low-cost passive wand. Users can trigger different commands with changing the postures and gestures of Visionwand. All these two widgets are prototypes and need user to memory the one-to-one correspondence between command and the holding way. Since different people have different memory skills, it limits the applications of these techniques.

There are also many studies on the utilization of pen input parameters to expand the bandwidth in pen-based interfaces. Pressure [75, 76], tilting [69, 95, 97], rolling [10, 86], hover state [33] are investigated. However, the purpose of them is to use the properties to be an additional input channel and enhance pen input. It takes time for user to learn or be familiar with those techniques. In this study, we used multi-touch pen (MTpen) with a capacitive sensor around the digital pen. Different grasp and gesture which is natural for user can be recognized with MTpen and are used to select different tools.

In this real drawing or writing tasks, when people use the pen, different people (age, gender, nationality, and other factors) have different ways to write or draw with pen. Everyone has their personal and unique holding ways and angles. Several literature reviews [28, 81] showed that drawing and tablet rotation were subconscious activities and people often adjusted the tilt and orientation of tablet. The distance between tablet and stylus was also discussed in this part.

Note that our study does not focus on the techniques or input modalities. Our interest is in the natural input in the real scenario. In this study, we use the MTpen to recognize grasp gestures and IMU to record angle information. And then use recognition-based method to do the model switching naturally and uniquely with all the input dimensions of input devices, both pen and tablet. Finally we explore the natural

5.2 Related work

interaction techniques and implement several tools, which all are long, thin, rounded shape, in artist scenario.

The rest of this part is organized as follows. We first re-view related work, and then describe a preliminary user inquiry. Based on the observations from this user inquiry, we then show how our system is designed. Afterward, we outline the user study tasks that were conducted to evaluate our system. Finally, we discuss findings that can be generalized to other designs, as well as future work.

5.2 Related work

There are several input dimensions in pen-based interfaces. Here we category them into two parts. The first is to apply pen input parameters in human computer interaction. The second one is work about input panel, such as tablet, the surface of PDA and smart phone.

5.2.1 Additional Input Channels on Stylus

There are many additional input modalities proposed to expand the human-computer interaction bandwidth in pen-based interfaces without the keyboard and mouse. Ramos et al. [75] designed an experiment to investigate human ability of controlling pressure. The result showed that 6 levels was optimal choice in the usage of pressure technique. Pressure marks [76] and Zliding [75] used pressure variations to assist selection and action efficiently. Bi et al. [10] explored incidental pen rolling and user's control ability to control rolling. The results suggested 10 degrees rolling could be used in mode switch and rolling speed should also be considered in rolling-based interaction techniques. The Rockin'Mouse [8] is a promising device for both 2D and 3D interaction that uses tilt input to facilitate 3D manipulation on a plane. Tilt Menu [89] is imple-

5.2 Related work

mented by using 3D orientation information of pen devices for enhancing one-handed techniques.

Graspable recognized interface [88] has been investigated for a while. Hyunyoung et al. [43] prototyped a MTpen with a capacitive sensor which can detect grips and touch gestures. They also designed a crossing task to compare barrel button and two kinds of MTpen gestures. Results showed that the performance of mode switch with gestures in MTpen is much better than one with barrel button. However, the properties and potential are worth of deeply investigation, especially how combine all the properties of pen to increase recognition and explore interaction techniques in the real scenario.

5.2.2 Input Modalities on Input Panel (Canvas)

“Good paper orientation not only provides designers with articulation comfort, but also enhances quality of sketched curves.” [88]. Fitzmaurice et al. [28] investigated the range of orientation and tilt of tablet in drawing tasks. They found rotating the artwork while drawing is important and comfortable for user.

A flexible and interactive surface, FLUX [54], can track pen and finger input. It can be used as three different boards. However, there is no study to investigate the interaction technique with the angle of the tablet and the angle between tablet and stylus. We believe our study will encourage more researchers focus on this point.

Our literature reviews indicated that while many different input modalities in pen-based interfaces had been investigated, they were designed for expanding the bandwidth of interaction. In this part, natural interface worth to explore is the use of all the information (angle and grasp) which focused on the personal and unique posture and grasp in pen-based interfaces.

5.3 Interview Investigation

In order to explore factors in the real artist scenario, we interviewed an oil painter (see Fig.5.1). She has more than 20 years of oil painting experience and has more than 50 kinds of different oil brushes in her work room. Usually she uses 10 different brushes in one painting. The materials of brushes are pig hair, wolf hair and horse hair etc. The harder material is, the closer she holds the brush near the tip of brush. She reported the frequency of changing brushes (different color and different widths) was high.

We observed how she grasped the oil brush. Her left hand often is used to sustain right hand and keep stability when painting. Her left hand holds several brushes which are frequent to use. When she used narrow width of brush, the hold position is near the tip of the brush, and vice versa.



Fig. 5.1 The interview of oil painting.

Except different kinds of brushes, she also uses spatulas to mix colors and carbon sticks to sketch. The grasp and angle are different when she uses different tools. There are four different angles of her easel (see Fig.5.2). For her, she prefers 85 degree. The reason is that she can get the overview of the painting and avoid the influence of light. When she uses spatulas and carbon sticks, she is familiar to put the canvas on the table.

5.4 Interaction Techniques



Fig. 5.2 Four easel angles.

All of the observations from this interview motivated us to combine all information to assist computer to recognize which tools people want to use.

5.4 Interaction Techniques

Several interaction techniques and applications were implemented with MTpen and IMU sensors. We recognize that the tool and scenario user want to use. Fig.5.3 shows state transitions of interaction techniques. When user grasps the pen, system can recognize the tool user wants to use with grasp and angle information in State 1. User can adjust different grasp and stylus' angle to change different tools. Gestures can be applied to change the parameters of the tool, such as the width of pen and the pen color in State 2. They can also change tools as the same as State 1. When user chooses the tool, there are several hierarchical choices in State 3. For example, when users choose the flute, they can dynamically press or release holes in the body of stylus to change the pitch of the sound. A serial of dynamic input can be used to trigger a command.

5.4 Interaction Techniques

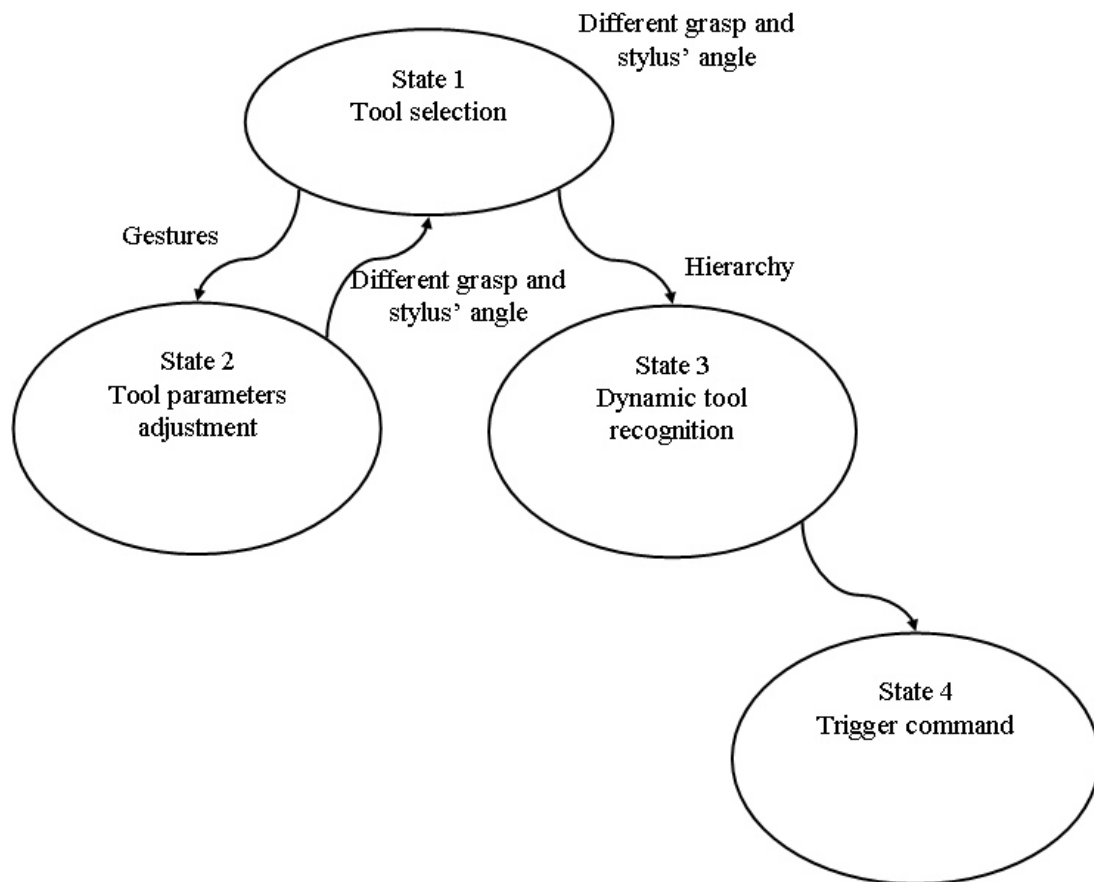

Fig. 5.3 State transitions of interaction techniques.

Applications of Tool Selection

Sketch pencil

The way of grasping a sketch pencil is very different from other tools (see Fig.5.4). This tool is often used in artist scenario.

Pen

Pen (see Fig.5.5) is one of the most normal tools in our lives. We can't change the width of ink by pressure sensor.

Chinese Calligraphy

Normally user should keep the Chinese brush vertically (see Fig.5.6). The width of ink stroke can be adjusted with pressure sensor.

5.4 Interaction Techniques



Fig. 5.4 Sketch pencil grip.



Fig. 5.5 Pen grip.

Compass

We can hold the end of stylus and use it as a compass see (Fig.5.7). The contact point between stylus tip and display surface is the center of circular arc. User can change the radius and length of circular arc by adjusting the raw (azimuth) and pitch of MTpen. When stylus' tip leaves the display surface, the circular arc will be drawn in the canvas.

Airbrush

We use the swipe gesture to trigger the buttons of airbrush (Fig.5.8).

5.4 Interaction Techniques

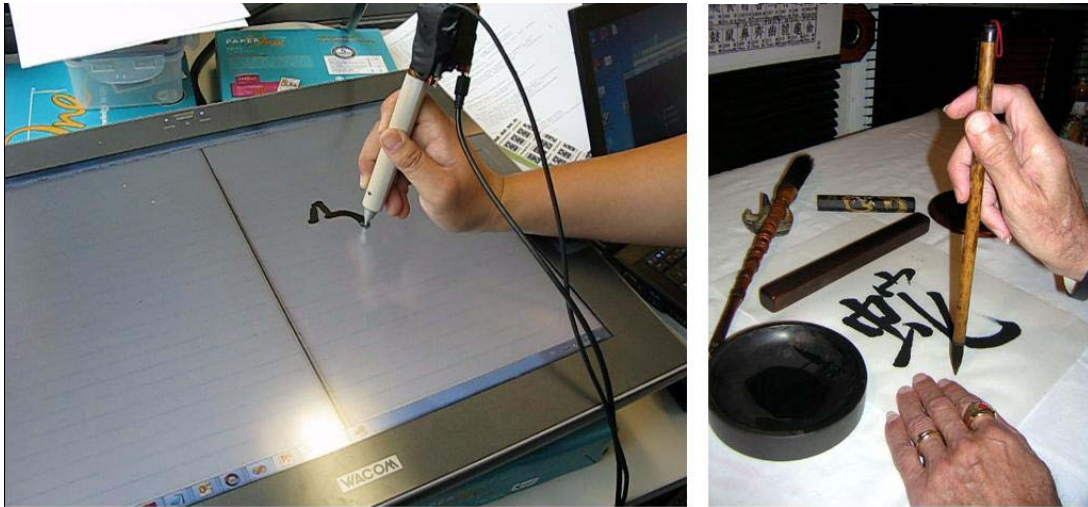

Fig. 5.6 Chinese calligraphy grip.

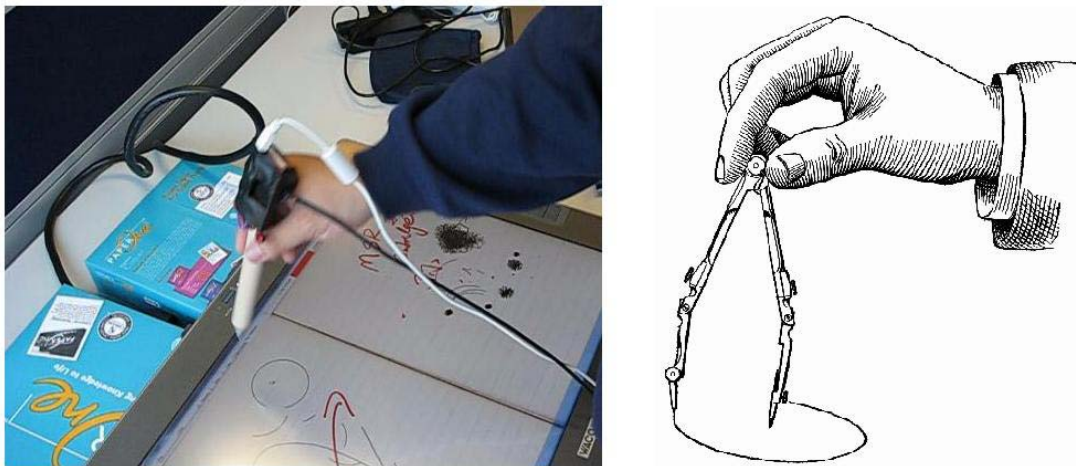

Fig. 5.7 Compass grip.

Eraser

Here we use it as white board eraser (Fig.5.9). The pitch is 0 degree.

Background Selection

Many researchers investigated user control of multi-touch using two hands (pen plus multi-touch input). Here we can explore multi-touch pen interaction using two

5.4 Interaction Techniques

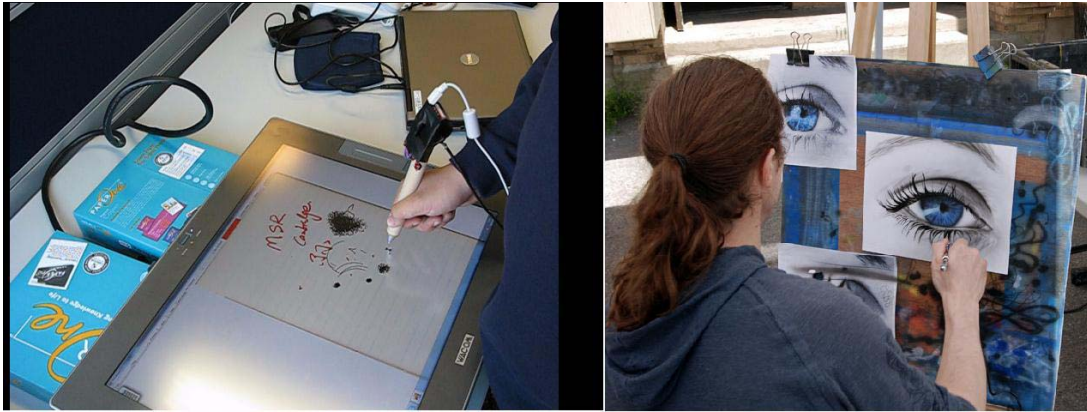

Fig. 5.8 Airbrush grip.

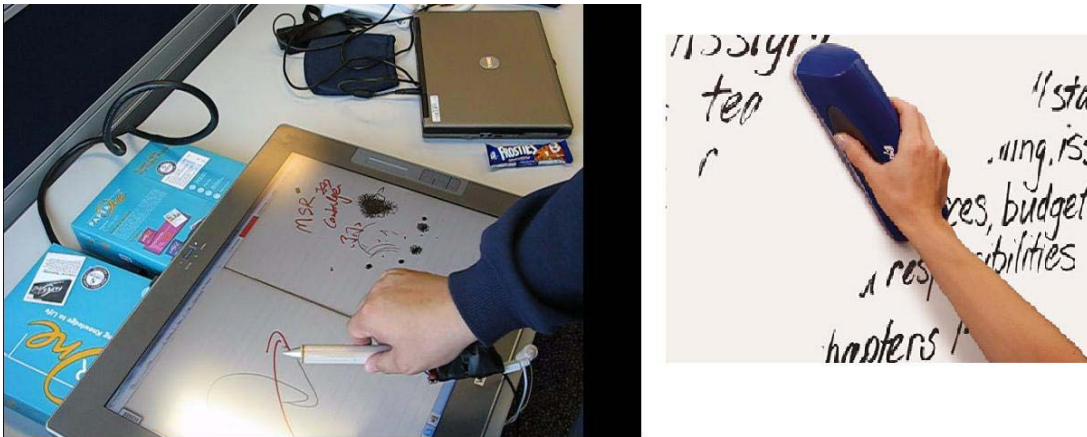

Fig. 5.9 Eraser grip.

hands (left hand holds a tablet [81], right hand holds an MTpen). This is the first time to explore this two-handed interaction. In this study, three different tablet angles are implemented. If horizontal tablet, the background is white-board. All of the tools are related to the whiteboard. If vertical tablet, the background is Chinese painting. If tablet is neither horizontal tablet nor vertical, the background is oil painting or sketch book.

5.5 System Implementation

Apparatus

IMU sensor (CHR-6dm AHRS) was paralleled mounted on the stylus and tablet. The angles (yaw, roll and pitch) of digital pen and tablet can be detected with IMU sensor. We use the hardware which was designed by [43]. It is a standard Wacom Intuos digital pen covered with a plastic cylindrical enclosure and a capacitive sensor. The length of the pen is 175mm and the diameter is 16mm.

The size of the capacitive sensor is 50mm \times 100mm which is roughly 2/3 of the pen (see Fig.5.10). Most parts of area where user holds the pen are covered with this snsor. We also use architectural velum to avoid direct electrical contact between user's fingers and the sensor. We can get a 20 \times 10 grid image from the sensor. When a user's finger is placed on the sensor, it affects the mutual capacitance between the sensing elements of nearby rows and columns which is detected by the microcontroller. The raw capacitive sensor values are converted into a 20 \times 10 grayscale image at 100Hz which is the raw data for recognition algorithm.

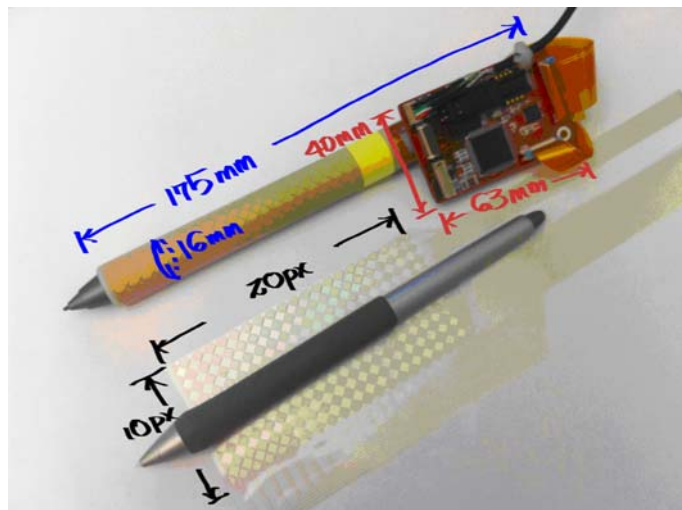

Fig. 5.10 Multi-touch pen hardware.

5.6 Discussion

Grip Recognition

We use k-Nearest Neighbor (KNN) algorithm [19] to compare the different contact sensor images, distances between tablet and stylus, stylus' angle information and tablet angles. Yaw angle is not used in our recognition algorithm because user always changes the twist angle with any tools. To increase the recognition rate, we processed the raw sensor image firstly. Raw sensor image was transferred by rolling angle. And then we blurred the image by a Gaussian function. We defined the distance between tablet and stylus into three states: dragging state, hover state and remote state. So the distance is discrete variety and all the other factors are continuous varieties.

In order to decrease the training data, we did not record the data until the difference between new image and recorded data was more than a threshold. The recognition rate for ten different grips was 85% based on the training data.

Our informal user studies showed that our recognition algorithm can recognize most of the tools subjects wanted to use. Some users reported they felt comfortable to change the tools with eye-free selection. Because some users have not used such digital pen before, they are not familiar with the size and feeling of pen. The grasp is different from they hold normally. It will be interest to compare the different grasps with digital pen and physical pen in the future work.

5.6 Discussion

As the strategy of tool selection, our system does not need the area to select tools in screen and saves area to draw. One of the most important properties of our system is that users do not need to memory all the commands. This property could be good for old people and children especially. Another property is personal and natural. Although it is the same grasp and gesture, different people uses it as different tools. For example,

5.6 Discussion

people from different countries, people with different dominant hand and different age or gender people. Based on these two properties of our system, it helps user to change the tools quickly and decreases the workload of tasks. In our system, users do not need to explicitly consider in which mode they are. Our system can recognize which tool they want to use with hand posture and angle information. All of the recognitions are implemented dynamically. Compared with VisionWand [17] implemented with computer vision technique, our system used capacitive sensor and did not have limit on the environment (lack of light).

In addition to the artist scenario, there are several scenarios in which using the pen-type also can use these interaction techniques. For example, most of the musical instruments are pen-type tools, such as flute and saxophone. We can use MTpen to simulate the flute and saxophone. Based on different grasp (with pressing down and up the finger holes) and angle information, different tools and syllables can be recognized. We can also define a series of syllables to trigger commands. In first personal shooting game (FPS), for example, in counter strikes, different weapons can be changed with these interaction techniques, such as knife, machine gun and pistol.

In our system, the purpose of this study is to ask computer recognize which tool user wants to use and hide the tool selection on the background. There are also several important dimensions which assist system to recognize user's expected tool can be applied into this system. First one is the distance between MTpen and tablet. There are three states in a pen operation (see Fig.3.1). Although the grasp and angle are the same, the distance can distinguish different tools. And also we can use distance information to increase the input bandwidth. Second one is the tilt angle of tablet and the angle between tablet and MTpen. In the real world, users display the tablet with different angles according to the comfortable usage or personal preference. For example, when using chalk, they display the blackboard and whiteboard vertically. They place the

5.6 Discussion

paper on the horizontal table when they draw Chinese painting or write characters with calligraphy, otherwise the ink would flow to other directions. When drawing oil painting and sketch, users put the paper or canvas on the artist easel which is fully adjustable to accommodate for the different angles artists need. All of these rich funds of context awareness can help system to recognize different tools much more correctly. A one-to-one correspondence between tilt angle of tablet and layout can be proposed. Third one is tablet orientation. According to the study of [28], there was a wide range of individual orientation differences when users were drawing, and user adjusted the orientation of artwork many times while drawing. We can also use the tablet orientation to assist tool recognition.

It enlarged the space of interaction techniques in natural. All the painting tools were triggered in dragging state. Other commands can be implemented in hover and remote states, such as flute, clarinet and pie menu. Our interaction techniques were applied with kinesthetic sensation and easily understandable. They obeyed all the principles for rich-action input devices proposed by [77]. The angles of MTpen and tablet will be also investigated in the future.

Chapter 6

General Conclusions and Contributions

The current pen-based interfaces have relied on Graphic user interface (GUI) for a long time. However, pen-based interfaces design has become increasingly challenging by the increase of information, different workload, security, physical limitation. In many scenarios, interaction with visual interface creates competition for different environments and different people. There is a trend to design the natural and efficient interface in pen-based interfaces. This dissertation explores how to use haptic modality which is both input and output modality of the human being. Vibration, texture and kinesthetic sensation are investigated.

This thesis contributes on the basic understanding of human performance (both in the pointing task and steering task) with haptic feedback in pen-based interfaces and investigation of relationship between texture and user performance. It also contributes on the interaction techniques with kinesthetic sensation for natural pen-based interfaces. In summary, it makes a contribution to the development of using haptics to expand the bandwidth between human and computer. In the following, we summary the contributions in details.

6.1 Effects of Multimodal Error Feedback on Human Performance in Steering Tasks

Contribution 1: Demonstration, through experimental results, that feedback significantly affects the accuracy of steering tasks but not the movement time. And users perform most accurately with tactile feedback in steering task. It contributes to the basic understanding of “error feedback” and how it impacts on steering tasks.

Contribution 2: Demonstration, through experimental results, that there is a significant main effect of feedback position on movement time. But there is no significant difference between three feedback positions in accuracy. Our findings suggest that vibration feedback should be applied outside of the trajectory as a warning signal. There are several different positions, inside the tunnel, outside of the tunnel and at the boundaries of tunnel, where designer can supply tactile feedback to the user. This part contributes to insights and implications for the future design of multimodal feedback mechanisms for steering tasks.

6.2 A Comparison of Multimodal Feedback in Pointing Task with Tracking State

Contribution 3: Quantitatively analyzing the multimodal Feedback in Pointing Task with Tracking State. We explored the use of multimodal (audio, tactile, visual) feedback for pen pointing tasks in the tracking (hover) state. We also report on the effectiveness of such feedback for pointing in 1D and 2D contexts, for direct and indirect inputs, and for different possibilities for tactile feedback.

In 1D pointing experiments, results show that there is a significant effect for input types on movement time while feedback type and the use of different hands for receiv-

6.3 An Investigation of the Relationship between Texture and Human Performance in Steering Tasks

ing feedback (i.e. the dominant or non-preferred hand) do not affect movement time significantly. (We report also that) there is a significant effect for feedback types and input device types on error rate while the choice of hand (used for detecting feedback vibrations) does not affect the error rate significantly. In the 2D pointing experiment, results show that there are no significant effects for either input type or the use of different hands on movement time while feedback type affects movement time significantly. Results for both the 1D and 2D pointing tasks show that tactile plus visual feedback can improve accuracy and audio is not efficient to give user feedback in tracking state.

Hover space is starting to be looked at seriously in the context of pen and even touch interfaces, the task of being able to point at an object in the tracking (hover) state is certainly a useful one to explore. This part contributes to the use of different types of multimodal feedback that can make the task more efficient and reduce errors. We propose several guidelines for feedback design in tracking state. We believe these results can aid designers of pen-based interfaces.

6.3 An Investigation of the Relationship between Texture and Human Performance in Steering Tasks

Contribution 4: This is the first time to evaluate the effect of surface environment especially for the texture of interaction surface. Demonstration, through experimental results, that the texture has no significant effect on movement time in steering task. The smoother the surface is, the more error trajectory user performs. Our evaluation also proved that different textures can affect user's satisfaction significantly.

6.4 Interaction Techniques with Personal User Input Modalities for Natural Pen-based Interfaces

Contribution 5: We propose a new natural user interface with kinesthetic which is to facilitate reducing the workload and memory of triggering commands. User can change the tools implicitly and all selection commands are triggered in the background. Many applications are developed with this natural interfaces in this part. This is the first time to consider the information of tablet's angle. The setup of tablet contains many potential information inside. We use this information to apply several applications.

This thesis investigates human performance with haptic sensations in pen-based interfaces. There are many different sensations in haptics. For example, pressure, texture, puncture, thermal properties, softness, wetness, vibrotactile sensations and so on. In the future study, we will apply more haptic sensations into pen-based interfaces and use the properties of these sensations into natural interface design.

Acknowledgement

First, I would like to thank my advisor Professor Xiangshi Ren, for his continuous support in my pursuing the Ph.D. degree. Professor Xiangshi Ren always provided me with insightful comments, demonstrated how research should be done, and discussed with me frequently. He taught me how to ask questions and express my ideas. He showed me different ways to approach a research problem and the need to be persistent to accomplish any goal.

Next, I am also very grateful to Professor Yoshio Inoue, Professor Kyoko Shibata, Professor Yoshiaki Takata and Professor Hiroaki Shigemasu for their insightful comments on my thesis. I also thank for other professors and two secretaries in the School of Information at KUT.

I'd like to thank members of the Ren lab in the Department of Information Systems Engineering, particularly Jibin Yin, Chuanyi Liu, Xiaolei Zhou, Yizhong Xin, Feng Wang, Huawei Tu and all Japanese students in Ren lab for their friendship and contributions to my work.

I have also been greatly honor to cooperate with researcher Xiang Cao at Microsoft Reserach and Assistant Professor Shengdong Zhao of National University at Singapore. I learned a lot from them. I look forward to collaborating with them in the near future.

I would like to thank my family members to support to my life all along. I love them forever.

I thank many people who give me a lot of help and encouragement. The list is a part of them and may be not exhaustive, and I apologize to anyone I didn't mentioned in this list.

I have received support in the form of scholarships (Special Scholarship Program)

Acknowledgement

and the Gakushu Shorei-hi Scholarship from Kochi University of Technology. This research would have been impossible without that generous supports.

References

- [1] Accot, J., and Zhai, S.: Beyond Fitts' Law: Models for Trajectory-Based HCI Tasks, *CHI 1997 Proceedings*, Atlanta, Georgia, ACM, Addison-Wesley, pp. 295–302 (1997).
- [2] Accot, J., and Zhai, S.: Performance evaluation of input devices in trajectory-based tasks: an application of the steering law, *CHI 1999 Proceedings*, Pittsburgh, Pennsylvania, ACM, Addison-Wesley, pp. 466–472 (1999).
- [3] Accot, J. and Zhai, S.: More than dotting the i's -foundations for crossing-based interfaces, *CHI 2002 Proceedings*, Minneapolis, Minnesota, ACM, Addison-Wesley, pp. 73–80 (2002).
- [4] Akamatsu, M., MacKenzie, S., and Hasbrouc, T.: A comparison of tactile, auditory, and visual feedback in a pointing task using a mouse-type device, *J. Ergonomics*, Vol. 38, No. 4, pp. 815–827 (1995).
- [5] Akamatsu, M., and MacKenzie, S.: Movement characteristics using a mouse with tactile and force feedback, *International Journal Human-Computer Studies*, Vol. 45, No. 4, pp. 483–493 (1996).
- [6] Apelle, S.: Haptic perception of form: activity and stimulus attributes, *The psychology of touch*, M. Heller and W. Schiff, Editors. Lawrence Erlbaum: Hillsdale, NJ (1991).
- [7] Avizzano, C. a, Solis, J., Frisoli, a, and Bergamasco, M.: Motor learning skill experiments using haptic interface capabilities. *Proceedings. 11th IEEE International Workshop on Robot and Human Interactive Communication*, pp. 198-203 (2002).
- [8] Balakrishnan, R., Baudel, T., Kurtenbach, G., Fitzmaurice, G., and East, R.S.: The Rockin Mouse : Integral 3D Manipulation on a Plane. *CHI 1997 Proceedings*,

References

- pp. 311-318 (1997).
- [9] Blasko, G., Beaver, W., Kamvar, M. and Feiner, S.: Workplane-orientation sensing techniques for tablet PCs, *UIST2004 Proceedings*, pp. 24-27 (2004).
- [10] Bi, X., Moscovich, T., Ramos, G., Balakrishnan, R., and Hinckley, K. An exploration of pen rolling for pen-based interaction. *UIST2008 Proceedings*, pp. 191-200 (2008).
- [11] Burke, J.L., Prewett, M.S., Gray, A.A., Yang, L., Stilson, F.R.B., and Coover, M.D.: Comparing the Effects of Visual-Auditory and Visual-Tactile Feedback on User Performance: A Meta-analysis, *8th International Conference on Multimodal Interfaces*, Banff, Canada, ACM, pp. 108–117 (2006).
- [12] Buxton, W.A.S.: A three-state model of graphical input, *Human-Computer Interaction*, pp. 449-456 (1990).
- [13] Buxton, W.: A three-state model of graphical input. *CHI 2006 Proceedings*, pp. 449-456 (2006).
- [14] Card, S. K., English, W. K., and Burr, B. J.: Evaluation of mouse, rate-controlled isometric joystick, step keys, and text keys for text selection on a CRT. *Ergonomics*, 21. pp. 601-613 (1978).
- [15] Casiez, G. and Vogel, D. The effect of spring stiffness and control gain with an elastic rate control pointing device. *CHI 2008 Proceedings*, ACM Press , pp. 1709-1718 (2008).
- [16] Campbell, C.S., Zhai, S., May, K.W., and Maglio, P.P.: What You Feel Must Be What You See: Adding Tactile Feedback to the Trackpoint, *INTERACT 1999 Proceedings*, Edinburgh, Scotland, IOS Press, pp. 383–390 (1999).
- [17] Cao, X., Balakrishnan, R.: VisionWand: Interaction techniques for large displays using a passive wand tracked in 3D. *UIST 2003 Proceedings*, pp. 193-202 (2003).
- [18] Cholewiak, R., Collins, A. Sensory and physiological bases of touch, *The psychology*

References

- of touch*, M. Heller and W. Schiff, Ed. Lawrence Erlbaum pp. 23-60 (1991).
- [19] Cover, T.M., Hart, P.E.: Nearest neighbor pattern classification, *IEEE Transactions on Information Theory*, 13 (1), pp. 21C27 (1967).
- [20] Cyberglove. <http://www.cyberglovesystems.com/>
- [21] Dennerlein, J. T., Martin, D. B., and Hasser, C.: Force-feedback improves performance for steering and combined steering-targeting tasks, *CHI 2000 Proceedings*, Hague, Netherlands, ACM, pp. 423–429 (2000).
- [22] Emery, V.K., Edwards, P.J., Jacko, J. a.: Toward achieving universal usability for older adults through multimodal feedback. *CUU 2003 Proceedings*, pp. 46, (2003).
- [23] Enriquez, M., Afonin, O., Yager, B., and MacLean, K.: A Pneumatic Tactile Alerting System for the Driving Environment, *ACM International Conference Proceeding Series*, pp. 1-7, (2001).
- [24] Enriquez, M., and MacLean, K.: Impact of Haptic Warning Signal Reliability in a Time-and-Safety- Critical Task, *proceedings of the 12th Annual Symposium on Haptic Interfaces for Virtual Environment and Teleoperator Systems*, pp. 407-417, (2004).
- [25] Epps, B. W.: Comparison of six cursor control devices based on Fitts' law models. *Proceedings of the Human Factors Society 30th Annual Meeting*, pp. 327-331(1986).
- [26] Fitts, P.M. and Seeger, C.M. S-R compatibility: spatial characteristics of stimulus and response codes. *Journal of Experimental Psychology*, 46. pp.199-210 (1953).
- [27] Fitts, P.M. The information capacity of the human motor system in controlling the amplitude of movement. *Journal of Experimental Psychology*. pp. 381-391 (1954).
- [28] Fitzmaurice, G.W., Balakrishnan, R., Kurtenbach, G., and Buxton, B. An exploration into supporting artwork orientation in the user interface. *CHI 1999 Proceedings* . pp. 167-174 (1999).
- [29] Fitzmaurice, G., Khan, A., Piek, R., Buxton, B., and Kurtenbach, G.: Tracking

References

- menus. *UIST 2003 Proceedings*, pp. 71-79, (2003).
- [30] Forlines, C., and Balakrishnan, R.: Evaluating tactile feedback and direct vs. indirect stylus input in pointing and crossing selection tasks, *CHI 2008 Proceedings*, Florence, Italy, ACM, Addison-Wesley, pp. 1563-1572 (2008).
- [31] Gibson, S., Samosky, J., Mor, A.: Simulating Arthroscopic Knee Surgery using Volumetric Object Representations , Real-Time Volume Rendering and Haptic Feedback. *CVRMed-MRCAS '97 Proceedings*, pp. 88-90, (1997).
- [32] Griffith, P., and Gillespie, R.: Sharing Control Between Humans and Automation Using Haptic Interface: Primary and Secondary Task Performance Benefits, *The Journal of the Human Factors and Ergonomics Society*, vol. 47, no. 3, pp. 574-590, (2005).
- [33] Grossman, T., Hinckley, K., Baudisch, P., Agrawala, M., Balakrishnan, R., and Berkeley, U.C.: Hover Widgets : Using the Tracking State to Extend the Capabilities of Pen-Operated Devices. *CHI 2006 Proceedings*, pp. 861-870 (2006).
- [34] Guimbretire, F., Martin, A., and Winograd, T.: Benefits of merging command selection and direct manipulation. *ACM Transactions on Computer-Human Interaction*, pp. 460-476 (2005).
- [35] Harrison, B.L., Fishkin, K.P., Gujar, A., Mochon, C. and Want, R.: Squeeze me, hold me, tilt me! an exploration of manipulative user interfaces. *CHI 1998 Proceedings*, pp. 17-24 (1998).
- [36] Harrison, C. and Hudson, S. F. Texture displays: a passive approach to tactile presentation. *CHI 2009 Proceedings*, ACM Press (2009), pp. 2261-2264.
- [37] Hinckley, K., Baudisch, P., Ramos, G., and Guimbretiere, F.: Design and analysis of delimiters for selection-action pen gesture phrases in scriboli. *CHI 2005 Proceedings*, pp. 451-460 (2005).
- [38] Hinckley, K., Pierce, J., Sinclair, M., and Horvitz, E. Sensing techniques for mobile

References

- interaction. *UIST 2000 Proceedings*, pp. 91-100 (2000).
- [39] Hinckley, K., Ramos, G., Guimbretiere, F., Baudisch, P., and Smith, M.: Stitching : Pen Gestures that Span Multiple Displays. *AVI 2004 Proceedings* pp. 23-31 (2004).
- [40] Hoggan, E, Brewster, S.A. and Johnston, J. Investigating the Effectiveness of Tactile Feedback for Mobile Touchscreens. *CHI 2008 Proceedings* pp. 1573-1582 (2008).
- [41] Hoggan, E., Crossan, A., Brewster, S., and Kaaresoja, T.: Audio or Tactile Feedback : Which Modality When? *CHI 2009 Proceedings*, pp. 2-5 (2009).
- [42] Hollins, M., Faldowski, R., Rao, S., and Young, F. Perceptual dimensions of tactile surface texture: A multidimensional scaling analysis. *Perception and Psychophysics*, 54, pp. 697-705, (1993).
- [43] Hyunyoung, S., Benko, H., Guimbretiere, F., Izadi, S., Cao, X., and Hinckley, K.: Grips and gestures on a multi-touch pen. *To appear in CHI 2011 Proceedings*. , (2011).
- [44] Jacko, J.A., Barnard, L., Kongnakorn, T., Moloney, K.P., Edwards, P.J., Emery, V.K., and Sainfort, F.: Isolating the effects of visual impairment: exploring the effect of AMD on the utility of multimodal feedback, *CHI 2004 Proceedings*, Vienna, Austria, ACM, Addison-Wesley, pp. 311–318 (2004).
- [45] Jacko, J.A., Scott, I.U., Sainfort, F., Barnard, L., Edwards, P.J., Emery, V.K., Kongnakorn, T., Moloney, K.P. and Zorich, B.S.: Older adults and visual impairment: What do exposure times and accuracy tell us about performance gains associated with multimodal feedback? *CHI 2003 Proceedings*, Ft. Lauderdale, Florida, ACM, Addison-Wesley, pp. 33–40 (2003).
- [46] Kaaresoja, T., Brown, L. M. and Linjama, J. Snap- Crackle-Pop: Tactile Feedback for Mobile Touch Screens. *Eurohaptics 2006 Proceedings*, pp. 565 - 566 (2006).
- [47] Kattinakere, R.S., Grossman, T., and Subramanian, S.: Modeling steering within above-the-surface interaction layers. *CHI 2007 Proceedings* pp. 317 (2007).

References

- [48] Kantowitz, B. H., Elvers, G. C.: Fitts' law with an isometric controller: Effects of order of control and control-display gain. *Journal of Motor Behavior*, 20 pp. 53-66 (1988).
- [49] Klatzky, R., and Lederman, S. Tactile roughness perception with a rigid link interposed between skin and surface. *Perception and Psychophysics* , 61, pp. 591-607 (1999).
- [50] Klatzky, R. L., and Lederman, S. J.: Touch. *Handbook of Psychology*, pp. 147-176 (2003).
- [51] Kulikov, S., MacKenzie, I.S., and Stuerzlinger, W.: Measuring the effective parameters of steering motions, *CHI 2005 Proceedings*, Portland, OR, ACM, Addison-Wesley, pp. 1569–1572 (2004).
- [52] Kuroki, T. and Kawai, S.: An interface technology for pen devices using tilt information. *Proc. Interactive Systems and Software* , pp. 1-6 (1999).
- [53] Lee, C.J., H.P. Dietz, D. Leigh, S.W. Yerazunis, and E.S. Hudson.: Haptic pen: a tactile feedback stylus for touch screens, *UIST 2004 Proceedings*, Santa Fe, New Mexico, ACM, pp. 291–294 (2004).
- [54] Leitner, J., Powell, J., Brandl, P., Seifried, T., Haller, M., Dorray, B. and To, P. Flux: a tilting multi-touch and pen based surface. *CHI 2009 Proceedings*, pp. 3211-3216 (2009).
- [55] Li, Y., Hinckley, K., Guan, Z., and Landay, J. a.: Experimental analysis of mode switching techniques in pen-based user interfaces. *CHI 2005 Proceedings* pp. 461-470, (2005).
- [56] Liao, C., Guimbretiere, F., and Loeckenhoff, C.: Pentop feedback for paper-based interfaces, *UIST 2006 Proceedings*, Montreux, Switzerland, ACM, pp. 201–210 (2006).
- [57] Lieberman. J.: Accelerated and improved motor learning and rehabilitation us-

References

- ing kinesthetic feedback. *Master's thesis, Massachusetts Institute of Technology*, (2006).
- [58] Luk, J., Pasquero, J., Little, J., MacLean, K., Levesque, V., and Hayward, V.: A role for haptics in mobile interaction: initial design using a handheld tactile display prototype, *CHI 2006 Proceedings*, Quebec, Canada, ACM, Addison-Wesley, pp. 171–180 (2006).
- [59] Mackenzie, I. S.: Movement time prediction in human-computer interfaces, *GI 1992 Proceedings*, Toronto, Canadian Information Processing Society, pp. 140–150 (1992).
- [60] Mackenzie, I.S.: Fitts law as a research and design tool in human-computer interaction. *HumanComputer Interaction* pp. 91-139, (1992).
- [61] MacKenzie, I.S. and Buxton, W.: Extending Fitts law to two-dimensional tasks. *CHI 1992 Proceedings* pp. 219-226, (1992).
- [62] MacKenzie, I.S., Kauppinen, T., and Silfverberg, M.: Accuracy measures for evaluating computer pointing devices. *CHI 2001 Proceedings* pp. 9-16, (2001).
- [63] MacLean, K.E., and Enriquez, M.: Perceptual Design of Haptic Icons, *EuroHaptics 2003 Proceedings*, Dublin, Ireland, pp. 351–363 (2003).
- [64] Moffatt, K., Yuen, S., and Mcgrenere, J.: Hover or Tap ? Supporting Pen-based Menu Navigation for Older Adults. *ASSETS 2008 Proceedings* pp. 51-58, (2008).
- [65] Montagu, Ashley. *Touching: The Human Significance of the Skin. Columbia University Press, New York* (1971).
- [66] Morris, D., and Joshi, N.: Alternative ‘Vision’: A Haptic and Auditory Assistive Device, *CHI 2003 Proceedings*, Lauderdale, Florida, ACM, Addison-Wesley, pp. 966-967 (2003).
- [67] Nashel, A., and Razzaque, S.: Tactile Virtual Buttons for Mobile Devices, *CHI 2003 Proceedings*, Lauderdale, Florida, ACM, Addison-Wesley, pp. 854-855 (2003).

References

- [68] Oshita M.: Pen-to-mime: a pen-based interface for interactive control of a human figure. *EUROGRAPHICS workshop on sketch-based interfaces and modeling* , pp. 43-52 (2004).
- [69] Partridge, K., Chatterjee, S., Sazawal, V., Borriello, G. and Want, R.: TiltType: accelerometer-supported ext entry for very small devices. *UIST 2002 Proceedings* , pp. 201-204 (2002).
- [70] Phantom. <http://www.sensable.com/haptic-phantom-desktop.htm>
- [71] Poupyrev, I., and Maruyama, S., and Rekimoto. J. .: Ambient Touch: Designing tactile interfaces for handheld devices, *UIST 2002 Proceedings*, pp. 51-60 (2002).
- [72] Poupyrev, I., and Maruyama, S.: Tactile interfaces for small touch screens, *UIST 2003 Proceedings*, Vancouver, BC, ACM, pp. 217–220 (2003).
- [73] Poupyrev, I., M. Okabe, and S. Maruyama.: Haptic Feedback for Pen Computing: Directions and Strategies, *CHI 2004 Proceedings*, Vienna, Austria, ACM, Addison-Wesley, pp. 1309–1310 (2004).
- [74] Rahman, M., Gustafson, S., Irani, P. and Subramanian, S.: Tilt techniques: investigating the dexterity of wrist-based input. *CHI 2009 Proceedings*, pp. 1943-1952 (2009).
- [75] Ramos, G. a and Balakrishnan, R.: Zliding: Fluid zooming and sliding for high precision parameter manipulation, *UIST 2000 Proceedings*, pp. 143-152 (2005).
- [76] Ramos, G. a and Balakrishnan, R. Pressure marks. *CHI 2007 Proceedings*, pp. 1375-1384 (2007).
- [77] Rekimoto, J. Tilting operations for small screen interfaces. *UIST 1996 Proceedings*, pp. 167-168 (1996).
- [78] Rekimoto, J., and Sciammarella, E.: ToolStone: Effective Use of the Physical Manipulation Vocabularies of Input Devices, *UIST 2000 Proceedings*, pp. 109-117 (2000).

References

- [79] Sklar, A. E., and Sarter, N. B.: Good Vibrations: Tactile feedback in support of attention allocation and human-automation coordination in event-driven domains, *J. Human Factor*, Vol. 41, No. 4, pp. 543–552 (1999).
- [80] Singer, R. N.: Motor Learning and Human Performance: An Application to Motor Skills and Movement Behavior, *Macmillan Publications*, 3rd Edition, (1980).
- [81] Small, D. and Ishii, H.: Design of spatially aware graspable displays. *CHI 1997 Proceedings*, pp. 367-368 (1997).
- [82] Spelmezan, D., Jacobs, M., Hilgers, A., and Borchers, J. Tactile motion instructions for physical activities. *CHI 2009 Proceedings*, pp. 2243-2252 (2009).
- [83] Srimathveeravalli, G. and Thenkurussi, K.: Motor Skill Training Assistance Using Haptic Attributes. *First Joint Eurohaptics Conference and Symposium on Haptic Interfaces for Virtual Environment and Teleoperator Systems*, pp. 452-457 (2005).
- [84] Subramanian, S., Aliakseyeu, D., and Lucero, A. Multi-layer interaction for digital tables. *UIST 2006 Proceedings* pp. 269-272, (2006).
- [85] Sun, M., Ren, X. and Cao, X.: Effects of Multimodal Error Feedback on Human Performance in Steering Tasks. *Forum on Information Technology 2009* , Sendai, Japan, Vol. 3, pp. 51–56 (2009).
- [86] Suzuki, Y., Misue, K., and Tanaka, J.: Stylus Enhancement to Enrich Interaction with Computers. *12th International Conference on Human-Computer Interaction* . (HCI International 2007), LNCS 4551, pp. 133-142 (2007).
- [87] Szalavari, Zs., Gervautz, M.: The Personal Interaction Panel, *EUROGRAPHICS 1997 Proceedings* , pp. 335-346 (1997).
- [88] Taylor, B. T. and Bove, V. M. (2009). Graspables: grasp- recognition as a user interface. *CHI 2009 Proceedings*, pp. 917-926 (2009).
- [89] Tian, F., Xu, L., Wang, H.: Tilt Menu : Using the 3D Orientation Information of Pen Devices to Extend the Selection Capability of Pen-based User Interfaces. *CHI*

References

- 2008 Proceedings*, pp. 1943-1952 (2008).
- [90] Thurstone, L. L. The Method of Paired Comparison for Social Values. *Journal of Abnormal and Social Psychology*, 21, pp. 384-400, (1927).
- [91] Vitense, H.S., Jacko, J.A., and Emery, V.K.: Foundation for improved interaction by individuals with visual impairments through multimodal feedback. *Universal Access in the Information Society*, 2(1), pp. 76-87 (2002).
- [92] Vitense, H.S., Jacko, J.A., and Emery, V.K.: Multimodal feedback: an assessment of performance and mental workload. *Ergonomics*, 46(1), pp. 68-87 (2003).
- [93] Wacom DTI-520. <http://www.wacom.com.au/price/IPD/DTI520LOC.html> (Accessed 3 December 2009).
- [94] Wacom Intuos3 PTZ-430. <http://www.wacom.com.au/price/intuos3/intuos3A6.html> (Accessed 3 December 2009).
- [95] Wigdor, D. and Balakrishnan, R. (2003). TiltText: using tilt for text input to mobile phones. *Proc. UIST*, pp. 81-90 (2003).
- [96] Wood, P. Scientific Illustration: A Guide to Biological, Zoological, and Medical Rendering Techniques, Design, Printing, and Display, *John Wiley and Sons*, (1994).
- [97] Xin, Y.Z., Bi, X.J., Ren, X.S.: Acquiring and Pointing: An Empirical Study of Pen Tilt-Based Interaction. *to appear in CHI 2011 Proceedings*, (2011).
- [98] Yang, X.-D., Bischof, W.F., and Boulanger, P. Validating the Performance of Haptic Motor Skill Training. *2008 Symposium on Haptic Interfaces for Virtual Environment and Teleoperator Systems*, pp. 129-135 (2008).
- [99] Yang, X. D., Irani, P., Boulanger, P. and Bischof, W. F. A Model for Steering with Haptic-Force Guidance. *INTERACT 2009 Proceedings* , pp. 465-478 (2009).
- [100] Zhai, S. Characterizing computer input with Fitts' law parameters: the information and non-information aspects of pointing. *International Journal Human-Computer Studies*, 61(6), pp. 791-809 (2004).

References

- [101] Zhao, S.D., Dragicevic, P., Chignell, M., Balakrishnan, R., and Baudisch, P.: Earpod: eyes-free menu selection using touch input and reactive audio feedback, *CHI 2007 Proceedings*, San Jose, California, ACM, Addison-Wesley, pp. 1395-1404 (2007).
- [102] Zhou, X. and Ren, X. An Investigation of Subjective Operational Biases in Steering Tasks Evaluation. *Behaviour Information Technology*, 29, pp. 125-135 (2010).

Appendix A

Publications

A.1 Articles in or submitted refereed journals

1. Minghui Sun, Xiangshi Ren and Xiang Cao. “Effects of Multimodal Error Feedback on Human Performance in Steering Tasks”. *Journal of Information Processing (IPSJ)*, Vol. 18, pp.284-292. (2010).
2. Minghui Sun, Xiangshi Ren. “A Comparison of Multimodal Feedback in a Tracking State”. *accepted by Behaviour Information Technology (BIT)*.

A.2 Articles in full paper refereed international conference proceedings

1. Minghui Sun, Xiangshi Ren and Xiang Cao. (2009). “Effects of Multimodal Error Feedback on Human Performance in Steering Tasks”. *Forum on Information Technology 2009 (FIT 2009)*, Sendai, Japan, Sep. 2-4, Vol. 3, pp. 51-56. (FIT paper award)
2. Minghui Sun, Xiangshi Ren. “An Evaluation of Multimodal Feedback in Tracking State for Pen-based Interfaces”, *The 2009 IEEE International Conference on Mechatronics and Automation (ICMA 2009)*, ChangChun, China, August. 9-12, pp. 72-77.
3. Minghui Sun, Xiangshi Ren. “Investigation of Thumb Interface for Menu Selection on Mobile Equipment”, *The Fourth International Conference on Innovative Com-*

A.3 Articles in abstract refereed international conference proceedings

puting, Information and Control (ICICIC 2009), Kaohsiung, Taiwan, Dec. 7-9, pp. 805-809.

4. Minghui Sun, Xiangshi Ren. “An Empirical Comparison of the Locations of Haptic Feedback in Steering Tasks”, *IEEE International Conference on Information and Automation (ICIA 2010)*, Harbin, Heilongjiang, China, June 20-23, pp. 163-166.

A.3 Articles in abstract refereed international conference proceedings

1. Minghui Sun, Xiangshi Ren. (2008). “Comparing the effects of audio, tactile and visual feedback on steering task”, *International Conference on Next Era Information Networking (NEINE 2008)*, Kochi, Japan, 23 December, 2008, pp.386-388.

2. Tomoki Oya, Minghui Sun, Xiangshi Ren. (2008). “Using Tactile Feedback to Improve Human’s Performance in Hovering State of Pens”, *International Conference on Next Era Information Networking (NEINE 2008)*, Kochi, Japan, 23 December, 2008, pp.389-392. (Best student paper award)

3. Minghui Sun, Xiangshi Ren. “An empirical study of error feedback in pen-based interaction”, (*IWIT 2009*). ChangChun, China. Sep. 15-19.

4. Minghui Sun, Xiangshi Ren. “An Investigation of the Relationship between Texture and Human Performance in Steering Tasks”, (*IWIT 2010*). Kochi, Japan. Oct. 20-22.

A.4 Articles in refereed local conference proceedings

1. Minghui Sun, Xiangshi Ren. (2008). “Candidate Display Styles in Chinese Input”. In *Proceedings of SJCIEE2008.*, Tokushima, Japan, Oct. 2008.