

高知工科大学
基礎数学ワークブック
(2002年度版)

Series A

No. 2

解答

< 1 ページ. 分数指数 1 >

問の解答

(1) $121^{\frac{1}{2}} = 11$

(2) $27^{\frac{1}{3}} = 3$

(3) $25^{\frac{3}{2}} = 125$

(4) $343^{\frac{2}{3}} = 49$

(5) $81^{\frac{5}{4}} = 243$

(6) $32^{\frac{4}{5}} = 16$

(7) $16^{-\frac{1}{2}} = \frac{1}{4}$

(8) $27^{-\frac{4}{3}} = \frac{1}{81}$

(9) $64^{-\frac{2}{3}} = \frac{1}{16}$

< 2 ページ. 分数指数 2 >

問 1 の解答

$$(1) \sqrt[6]{4^3} = 2$$

$$(2) \sqrt[12]{7^4} = \sqrt[3]{7}$$

$$(3) \sqrt[3]{5^9} = 125$$

$$(4) \sqrt[6]{27^4} = 9$$

問 2 の解答

$$(1) \sqrt[2]{10} \times \sqrt[4]{100} = \sqrt[4]{10000} = 10$$

$$(2) \frac{\sqrt[3]{9}}{\sqrt[6]{9}} = \sqrt[6]{\frac{9^2}{9}} = \sqrt[3]{3}$$

$$(3) \sqrt{\sqrt[3]{9}} = \sqrt[6]{9} = \sqrt[3]{3}$$

$$(4) \left(\sqrt[3]{\sqrt{27}} \right)^2 = \sqrt[3]{27} = 3$$

< 3 ページ. 指数法則 >

問 1 の解答

正の数 a と b 、および有理数 p と q に対して

$$1^\circ : a^p \times a^q = a^{\boxed{p+q}} \quad , \quad 2^\circ : a^p \div a^q = a^{\boxed{p-q}}$$

$$3^\circ : (a^p)^q = a^{\boxed{pq}} \quad , \quad 4^\circ : (ab)^p = a^p b^p$$

問 2 の解答

$$(1) \sqrt[4]{a} \times \sqrt[4]{a^3} = a$$

$$(2) \sqrt[3]{a^4} \div \sqrt[3]{a} = a$$

$$(3) \left(\sqrt[3]{a}\right)^4 \times \sqrt[3]{a^2} = a^2$$

$$(4) \sqrt[3]{a^7} \div \left(\sqrt[3]{a}\right)^4 = a$$

$$(5) \left(\sqrt[4]{a}\right)^{\frac{8}{3}} = \sqrt[3]{a^2}$$

$$(6) \left(\sqrt[5]{\sqrt[4]{a^{-3}}}\right)^{-2} = \sqrt[10]{a^3}$$

問 3 の解答

$$(1) (3^3 \times 5^2)^{\frac{1}{7}} \times (3^4 \times 5^5)^{\frac{1}{7}} = 3 \times 5 = 15$$

$$(2) \sqrt[4]{18} \times \sqrt[4]{72} = \sqrt[4]{2^4 \times 3^4} = 6$$

< 4 ページ. 指数関数 >

問の解答

(1) $y = 2^x$

x	-2	-1	0	$\frac{1}{2}$	1	2
y	$\frac{1}{4}$	$\frac{1}{2}$	1	$\sqrt{2}$	2	4

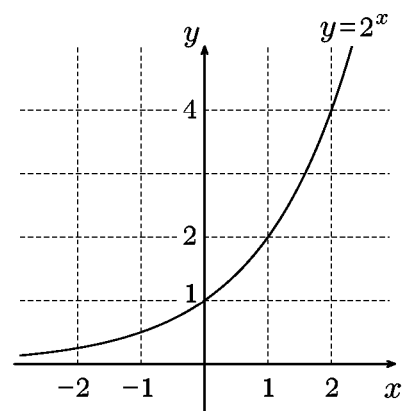

(2) $y = 4^x$

x	-1	$-\frac{1}{2}$	0	$\frac{1}{2}$	1	$\frac{3}{2}$
y	$\frac{1}{4}$	$\frac{1}{2}$	1	2	4	8

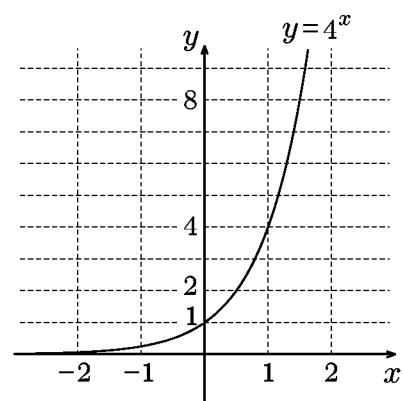

(3) $y = \left(\frac{1}{2}\right)^x$

x	-2	-1	0	1	2
y	4	2	1	$\frac{1}{2}$	$\frac{1}{4}$

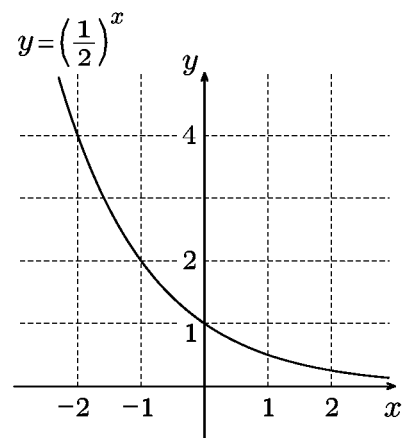

< 5 ページ. 指数方程式 >

問の解答

(1) $x = 0$ (2) $x = 1$ (3) $x = 2$ (4) $x = -1$

(5) $x = \frac{1}{2}$ (6) $x = 0$ (7) $x = 2$ (8) $x = \frac{1}{3}$

(9) $x = -1$ (10) $x = -2$ (11) $x = 0$ (12) $x = 2$

(13) $x = 5$ (14) $x = \frac{1}{4}$ (15) $x = \frac{3}{2}$ (16) $x = -1$

(17) $x = -3$ (18) $x = -2$ (19) $x = -\frac{1}{2}$ (20) $x = 0$

(21) $x = 1$ (22) $x = 3$ (23) $x = 2$ (24) $x = -1$

(25) $x = -2$ (26) $x = -\frac{1}{2}$ (27) $x = 0$ (28) $x = 2$

(29) $x = \frac{1}{2}$ (30) $x = \frac{3}{2}$ (31) $x = -1$ (32) $x = \frac{1}{4}$

< 6 ページ. 対数 1 >

問 1 の解答

$$(1) \frac{1}{2} = \log_2 \sqrt{2}$$

$$(2) -1 = \log_5 \frac{1}{5}$$

$$(3) 3^3 = 27$$

$$(4) 9^{\frac{3}{2}} = 27$$

問 2 の解答

$$(1) \log_2 64 = 6$$

$$(2) \log_3 243 = 5$$

$$(3) \log_{10} 1000 = 3$$

$$(4) \log_5 625 = 4$$

< 7 ページ. 対数 2 >

問 1 の解答

(1) $\log_2 64 = 6$

(2) $\log_2 \sqrt{2} = \frac{1}{2}$

(3) $\log_2 0.5 = -1$

(4) $\log_2 (2\sqrt{2}) = \frac{3}{2}$

(5) $\log_4 64 = 3$

(6) $\log_4 1 = 0$

(7) $\log_6 \sqrt[3]{6} = \frac{1}{3}$

(8) $\log_5 0.2 = -1$

(9) $\log_{10} 0.01 = -2$

(10) $\log_7 \sqrt[3]{49} = \frac{2}{3}$

(11) $\log_2 \left(\frac{1}{\sqrt{2}} \right) = -\frac{1}{2}$

(12) $\log_4 8 = \frac{3}{2}$

問 2 の解答

(証明) $\log_2(M \times N) = \log_2(2^\alpha \times 2^\beta)$

$$= \log_2(2^{\alpha+\beta})$$

$$= \alpha + \beta$$

$$= \log_2(2^\alpha) + \log_2(2^\beta)$$

$$= \log_2 M + \log_2 N$$

よって $\log_2(M \times N) = \log_2 M + \log_2 N$ が成り立つ

< 8 ページ. 対数 3 >

問 1 の解答

$$\text{(証明)} \log_2 \left(\frac{M}{N} \right) = \log_2(2^{\alpha-\beta})$$

$$= \alpha - \beta$$

$$= \log_2(2^\alpha) - \log_2(2^\beta)$$

$$= \log_2 M - \log_2 N$$

よって $\log_2 \left(\frac{M}{N} \right) = \log_2 M - \log_2 N$ が成り立つ

問 2 の解答

$$\text{(証明)} \log_2(M^r) = \log_2(2^{\alpha \times r})$$

$$= \alpha \times r$$

$$= r \times \log_2(2^\alpha)$$

$$= r \times \log_2 M$$

よって $\log_2(M^r) = r \times \log_2 M$ が成り立つ

< 9 ページ. 対数 4 >

問 1 の解答

$$\log_a \left(\frac{M}{N} \right) = \log_a M - \log_a N$$

問 2 の解答

$$\log_a (M^r) = r \times \log_a M$$

問 3 の解答

- (1) $\log_2 12 + \log_2 \frac{1}{3} = \log_2 4 = 2$
- (2) $\log_3 108 - \log_3 4 = \log_3 (27) = 3$
- (3) $\log_6 12 + \log_6 2 + 2 \log_6 3 = \log_6 6^3 = 3$
- (4) $\log_{10} 4 + \log_{10} 25 - \log_{10} 0.1 = \log_{10} = 3$

< 10 ページ. 底の変換 >

問1の解答

$c = b$ とおくと、底の変換より

$$\log_a b = \frac{\log_c b}{\log_c a} = \frac{\log_b b}{\log_b a} = \frac{1}{\log_b a}$$

よって $\log_a b = \frac{1}{\log_b a}$ が成り立つ。

問2の解答

$$(1) \log_4 32 + \log_{16} 64 = \frac{5}{2} + \frac{3}{2} = 4$$

$$(2) (\log_3 4) \times (\log_4 9) = \log_3 9 = 2$$

$$(3) (\log_2 3) \times (\log_3 4) \times (\log_4 2) = \log_2 2 = 1$$

< 11 ページ. 対数関数 >

問の解答

(1) $y = \log_{10} x \quad (x > 0)$

x	0.1	1	$\sqrt{10}$	10
y	-1	0	$\frac{1}{2}$	1

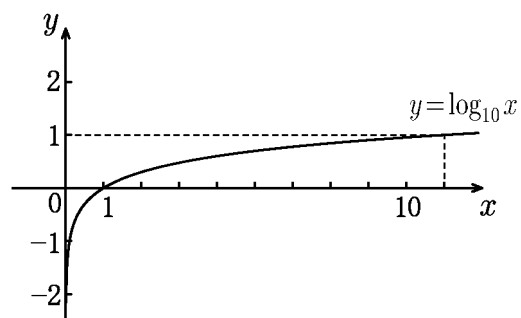
注) $\sqrt{10} \approx 3.16$ 

(2) $y = \log_2 x \quad (x > 0)$

x	$\frac{1}{4}$	$\frac{1}{2}$	1	2	4
y	-2	-1	0	1	2

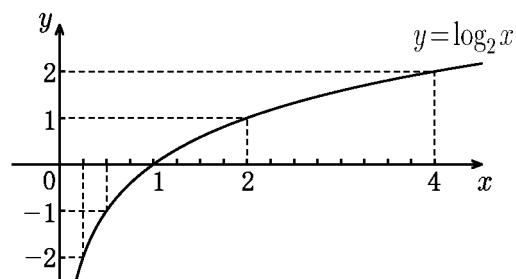

(3) $y = \log_{\frac{1}{2}} x \quad (x > 0)$

x	$\frac{1}{4}$	$\frac{1}{2}$	1	2	4
y	2	1	0	-1	-2

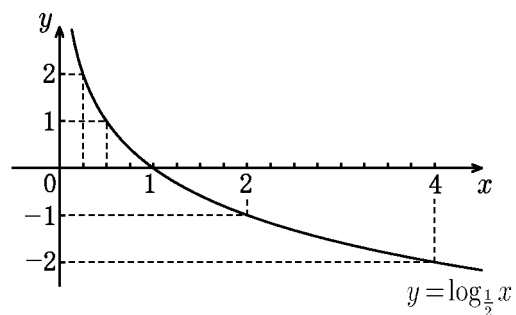

< 12 ページ. 平面上の距離 >

問 1 の解答

$$(1) A(2, 3) , B(6, 1)$$

$$AB = \sqrt{4^2 + 2^2} = 2\sqrt{5}$$

$$(2) A(1, 2) , B(-1, 0)$$

$$AB = \sqrt{2^2 + 2^2} = 2\sqrt{2}$$

$$(3) A(2, -1) , B(-1, -3)$$

$$AB = \sqrt{3^2 + 2^2} = \sqrt{13}$$

問 2 の解答

$$A(x_1, y_1) , B(x_2, y_2)$$

$$AB = \sqrt{(x_2 - x_1)^2 + (y_2 - y_1)^2}$$

< 13 ページ. 円の方程式 >

問 1 の解答

$$\left(x - \boxed{a}\right)^2 + \left(y - \boxed{b}\right)^2 = \boxed{r^2}$$

問 2 の解答

(1) $(x - 1)^2 + (y - 2)^2 = 16$: 中心 (1 , 2) , 半径 = 4

(2) $(x + 2)^2 + (y + 3)^2 = 4$: 中心 (-2 , -3) , 半径 = 2

(3) $x^2 + y^2 = 1$: 中心 (0 , 0) , 半径 = 1

< 14 ページ. 直角三角形 >

問 1 の解答

$$c = \sqrt{a^2 + b^2}$$

問 2 の解答

$$AD = \sqrt{3}$$

問 3 の解答

$$AB = \frac{\sqrt{3}}{2} \qquad BC = \frac{1}{2}$$

問 4 の解答

$$AD = BC = \frac{\sqrt{2}}{2}$$

< 15 ページ. 円周上の点 >**問1の解答**

$$\begin{aligned} & A (1 , 0) \quad , \quad B (0 , 1) \\ & C (-1 , 0) \quad , \quad D (0 , -1) \end{aligned}$$

問2の解答

$$\begin{aligned} & A \left(\frac{\sqrt{2}}{2} , \frac{\sqrt{2}}{2} \right) \quad , \quad B \left(-\frac{\sqrt{2}}{2} , \frac{\sqrt{2}}{2} \right) \\ & C \left(-\frac{\sqrt{2}}{2} , -\frac{\sqrt{2}}{2} \right) \quad , \quad D \left(\frac{\sqrt{2}}{2} , -\frac{\sqrt{2}}{2} \right) \end{aligned}$$

問3の解答

$$\begin{aligned} & A \left(\frac{\sqrt{3}}{2} , \frac{1}{2} \right) \quad , \quad B \left(-\frac{\sqrt{3}}{2} , \frac{1}{2} \right) \\ & C \left(-\frac{\sqrt{3}}{2} , -\frac{1}{2} \right) \quad , \quad D \left(\frac{\sqrt{3}}{2} , -\frac{1}{2} \right) \end{aligned}$$

問4の解答

$$\begin{aligned} & A \left(\frac{1}{2} , \frac{\sqrt{3}}{2} \right) \quad , \quad B \left(-\frac{1}{2} , \frac{\sqrt{3}}{2} \right) \\ & C \left(-\frac{1}{2} , -\frac{\sqrt{3}}{2} \right) \quad , \quad D \left(\frac{1}{2} , -\frac{\sqrt{3}}{2} \right) \end{aligned}$$

< 16 ページ. 三角法 >

問の解答

$$1.5 + 10 \times \frac{1}{\sqrt{3}} = 1.5 + 5.774 = 7.274$$

(答) 7.274_(m)

< 17 ページ. 三角比 1 >

問の解答

$$\sin 30^\circ = \frac{B'C'}{A'B'} = \frac{1}{2}$$

$$\cos 30^\circ = \frac{A'C'}{A'B'} = \frac{\sqrt{3}}{2}$$

$$\tan 30^\circ = \frac{B'C'}{A'C'} = \frac{\sqrt{3}}{3}$$

< 18 ページ. 三角比 2 >

問 1 の解答

$$(1) \frac{BC}{AB} = \frac{\sqrt{2}}{2}, \frac{AC}{AB} = \frac{\sqrt{2}}{2}, \frac{BC}{AC} = 1$$

$$(2) \frac{B'C'}{A'B'} = \frac{\sqrt{2}}{2}, \frac{A'C'}{A'B'} = \frac{\sqrt{2}}{2}, \frac{B'C'}{A'C'} = 1$$

$$(3) \sin 45^\circ = \frac{\sqrt{2}}{2}, \cos 45^\circ = \frac{\sqrt{2}}{2}, \tan 45^\circ = 1, \frac{\sin 45^\circ}{\cos 45^\circ} = 1$$

問 2 の解答

$$(1) \frac{BC}{AB} = \frac{\sqrt{3}}{2}, \frac{AC}{AB} = \frac{1}{2}, \frac{BC}{AC} = \sqrt{3}$$

$$(2) \frac{B'C'}{A'B'} = \frac{\sqrt{3}}{2}, \frac{A'C'}{A'B'} = \frac{1}{2}, \frac{B'C'}{A'C'} = \sqrt{3}$$

$$(3) \sin 60^\circ = \frac{\sqrt{3}}{2}, \cos 60^\circ = \frac{1}{2}, \tan 60^\circ = \sqrt{3}, \frac{\sin 60^\circ}{\cos 60^\circ} = \sqrt{3}$$

< 19 ページ. 三角関数の定義 >

問の解答

$$(1) \sin 180^\circ = 0 \quad , \quad \cos 180^\circ = -1 \quad , \quad \tan 180^\circ = 0$$

$$(2) \sin 270^\circ = -1 \quad , \quad \cos 270^\circ = 0$$

< 20 ページ. 文字式の展開 1 >

問 1 の解答

$$(1) \cos 30^\circ = \frac{\sqrt{3}}{2}$$

$$(2) \sin 30^\circ = \frac{1}{2}$$

$$(3) \tan 30^\circ = \frac{\sqrt{3}}{3}$$

問 2 の解答

$$(1) \cos 60^\circ = \frac{1}{2}$$

$$(2) \sin 60^\circ = \frac{\sqrt{3}}{2}$$

$$(3) \tan 60^\circ = \sqrt{3}$$

問 3 の解答

$$(1) \cos 45^\circ = \frac{\sqrt{2}}{2}$$

$$(2) \sin 45^\circ = \frac{\sqrt{2}}{2}$$

$$(3) \tan 45^\circ = 1$$

問 4 の解答

$$(1) \cos 135^\circ = -\frac{\sqrt{2}}{2}, \quad \sin 135^\circ = \frac{\sqrt{2}}{2}, \quad \tan 135^\circ = -1$$

$$(2) \cos 225^\circ = -\frac{\sqrt{2}}{2}, \quad \sin 225^\circ = -\frac{\sqrt{2}}{2}, \quad \tan 225^\circ = 1$$

$$(3) \cos 315^\circ = \frac{\sqrt{2}}{2}, \quad \sin 315^\circ = -\frac{\sqrt{2}}{2}, \quad \tan 315^\circ = -1$$

< 21 ページ. 三角関数の値 2 >

問 1 の解答

$$(1) \cos 150^\circ = -\frac{\sqrt{3}}{2}, \quad \sin 150^\circ = \frac{1}{2}, \quad \tan 150^\circ = -\frac{\sqrt{3}}{3}$$

$$(2) \cos 210^\circ = -\frac{\sqrt{3}}{2}, \quad \sin 210^\circ = -\frac{1}{2}, \quad \tan 210^\circ = \frac{\sqrt{3}}{3}$$

$$(3) \cos 330^\circ = \frac{\sqrt{3}}{2}, \quad \sin 330^\circ = -\frac{1}{2}, \quad \tan 330^\circ = -\frac{\sqrt{3}}{3}$$

問 2 の解答

$$(1) \cos 120^\circ = -\frac{1}{2}, \quad \sin 120^\circ = \frac{\sqrt{3}}{2}, \quad \tan 120^\circ = -\sqrt{3}$$

$$(2) \cos 240^\circ = -\frac{1}{2}, \quad \sin 240^\circ = -\frac{\sqrt{3}}{2}, \quad \tan 240^\circ = \sqrt{3}$$

$$(3) \cos 300^\circ = \frac{1}{2}, \quad \sin 300^\circ = -\frac{\sqrt{3}}{2}, \quad \tan 300^\circ = -\sqrt{3}$$

問 3 の解答

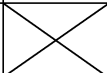
角度 θ	0°	30°	45°	60°	90°	120°	135°	150°
$\sin \theta$	0	$\frac{1}{2}$	$\frac{\sqrt{2}}{2}$	$\frac{\sqrt{3}}{2}$	1	$\frac{\sqrt{3}}{2}$	$\frac{\sqrt{2}}{2}$	$\frac{1}{2}$
$\cos \theta$	1	$\frac{\sqrt{3}}{2}$	$\frac{\sqrt{2}}{2}$	$\frac{1}{2}$	0	$-\frac{1}{2}$	$-\frac{\sqrt{2}}{2}$	$-\frac{\sqrt{3}}{2}$
$\tan \theta$	0	$\frac{\sqrt{3}}{3}$	1	$\sqrt{3}$		$-\sqrt{3}$	-1	$-\frac{\sqrt{3}}{3}$

	180°	210°	225°	240°	270°	300°	315°	330°	360°
	0	$-\frac{1}{2}$	$-\frac{\sqrt{2}}{2}$	$-\frac{\sqrt{3}}{2}$	-1	$-\frac{\sqrt{3}}{2}$	$-\frac{\sqrt{2}}{2}$	$-\frac{1}{2}$	0
	-1	$-\frac{\sqrt{3}}{2}$	$-\frac{\sqrt{2}}{2}$	$-\frac{1}{2}$	0	$\frac{1}{2}$	$\frac{\sqrt{2}}{2}$	$\frac{\sqrt{3}}{2}$	1
	0	$\frac{\sqrt{3}}{3}$	1	$\sqrt{3}$		$-\sqrt{3}$	-1	$-\frac{\sqrt{3}}{3}$	0

< 22 ページ. 極座標表示 >

問の解答

$$(1) (1, \sqrt{3}) = (2 \cos 60^\circ, 2 \sin 60^\circ)$$

$$\text{検算 } (2 \cos 60^\circ, 2 \sin 60^\circ) = \left(2 \times \frac{1}{2}, 2 \times \frac{\sqrt{3}}{2} \right) = (1, \sqrt{3})$$

$$(2) (-2, 2) = (2\sqrt{2} \cos 135^\circ, 2\sqrt{2} \sin 135^\circ)$$

$$\begin{aligned} \text{検算 } (2\sqrt{2} \cos 135^\circ, 2\sqrt{2} \sin 135^\circ) &= \left(2\sqrt{2} \times \left(-\frac{1}{\sqrt{2}} \right), 2\sqrt{2} \times \frac{1}{\sqrt{2}} \right) \\ &= (-2, 2) \end{aligned}$$

$$(3) (-3, -\sqrt{3}) = (2\sqrt{3} \cos 210^\circ, 2\sqrt{3} \sin 210^\circ)$$

$$\begin{aligned} \text{検算 } (2\sqrt{3} \cos 210^\circ, 2\sqrt{3} \sin 210^\circ) &= \left(2\sqrt{3} \times \left(-\frac{\sqrt{3}}{2} \right), 2\sqrt{3} \times \left(-\frac{1}{2} \right) \right) \\ &= (-3, -\sqrt{3}) \end{aligned}$$

$$(4) (3, -3) = (3\sqrt{2} \cos 315^\circ, 3\sqrt{2} \sin 315^\circ)$$

$$\begin{aligned} \text{検算 } (3\sqrt{2} \cos 315^\circ, 3\sqrt{2} \sin 315^\circ) &= \left(3\sqrt{2} \times \frac{1}{\sqrt{2}}, 3\sqrt{2} \times \left(-\frac{1}{\sqrt{2}} \right) \right) \\ &= (3, -3) \end{aligned}$$

< 23 ページ. 余弦定理 1 >

問の解答

$$(1) P (b \cos \theta , b \sin \theta)$$

$$Q (a , 0)$$

$$(2) PQ^2 = (b \cos \theta - a)^2 + (b \sin \theta)^2$$

$$(3) PQ^2 = (b \cos \theta - a)^2 + (b \sin \theta)^2$$

$$= a^2 + b^2 + 2ab \cos \theta$$

$$(4) c^2 = a^2 + b^2 - 2ab \cos \theta$$

< 24 ページ. 余弦定理 2 >

問 1 の解答

$$c^2 = a^2 + b^2 - 2ab \cos \theta$$

問 2 の解答

$$(1) c^2 = 2 + 9 - 6\sqrt{2} \times \frac{1}{\sqrt{2}} = 2 + 9 - 6 = 5$$

$$\underline{c = \sqrt{5}}$$

$$(2) c^2 = 9 + 12 - 12\sqrt{3} \times \left(-\frac{\sqrt{3}}{2}\right) = 9 + 12 + 18 = 39$$

$$\underline{c = \sqrt{39}}$$

< 25 ページ. 一般角 >

問の解答

$$(1) \sin 460^\circ = \sin 100^\circ$$

$$(2) \cos(-70^\circ) = \cos 290^\circ$$

$$(3) \tan 500^\circ = \tan 140^\circ$$

$$(4) \sin(-200^\circ) = \sin 160^\circ$$

$$(5) \cos 650^\circ = \cos 290^\circ$$

$$(6) \tan 860^\circ = \tan 140^\circ$$

< 26 ページ. 三角関数の性質 1 >

問の解答

$$(1) \sin(\theta + 180^\circ) = -\sin \theta$$

$$(2) \cos(\theta + 180^\circ) = -\cos \theta$$

$$(3) \tan(\theta + 180^\circ) = \tan \theta$$

問 2 の解答

$$(1) \sin(-\theta) = -\sin \theta$$

$$(2) \cos(-\theta) = \cos \theta$$

$$(3) \tan(-\theta) = -\tan \theta$$

< 27 ページ. 三角関数の性質 2 >

問 1 の解答

$$(1) \sin(90^\circ - \theta) = \cos \theta$$

$$(2) \cos(90^\circ - \theta) = \sin \theta$$

問 2 の解答

$$(1) \sin 200^\circ = -\sin 20^\circ = -0.342$$

$$\cos 200^\circ = -\cos 20^\circ = -0.9397$$

$$\tan 200^\circ = \tan 20^\circ = 0.364$$

$$(2) \sin -(20^\circ) = -\sin 20^\circ = -0.342$$

$$\cos(-20^\circ) = \cos 20^\circ = 0.9397$$

$$\tan(-20^\circ) = -\tan 20^\circ = -0.364$$

$$(3) \sin 70^\circ = \cos 20^\circ = 0.9397$$

$$\cos 70^\circ = \sin 20^\circ = 0.342$$

< 28 ページ. 三角関数の性質 1 >

問 1 の解答

$$\tan \theta = \frac{\sin \theta}{\cos \theta}$$

問 2 の解答

θ	第 1 象限	第 2 象限	第 3 象限	第 4 象限
$\sin \theta$	+	+	-	-
$\cos \theta$	+	-	-	+
$\tan \theta$	+	-	+	-

問 3 の解答

$$\begin{aligned}\sin \theta &= \sqrt{1 - \cos^2 \theta} \\ &= \sqrt{1 - \left(\frac{12}{13}\right)^2} \\ &= \sqrt{\frac{25}{169}} \\ &= \frac{5}{13}\end{aligned}$$

< 29 ページ. 三角関数表 >

問の解答

$$(1) \sin 100^\circ = \sin 80^\circ = 0.9848$$

$$(2) \tan 220^\circ = \tan 40^\circ = 0.8391$$

$$(3) \cos 320^\circ = \cos 40^\circ = 0.7660$$

$$(4) \sin(-40^\circ) = -\sin 40^\circ = -0.6428$$

$$(5) \cos(-160^\circ) = -\cos 20^\circ = -0.9397$$

$$(6) \tan 500^\circ = -\tan 40^\circ = -0.8391$$

< 30 ページ. 三角方程式 1 >

問の解答

$$(1) \sin \theta = \frac{\sqrt{2}}{2} \quad (0^\circ \leq \theta \leq 360^\circ)$$

$$\underline{\text{(答) } \theta = 45^\circ \text{ または } \theta = 135^\circ}$$

$$(2) \sin \theta = -\frac{\sqrt{3}}{2} \quad (-180^\circ \leq \theta \leq 180^\circ)$$

$$\underline{\text{(答) } \theta = -60^\circ \text{ または } \theta = -120^\circ}$$

$$(3) \sin \theta = -\frac{1}{2} \quad (0^\circ \leq \theta \leq 360^\circ)$$

$$\underline{\text{(答) } \theta = 210^\circ \text{ または } \theta = 330^\circ}$$

< 31 ページ. 三角方程式 2 >

問の解答

$$(1) \cos \theta = \frac{\sqrt{3}}{2} \quad (-180^\circ \leq \theta \leq 180^\circ)$$

$$\underline{\text{(答) } \theta = 30^\circ \text{ または } \theta = -30^\circ}$$

$$(2) \cos \theta = -\frac{1}{2} \quad (-180^\circ \leq \theta \leq 180^\circ)$$

$$\underline{\text{(答) } \theta = 120^\circ \text{ または } \theta = -120^\circ}$$

$$(3) \cos \theta = \frac{\sqrt{2}}{2} \quad (0^\circ \leq \theta \leq 360^\circ)$$

$$\underline{\text{(答) } \theta = 45^\circ \text{ または } \theta = 315^\circ}$$

< 32 ページ. 三角方程式 3 >

問の解答

$$(1) \tan \theta = 1 \quad (-90^\circ \leq \theta \leq 270^\circ)$$

$$\underline{\text{(答) } \theta = 45^\circ \text{ または } \theta = 225^\circ}$$

$$(2) \tan \theta = \frac{1}{\sqrt{3}} \quad (-90^\circ \leq \theta \leq 270^\circ)$$

$$\underline{\text{(答) } \theta = 30^\circ \text{ または } \theta = 210^\circ}$$

$$(3) \tan \theta = -\sqrt{3} \quad (-90^\circ \leq \theta \leq 270^\circ)$$

$$\underline{\text{(答) } \theta = -60^\circ \text{ または } \theta = 120^\circ}$$

< 33 ページ. 三角関数のグラフ 1 >

問1の解答

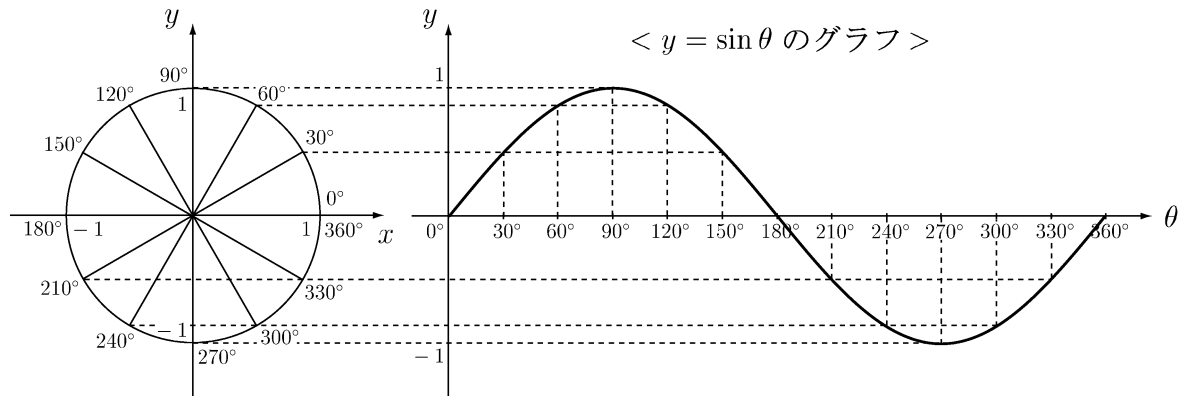

問2の解答

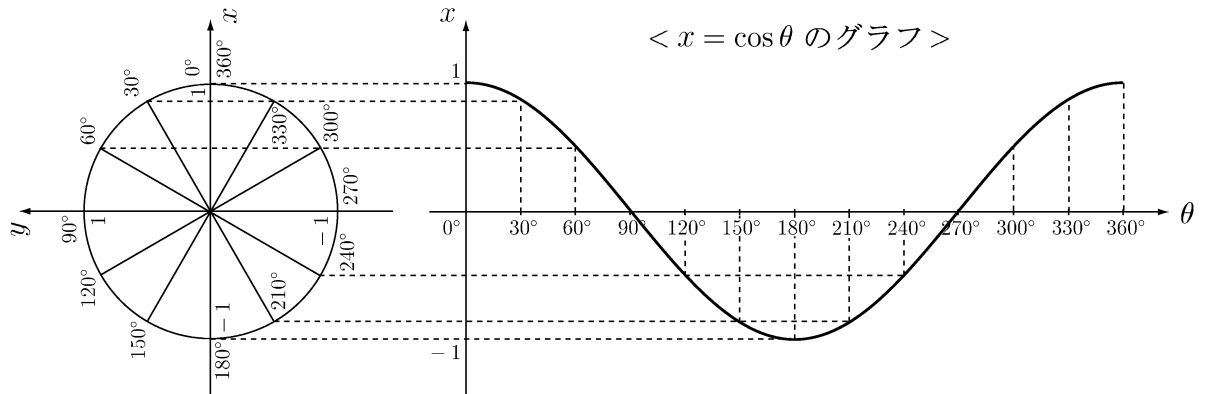

< 34 ページ. 三角関数のグラフ 2 >

問の解答

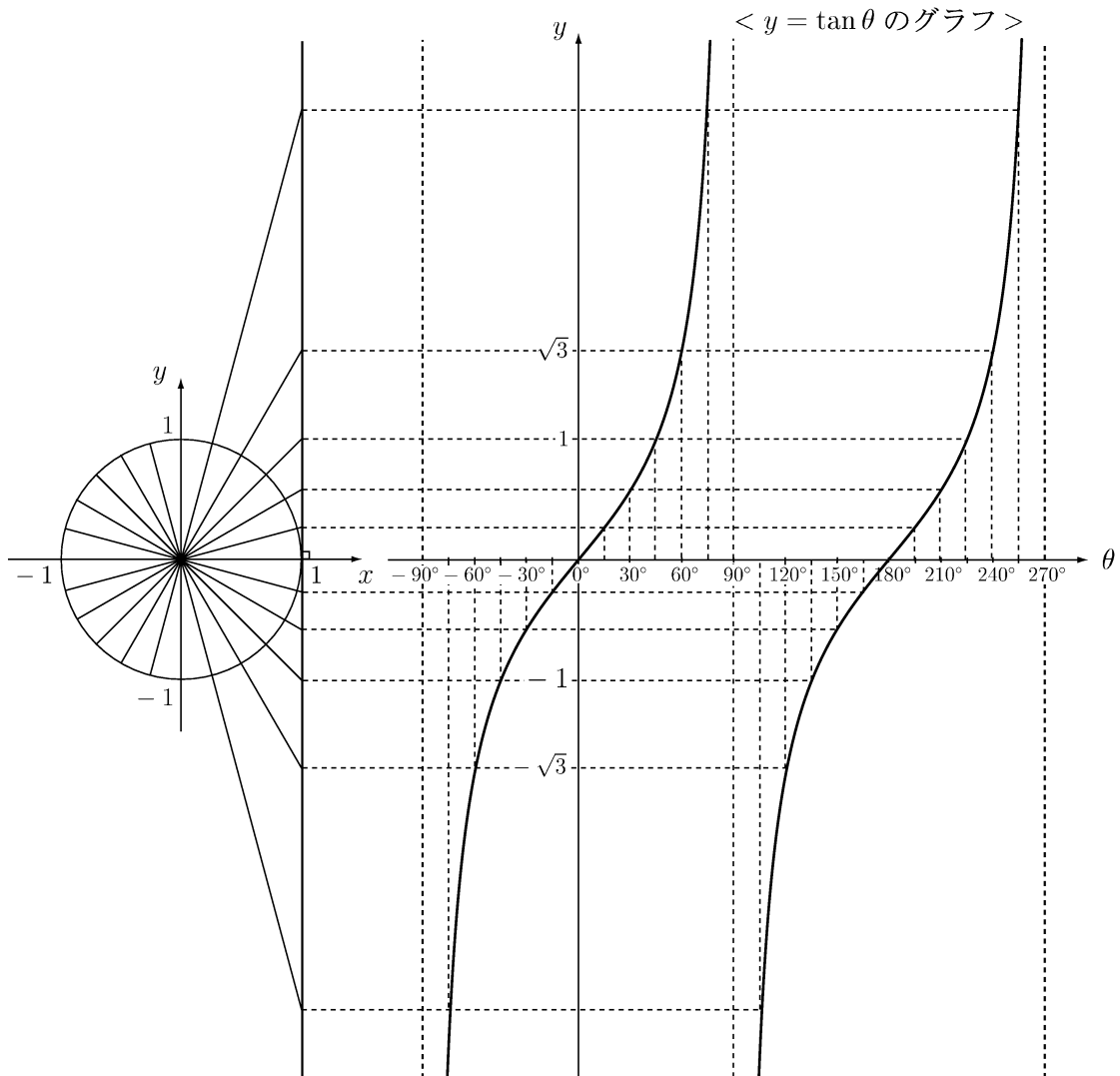

< 35 ページ. 加法定理 1 >

問の解答

$$(1) P(\cos \beta, \sin \beta)$$

$$(2) Q(\cos \alpha, -\sin \alpha)$$

$$(3) PQ^2 = (\cos \alpha - \cos \beta)^2 + (-\sin \alpha - \sin \beta)^2 \\ = \cos^2 \alpha - 2 \cos \alpha \cos \beta + \cos^2 \beta + \sin^2 \alpha + 2 \sin \alpha \sin \beta + \sin^2 \beta$$

$$(4) PQ^2 = (\sin^2 \alpha + \cos^2 \alpha) + (\sin^2 \beta + \cos^2 \beta) - 2 \cos \alpha \cos \beta + 2 \sin \alpha \sin \beta \\ = 2 - 2 \cos \alpha \cos \beta + 2 \sin \alpha \sin \beta$$

$$(5) PQ^2 = 1^2 + 1^2 - 2 \cos(\alpha + \beta) \\ = 2 - 2 \cos(\alpha - \beta)$$

$$(6) \cos(\alpha + \beta) = \cos \alpha \cos \beta - \sin \alpha \sin \beta$$

< 36 ページ. 加法定理 2 >

問の解答

$$\cos 105^\circ = \cos(60^\circ + 45^\circ) = \cos 60^\circ \cos 45^\circ - \sin 60^\circ \sin 45^\circ$$

$$= \frac{1}{2} \times \frac{\sqrt{2}}{2} - \frac{\sqrt{3}}{2} \times \frac{\sqrt{2}}{2} = \frac{\sqrt{2} - \sqrt{6}}{4}$$

$$\sin 105^\circ = \sin(60^\circ + 45^\circ) = \cos(90^\circ - 60^\circ - 45^\circ) = \cos(30^\circ - 45^\circ)$$

$$= \cos 30^\circ \cos(-45^\circ) - \sin 30^\circ \sin(-45^\circ)$$

$$= \frac{\sqrt{3}}{2} \times \frac{\sqrt{2}}{2} - \frac{1}{2} \times \left(-\frac{\sqrt{2}}{2}\right) = \frac{\sqrt{2} + \sqrt{6}}{4}$$

< 37 ページ. 加法定理 3 >

問 1 の解答

$$\sin(\alpha + \beta) = \sin \alpha \cos \beta + \cos \alpha \sin \beta$$

問 2 の解答

$$\begin{aligned} (1) \quad \cos 165^\circ &= \cos 105^\circ \cos 60^\circ - \sin 105^\circ \sin 60^\circ \\ &= \frac{\sqrt{2} - \sqrt{6}}{4} \times \frac{1}{2} - \frac{\sqrt{2} + \sqrt{6}}{4} \times \frac{\sqrt{3}}{2} = \frac{\sqrt{6} + \sqrt{2}}{4} \end{aligned}$$

$$\begin{aligned} (2) \quad \sin 165^\circ &= \sin 105^\circ \cos 60^\circ + \cos 105^\circ \sin 60^\circ \\ &= \frac{\sqrt{2} + \sqrt{6}}{4} \times \frac{1}{2} + \frac{\sqrt{2} - \sqrt{6}}{4} \times \frac{\sqrt{3}}{2} = \frac{\sqrt{6} - \sqrt{2}}{4} \end{aligned}$$

問 3 の解答

$$(1) \quad \cos(\alpha - \beta) = \cos \alpha \cos \beta + \sin \alpha \sin \beta$$

$$(2) \quad \sin(\alpha - \beta) = \sin \alpha \cos \beta - \cos \alpha \sin \beta$$

< 38 ページ. 加法定理 4 >**問 1 の解答**

$$\begin{aligned}\tan 105^\circ &= \frac{\tan 60^\circ + \tan 45^\circ}{1 - \tan 60^\circ \tan 45^\circ} = \frac{\sqrt{3} + 1}{1 - 3} \\ &= \frac{4 + 2\sqrt{3}}{1 - 3} = -2 - \sqrt{3}\end{aligned}$$

問 2 の解答

$$\tan(\alpha + \beta) = \frac{\tan \alpha + \tan \beta}{1 - \tan \alpha \tan \beta}$$

< 39 ページ. 円周率 >**問 1 の解答**

$$(1) \ell = 4\pi \text{ (cm)} \quad (2) \ell = 2\pi r$$

問 2 の解答

$$(1) \pi r \quad (2) \frac{\pi}{2}r \quad (3) \frac{\pi}{3}r$$

< 40 ページ. 弧度法 1 >

問の解答

度数法	0°	30°	45°	60°	90°	120°	135°	150°	180°	210°	225°	240°	270°	300°	315°	330°	360°
弧度法	0	$\frac{\pi}{6}$	$\frac{\pi}{4}$	$\frac{\pi}{3}$	$\frac{\pi}{2}$	$\frac{2}{3}\pi$	$\frac{3}{4}\pi$	$\frac{5}{6}\pi$	π	$\frac{7}{6}\pi$	$\frac{5}{4}\pi$	$\frac{4}{3}\pi$	$\frac{3}{2}\pi$	$\frac{5}{3}\pi$	$\frac{7}{4}\pi$	$\frac{11}{6}\pi$	2π